

J-BERT N4903B High-Performance Serial BERT

7 Gb/s and 12.5 Gb/s



Complete jitter tolerance test for embedded and forwarded clock devices

(USB 3.1 SKP OS filtering)

- Integrated
- Calibrated
- Automated
- Compliant



Keysight Technologies N4900 Series

Keysight offers a wide range of serial bit error ratio test (BERT) solutions for R&D and manufacturing. The J-BERT N4903B high-performance serial BERT is the flagship of Keysight's N4900 serial BERT series. It addresses the needs of R&D and validation teams who characterize serial I/O ports or ASICs up to 14.2 Gb/s. The data rate can be extended up to 28.4 Gb/s by adding a 2:1 multiplexer and demultiplexer with clock data recovery. Integrated and calibrated jitter sources for jitter tolerance measurements allow designers to characterize and prove compliance of their receiver's jitter tolerance.

Keysight's N4900 serial BERT series offers key benefits:

- Excellent precision and sensitivity for accurate measurements
- Choice of feature set and frequency classes to tailor to test needs and budget
- State-of-the-art user interfaces with color touch screen
- Remote control via LAN, USB and GPIB interfaces, compatible with existing command set
Keysight 71612, 81630A Series, N4900 Series
- Small form factor saves rack or bench space

Table 1. BERT applications and selection guide

Device under test	Bit rate	Application examples	Typical requirements	Recommended Keysight BERT	
				For R&D characterization, compliance	For manufacturing compliance
High-speed serial receiver in computer buses and backplanes	< 16 G	QPI, PCI Express®, SATA, SAS, USB3, TBT, DP, MIPI®, D-PHY™/M-PHY®, HDMI, MHL, UHS II, SMI	Data rates < 10-16 Gb/s, calibrated jitter, SSC, ISI and S.I., clock recovery, pattern sequencing	J-BERT M8020A ¹ , J-BERT N4903B, ParBERT 81250 ²	N/A
Backplanes, cables, SERDES, AOC, repeaters	> 10 G - 28 G	100 Gbase-KR4/-CR4, CEI, IB, TBT, CAUI, CAUI 2/4, 10 Gbase-KR	Data rates > 10 Gb/s, de-emphasis, x-talk, PRBS	J-BERT M8020A, M8061A, N4960A, N4965A, J-BERT N4903B, N4877A	N/A
Optical transceivers and sub-components: 0.6 to 44 Gb/s	> 25 G	40 G/100 GbE, 32 G FC, CFP 2/4	Data rates > 16 Gb/s, clean signals, PRBS	N4960A, N4967A J-BERT M8020A/N4903B + M8061A/N4877A	N4960A, N4967A
	10 G	10 G/40 GbE, PON, OTN, 8 G/16 G FC, QSFP, SFP+, QFP	Data rates < 16 Gb/s, fast bit synchronization, PRBS or framed bursts	J-BERT M8020A ¹ , J-BERT N4903B, N4917A ParBERT ²	N2101B, N4906B-012, N4962A
	< 4 G	1 GbE, XFP, PON, 1 G/2 G/4 G FC	Data rates < 3.5 Gb/s, fast bit synchronization, PRBS or framed bursts	N4906B-003, ParBERT 3.3 G	N5980A, ParBERT

1. Up to 4 lanes
2. For multi-lane

Serial BERTs for R&D and validation labs

J-BERT M8020A

The J-BERT M8020A is the new generation high-performance BERT that enables fast and accurate receiver characterization of single- and multi-lane devices operating up to 16 or 32 Gb/s.

J-BERT N4903B

The J-BERT N4903B high-performance serial BERT is the ideal choice for characterization. It offers calibrated jitter tolerance tests fully integrated in a high-performance BERT.

N4960A

The N4960A 17 and 32Gb/s Serial BERT is an affordable and compact Serial BERT. It is the perfect solution to test multiple channels for 100 Gigabit Ethernet applications.

N4967A

The N4967A Serial BERT System allows characterization of optical transceivers operating up to 44 Gb/s.

Serial BERTs for manufacturing test of optical transceivers

N5980A

The N5980A manufacturing serial BERT up to 3.125 Gb/s data rate enables transceiver test at up to one-sixth of the test cost and the front panel size of comparable BERT solutions.

N2101B

The N2101B PXIT manufacturing BERT is a PXI module that has been designed for testing optical transceivers up to 10.3125 Gb/s.

N4906B

The N4906B serial BERT offers an economic BERT solution with excellent signal performance up to 12.5 Gb/s for manufacturing and telecom device testing.

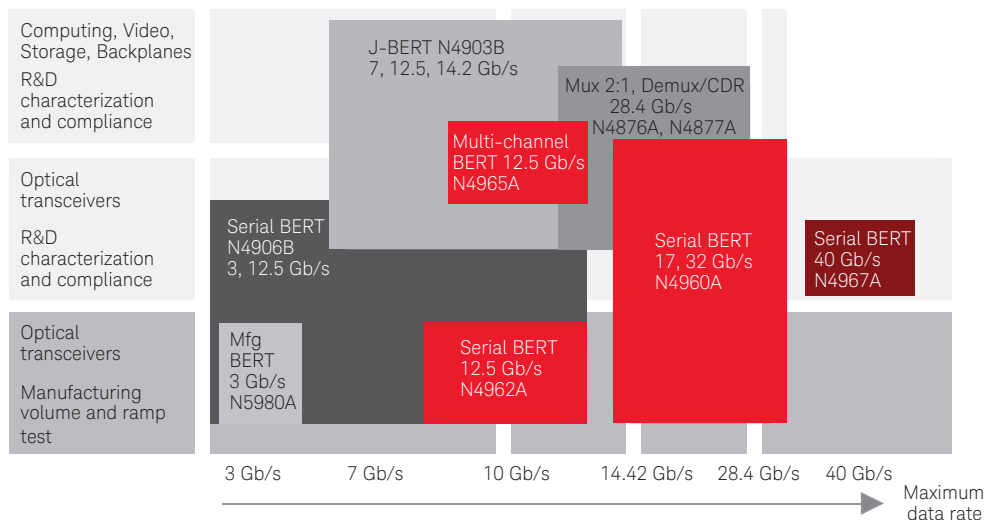

Figure 1. J-BERT is the highest-performance BERT amongst Keysight's offering of serial BERT solutions for R&D and manufacturing

J-BERT N4903B High-Performance Serial BERT

The J-BERT N4903B high-performance serial BERT provides the most complete jitter tolerance test for embedded and forwarded clock devices.

It is the ideal choice for R&D and validation teams characterizing and stressing chips and transceiver modules that have serial I/O ports up to 7 Gb/s, 12.5 Gb/s or even 14.2 Gb/s. It can characterize a receiver's jitter tolerance and is designed to prove compliance to today's most popular serial bus standards, such as:

- PCI Express
- SATA/SAS
- DisplayPort
- USB Super Speed
- MIPI M-PHY
- SD UHS-II
- Thunderbolt
- Fibre Channel
- QPI
- Memory buses, such as fully buffered DIMM2
- Backplanes, such as CEI, IEEE, Infiniband
- 10 GbE/ XAUI
- XFP/XFI, SFP+
- 100 GbE (10x 10G or 4x 25G)

Press the Jitter button to set all jitter parameters you need

Touch screen control of all J-BERT parameters

Remote operation via LAN, GPIB, USB2 or GUI control via built-in web server

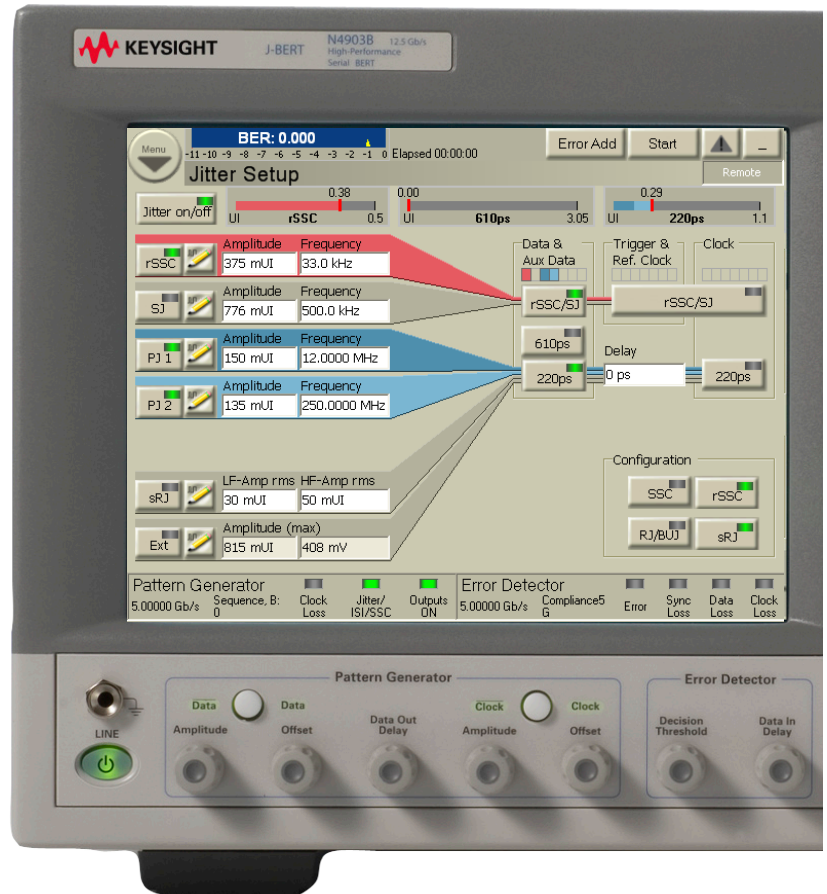

Figure 2. J-BERT N4903B The most complete jitter tolerance test solution for testing embedded and forwarded clock devices

Accurate characterization is achieved with clean signals from the pattern generator, which features exceptionally low jitter and extremely fast transition times. Built-in and calibrated jitter sources allow accurate jitter tolerance testing of receivers.

Test set-up is simplified significantly, because the J-BERT N4903B is designed to match serial bus standards optimally. It offers: differential I/Os, variable voltage levels on all signal outputs, built-in jitter and ISI, pattern sequencer, reference clock outputs, tunable CDR, pattern capture and bit recovery mode to analyze clock-less and non-deterministic patterns.

Faster test execution is possible with J-BERT's automated jitter tolerance tests and fast total jitter measurements.

J-BERT N4903B The Most Complete Jitter Tolerance Test Solution

The J-BERT N4903B is a long-term investment which is configurable for today's test and budget requirements but also allows upgrades from the N4903A model, and later retrofit of all options and full speed when test needs change.

To expand the use of J-BERT a 4-tap de-emphasis, a reference clock multiplier, a 28 Gb/s 2:1 multiplexer, and a 32 Gb/s CDR with de-multiplexer can be added to the setup.

Press Auto Align to automatically adjust the analyzer's sampling point delay and threshold to the center of the eye



Control output voltage of data, aux data, clock, trigger/ref clock individually

Plug-in the interference channel to use the built-in switchable ISI traces and to inject near-end or far-end sinusoidal interference

Recover the clock from incoming data with the built-in CDR with tunable loop bandwidth

J-BERT N4903B The Most Complete Jitter Tolerance Test Solution (continued)

Key capabilities of J-BERT N4903B

- Data rate range from 150 to 7 or 12.5 or 14.2 Gb/s
- Calibrated and built-in jitter and interference sources (SJ, PJ1, PJ2, SSC, residual SSC, arbitrary SSC, RJ, BUJ, cm/dm SI, switchable ISI traces) plus external delay modulation input.
- Supports all clock topologies: embedded clock, forwarded clock and reference clocked
- Second output channel with independent pattern + PRBS
- Excellent signal performance and sensitivity
- Pattern sequencer with 120 blocks, 32Mbit memory and PRBS
- Electrical idle
- Built-in tunable CDR always included
- Error analysis of 8b/10b and 128b/130b coded and packetized data. Filtering of definable filler symbols or PCIe® SKPOS
- Extension to data rates up to 28.4Gb/s possible
- Extension with 4-tap de-emphasis possible
- Available as pattern generator version
- Upgrade path from N4903A

Jitter Tolerance Tests

Calibrated and integrated jitter injection

- Periodic jitter, single and dual-tone (Option J10)
- Sinusoidal jitter (Option J10)
- Random jitter and spectrally distributed RJ (Option J10)
- Bounded uncorrelated jitter (Option J10)
- Intersymbol interference (ISI) (Option J20)
- Sinusoidal interference (Option J20)
- Spread spectrum clocking (SSC) and residual SSC (Option J11)

External jitter injection

Using an external source connected to delay control input.

User controls

Manual jitter composition

Option J10: PJ 1 / 2, SJ, RJ, sRJ, and BUJ

Option J20: ISI and sinusoidal interference

Option J11: SSC and residual SSC

This screen allows the user to set up combinations of jitter types and jitter magnitudes easily. Therefore a calibrated 'stressed eye' with more than 50% eye closure can be set up for receiver testing. Additional jitter can be injected with the interference channel. It adds ISI and differential/single mode sinusoidal interference.

Automated jitter tolerance characterization (Option J10)

This test automatically sweeps over SJ frequency based on the selected start/stop frequency, steps, accuracy, BER level, confidence level and DUT relax time. The green dots indicate where the receiver tolerated the injected jitter. The red dots show where the BER level was exceeded. By selecting a tested point, the jitter setup condition is restored for further analysis. The compliance curve can be shown on the result screen for immediate result interpretation. This automated characterization capability saves significant programming time.

Automated jitter tolerance compliance (Option J12)

This test automatically verifies compliance against a receiver's jitter tolerance curve limits specified by a standard or by the user. Most of the popular serial bus standards define jitter tolerance curves. This option includes a library of jitter tolerance curves for: SATA, Fibre Channel, FB-DIMM, 10 GbE/XAUI, CEI 6/11 G, and XFP/XFI. Pass/fail is shown on a graphical result screen, which can be saved and printed. A comprehensive compliance report, including the jitter setup and total jitter results for each test point, can be generated and saved as a html file for simple jitter tolerance test documentation.

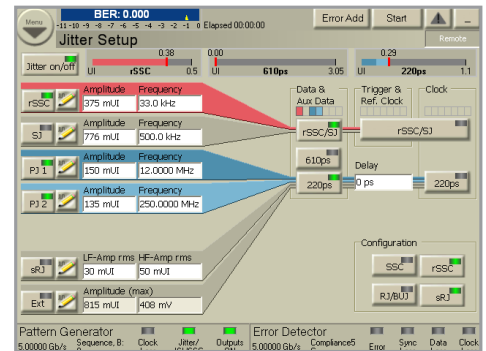

Figure 3. Manual jitter composition. This allows a combination of jitter types to be injected. Example shows a typical jitter setup for a PCIe 2.0 add-in card test

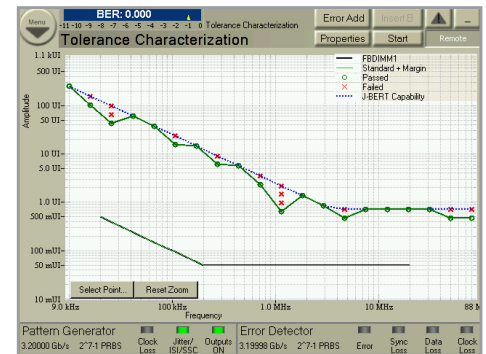

Figure 4. Automated jitter tolerance characterization. The green circles show where DUT works within the required BER-level

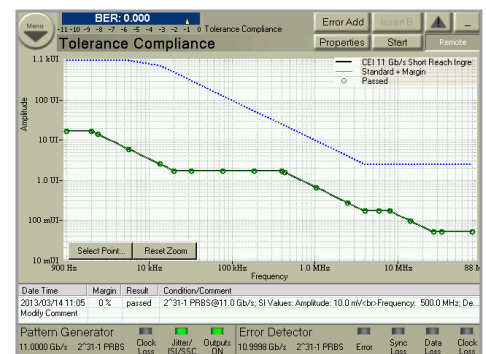

Figure 5. Result screen of the automated jitter tolerance compliance. A library of jitter tolerance curves is available

User Interface and Measurement Suite

Quick eye diagram and masking

The quick eye diagram allows a one-shot check for a valid signal. Due to the higher sampling depth of a BERT, the eye contour lines visualize the measured eye at a deeper BER level for more accurate results. Extrapolated eye contour lines display the eye opening for even lower BER levels, such as 10⁻¹⁵, reducing the measurement time significantly. The display shows numerical results for 1- and 0- level, eye amplitude and width, total jitter and more. Eye masks can be loaded from a library. Violations of the captured eye mask are displayed. The result screen can be printed and saved for documenting the test results (see Figure 6).

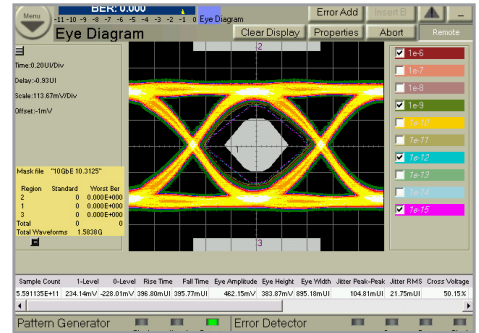

Figure 6. Quick eye diagram with BER contour and masking

Spectral jitter decomposition

The spectral jitter decomposition measures the spectral decomposition of jitter components. When debugging designs, the jitter decomposition simplifies identifying deterministic jitter sources (see Figure 7).

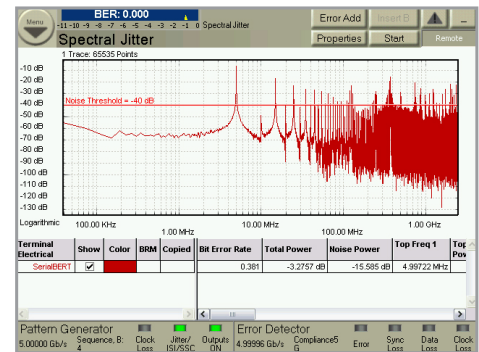

Figure 7. Spectral jitter decomposition for debugging jitter sources in a design

Eye contour

The eye opening is a key characteristic of a device. The BER is displayed as a function of sampling delay and sampling threshold. Different views are available: eye contour (see Figure 8), pseudo colors and equal BER plots.

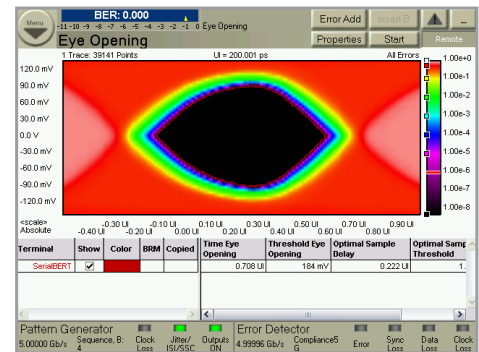

Figure 8. Eye contour with colors indicating BER level

BERT scan including RJ/DJ separation

This measurement shows the BER versus the sampling point delay, which is displayed as a “bathtub” curve or as a histogram. The measurement results are displayed in a table with setup and hold time over phase margin, total jitter in rms or peak-to-peak, and random and deterministic jitter. The measurement method is equivalent to IEEE 802.3ae (see Figure 9).

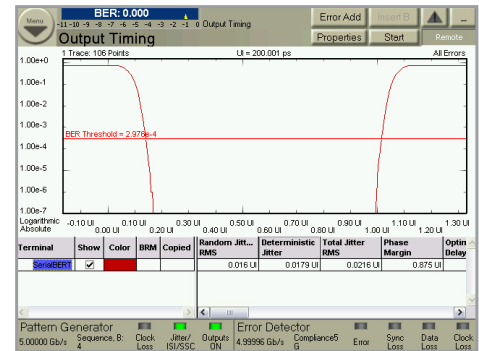

Figure 9. BERT scan including RJ/DJ separation, total jitter

User Interface

Bit recovery mode (Option A01)

This mode is useful for analyzing non-deterministic traffic. This is helpful when you need to analyze real world traffic, for example in a PCI Express link, where so-called 'skip ordered sets' are added unpredictably to avoid FIFO overflow. This simplifies setup by eliminating the need to setup expected data for the error detector. Two analyzer sampling points are used to measure a relative BER, which makes the following measurements possible with relative BER:

- BERT scan including RJ/DJ separation
- Output levels and Q factor
- Eye contour
- Fast eye mask
- Fast total jitter
- Spectral jitter decomposition

Automatic alignment

The J-BERT is able to align the voltage threshold and the delay offset of the sampling point automatically, either simultaneously or separately. It is possible to search for the 0/1 threshold automatically on command, and to track the 0/1 threshold continuously (see Figure 11).

Fast total jitter

Keysight implemented a new measurement technique for TJ (BER), the fast total jitter measurement. This method provides fast and feasible total jitter measurements, around 40 times faster than a common BERT scan but with comparable confidence level. Instead of comparing bits until the BER reaches a defined number of bits or a defined number of errors, it only compares bits until it can decide with a 95% confidence level whether the actual BER is above or below the desired BER (see Figure 12).

Web-based access to GUI

J-BERT can be operated conveniently from any remote web location with the built-in web server. So even without programming knowledge, J-BERT can be operated and monitored from a distance or off-site and in noisy or environmental test labs.

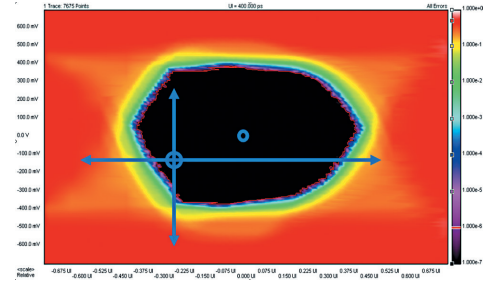

Figure 10. Bit recovery mode for analyzing non-deterministic traffic

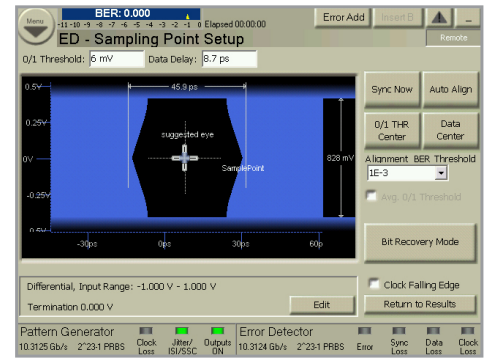

Figure 11. Auto alignment (center) simplifies correct sampling

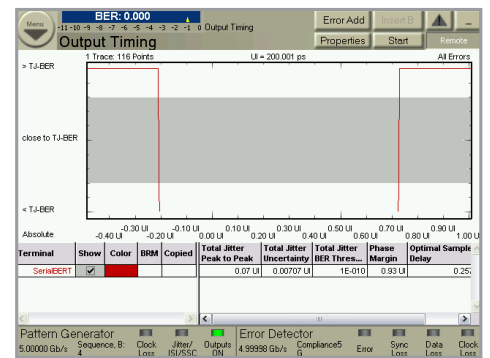

Figure 12. Fast total jitter measurement for quick and accurate total jitter measurements

Pattern Generator Specifications

Bit recovery mode (Option A01)

Pattern generator key characteristics:

- Available as 7 and 12.5 Gb/s pattern generator without error detector (Options G07 and G13), extension to 14.2Gb/s (Option D14)
- Differential outputs with variable output levels for data, aux data, clock and trigger
- Low intrinsic jitter – 800 fs rms
- Transitions times < 20 ps
- Half-rate clock with variable duty cycle (Option 003)
- Pattern sequencer with up to 120 blocks and counted loops
- Second output channel (Option 002)
- Calibrated and integrated jitter injection with SJ, twotone PJ, RJ/sRJ, BUJ, ISI, S.I. (Option J10, J20)
- SSC and residual SSC (Option J11)
- Automated jitter tolerance characterization sweep makes use of SJ and PJ using 610 ps or 220 ps delay line
- High precision delay control input to inject jitter from an external source
- Electrical idle state on data outputs

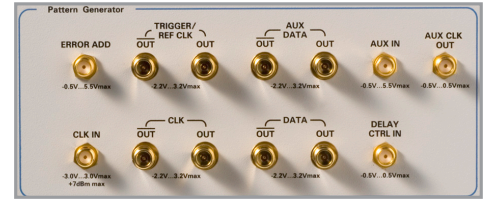

Figure 13. Generator connectors on front panel

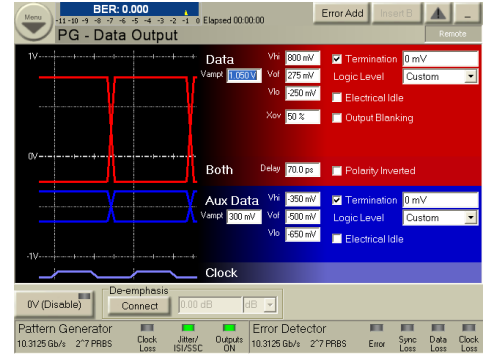

Figure 14. Pattern generator setup screen with graphical display of signal levels and data-to-clock delay

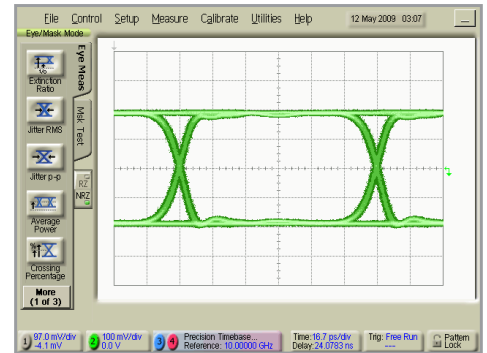

Figure 15. Clean output signal; 10 Gb/s, 400 mV amplitude

Pattern Generator Specifications (continued)

Data output and auxiliary data output (DATA OUT, AUX DATA OUT)

Table 2. Output characteristics for J-BERT N4903B generator. All timing parameters are measured at ECL levels

Range of operation ⁵	150 Mb/s to 14.2 Gb/s (Option D14, required in addition to C13 or G13) 150 Mb/s to 12.5 Gb/s (Option C13 or G13); can be programmed up to 13.5 Gb/s 150 Mb/s to 7 Gb/s (Option C07 or G07); < 620 MHz only with external clock
Frequency accuracy	± 15 ppm typical
Format	NRZ, normal or inverted
Electrical idle	Output transitions from full swing signal to 0 V amplitude and vice versa at constant offset within 4 ns typ. Electrical idle is controlled by the error add input connector
Amplitude/resolution	0.050 V to 1.800 V, 5 mV steps; addresses LVDS, CML, PECL, ECL (terminated to 1.3 V/0 V/-2 V), low voltage CMOS
Output voltage window	- 2.0 V to +3.0 V
Predefined levels	ECL (-2V), SCFL (0V), LVPECL (1.3V), LVDS (1.25V), and CML (0V)
Transition times	
20% to 80%	< 20 ps
10% to 90% ¹	< 25 ps
Intrinsic jitter ⁴	9 ps pp typical with internal clock
Clock/data delay range	± 0.75 ns in 100 fs steps Auto-calibration possible to compensate for temperature drifts
External termination voltage ²	- 2 V to +3 V
Crossing point	Adjustable 20% to 80% typical to emulate duty cycle distortions
AUX data modes:	<ul style="list-style-type: none"> – Sub-rate clock mode: can be used to generate lower rate reference clocks with divider factor n = 2, 3, 4, 5, ... 128 relative to data rate. This is the same function as the sub-rate clock output of N4903A. – Pattern and PRBS generation (Option 002). Can be used to drive a multiplexer such as N4876A (requires SW 6.7 or later) and as independent second data channel (requires SW 7.0 or later).
Skew	< 15 ps typical between data output and aux data output
Single error inject	Adds single errors on demand
Fixed error inject	Fixed error ratios of 1 error in 10 ⁿ bits, n = 3, 4, 5, 6, 7, 8, 9
Interface ³	Differential or single-ended, DC coupled, 50 Ω
Connector	2.4 mm female

1. At 10 Gb/s and 7 Gb/s

2. For positive termination voltage or termination to GND, external termination voltage must be less than 3 V below VOH. For negative termination voltage, external termination voltage must be less than 2 V below VOH. External termination voltage must be less than 3 V above VOL.

3. Unused outputs must be terminated with 50 Ω to GND.

4. At target BER 10⁻⁹, with PRBS 231 -1, 10 Gb/s

5. When Option D14 is enabled, and data rates are > 12.5 Gb/s: PJ1 + PJ2 range 0 to 2.0 UI, modulation frequency range 1 kHz to 100 MHz. RJ range 0 to 20 mUI rms (0 to 280 mUI pp). For BUJ, functionality is not guaranteed and might require manual calibration. For data rates > 13.5 Gb/s SSC, SJ are disabled.)

Pattern Generator Specifications (continued)

Clock output (CLK OUT)

Clock can operate at full bit-rate or at half bit-rate (Option 003) to support testing of forward clocked devices.

Table 3. Clock output specifications

Frequency range	150 MHz to 14.2 GHz (Option D14, in addition to C13 or G13); 150 MHz to 12.5 GHz (Option C13 or G13); can be programmed up to 13.5 GHz 150 MHz to 7 GHz (Option C07 or G07); < 620 MHz only with external clock
Half-rate clocking	Only with Option 003: Available at bit rates > 2.7 Gb/s; duty cycle on half-rate clock adjustable 40% to 60%
Amplitude/resolution	0.050 V pp to 1.800 V pp, 5 mV steps
Output voltage window	-2.00 to +3.00 V
Transition times	
20% to 80%	< 20 ps
10% to 90% ¹	< 25 ps
External termination voltage	-2 V to +3 V
Jitter	800 fs rms typical with internal clock
SSB phase noise	< -75 dBc with internal clock source, 10 GHz at 10 kHz offset, 1 Hz bandwidth
Interface ³	Differential or single-ended, DC coupled, 50 Ω output impedance
Connector	2.4 mm female

- At 10 Gb/s and 7 Gb/s
- For positive termination voltage or termination to GND, external termination voltage must be less than 3 V below VOH. For negative termination voltage, external termination voltage must be less than 2 V below VOH. External termination voltage must be less than 3 V above VOL.
- Unused outputs must be terminated with 50 Ω to GND.

Clock input (CLK IN)

There are two modes when using the clock input connector.

- External clock mode: all output signals follow the external clock and its modulation. The modulation of the external clock must be within the same range given for SSC and SJ (see Table 12). If the external clock is above 6.75 GHz, all internal jitter sources can be used (for using 610 ps delay line, external clock divider $z = 4$). Below 6.75 GHz, SJ and SSC are not available. However, the external clock can optionally be divided by 1, 2, 4, 8, or 16, provided that the resulting bit rate does not fall below 150 Mb/s. Modulation using the 220 ps delay line is still available (see Figure 22).
- External PLL mode: it is used to lock the generator to an external clock. The provided clock must not be modulated in external PLL mode. All internal jitter sources are available. A clock multiplication with x/y is possible, with $x, y = 1, 2, 3$, to 255. The resulting bit rate has to be within the range 620 Mb/s to maximum bit rate.

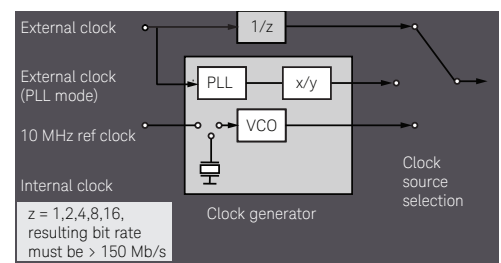

Figure 16. N4903B supports multiple clock modes

Pattern Generator Specifications (continued)

10 MHz reference input (10 MHz REF IN)

This is used to lock the generator to an external 10 MHz reference clock. The data rate can be selected within the same range as if the internal clock would be used. The provided reference clock must not be modulated. All internal jitter sources are available.

Table 4. Specifications for clock input and 10 MHz reference input

Amplitude	200 mV to 2 V
Frequency	CLK IN: 150 MHz to 12.5 GHz (14.2 GHz for Option D14) 10 MHz REF IN: 10 MHz
Interface	AC coupled, 50 Ω nominal
Connectors	
Clock input	SMA female, front panel
10 MHz reference input	BNC, rear panel

Delay control input (DELAY CTRL IN)

The external signal applied to delay control input varies the delay between data output and clock output. This can be used to generate jittered signals to stress the device under test in addition to the calibrated jitter injection from N4903B.

Table 5. Specifications for delay control input

Range	-110 ps to +110 ps
Sensitivity	Typical
Linearity	$\pm 5\%$ typical
Modulation bandwidth	1 GHz typical at 10.8 Gb/s data rate
Levels	-275 mV to +275 mV
Interface	DC coupled, 50 Ω nominal
Connector	SMA female

Error add input (ERROR ADD)

The external error add input adds a single error to the data output for each rising edge at the input. When electrical idle is selected for the data and aux data outputs: a logical high state causes the output to transition to electrical idle state. A logic low state causes the outputs to return to normal operation.

Table 6. Specifications for error inject input

Levels	TTL compatible
Interface	DC coupled, 50 Ω nominal
Connector	SMA female

Pattern Generator Specifications (continued)

10 MHz reference output (10 MHZ REF OUT)

The external error add input adds a single error to the data output for each rising edge at the input. When electrical idle is selected for the data and aux data outputs: a logical high state causes the output to transition to electrical idle state. A logic low state causes the outputs to return to normal operation.

Table 7. Specifications for the 10 MHz reference output

Amplitude	1 V into 50 Ω typical
Interface	AC coupled, 50 Ω output impedance
Connector	BNC, rear panel

Trigger/reference clock outputs (TRIGGER/ REF CLK OUT)

This output provides a trigger signal synchronous with the pattern, for use with an oscilloscope or other test equipment. Typically there is a delay of 32 ns between trigger and data output for data rates > 620 Mb/s. The trigger output has two modes.

Pattern trigger mode: For PRBS patterns; the pulse is synchronized with a user specified trigger pattern. One pulse is generated for every 4th PRBS pattern.

Divided clock mode: Generates a square wave (clock) with the frequency of the full-rate clock divided by 2, 4, 8, 10, 16, 20, 24, 25, 26, up to 32,792. It is possible to enable/disable SJ, SSC or residual SSC for this output to use it as a lower frequency reference clock.

Table 8. Specifications for trigger/reference clock output

Pulse width	Square wave
Amplitude/ resolution	0.050 V to 1.800 V, 5 mV steps. Addresses LVDS, CML, PECL, ECL (terminated to 1.3V/0 V/-2 V), low voltage CMOS
Output voltage window	- 2.0 V to +3.0 V
Predefined levels	ECL, PECL (3.3V), LVDS, CML
Transition times	< 20 ps typical (20% to 80%) < 25 ps typical (10% to 90%)
Interface ¹	DC coupled, 50 Ω nominal, Single ended or differential
Connector	2.4 mm female

1. Unused output must be terminated with 50 Ω to GND.

Pattern Generator Specifications (continued)

AUX input (AUX IN)

When the alternate pattern mode is activated, the memory is split into two parts, and the user can define a pattern for each part. Depending on the operating mode of the auxiliary input, the user can switch the active pattern in real time by applying a pulse (mode 1) or a logical state (mode 2) to the auxiliary input. If the alternate pattern mode is not activated, the user can suppress the data on the data output by applying a logical high to the auxiliary input (mode 3).

Table 9. Specifications for auxilliary input

Levels	TTL compatible
Interface	DC coupled, 50 Ω nominal
Connector	SMA female

Auxillary clock output (AUX CLK OUT)

This output is intended as clock input for N4916B de-emphasis signal converter and the 28 Gb/s 2:1 multiplexer N4876A.

Table 10. Specifications for auxillary clock output

Output level	> 150 mV typical
Clock signal	Full-rate
Interface	AC coupled, 50 Ω nominal
Connector	SMA female

Pattern Generator Specifications (continued)

Library of pre-defined patterns

Many popular compliance patterns are predefined, such as: CJTPAT, CJPAT, DisplayPort, FDDI, Fibre Channel, K28.5, PCI Express, SAS, SATA, SDH, SONET, USB3

Patterns

PRBS: $2n-1$ with $n = 7, 10, 11, 15, 23, 31$, and $2n$ with $n = 7, 10, 13, 15, 23, 31$.

User definable pattern: 32 Mbit, independent for pattern generator and error detector.

Generator pattern sequencing

The generators pattern sequences can be started on command or by a signal applied to the auxiliary input.

Sum of blocks and counted loops: Up to 120; the block resolution of user definable pattern is 512 bits.

Loops: Over 120 or fewer blocks, 1 loop level, loop counter and infinite.

Second output channel (Option 002): In MUX-mode the multiplexed PG pattern can be entered directly. In independent channel mode individual 32 MB patterns and individual PRBS can be set up for the data output and aux data output. The pattern sequence (block length, loops, conditions) applies for main output and the aux output.

The error detector pattern can track patterns from the data out or from the aux data output. Requires software revision 7.0 or later.

Alternate pattern

This allows switching between two patterns of equal length that have been programmed by the user, each of which can be up to 16 Mbit. Switching is possible using a front panel key, over GPIB or by applying the appropriate signal to the auxiliary input port. Changeover occurs at the end of the pattern. The length of the alternating patterns should be a multiple of 512 bits. Two methods of controlling pattern changeover are available: one-shot and alternate.

Zero substitution

Zeros can be substituted for data to extend the longest run of zeros in the patterns listed below. The longest run can be extended to the pattern length-1. The bit following the substituted zeros is set to 1.

Variable mark density

The ratio of ones to total bits in the predefined pattern library can be set to 1/8, 1/4, 1/2, 3/4, or 7/8.

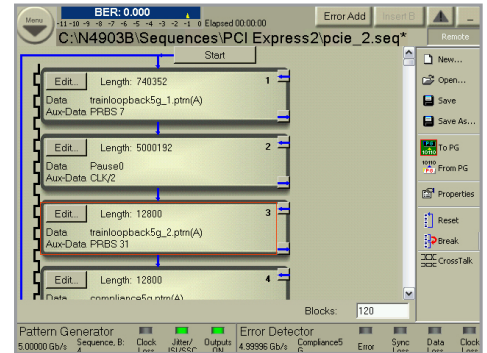

Figure 17. Pattern generator sequencer helps to set up complex training sequences

Jitter Tolerance Test Specifications

The built-in jitter sources are designed to cover DisplayPort, PCI Express, SATA, USB3, Fibre Channel, QPI, FB-DIMM, CEI 6 G/11 G, 10 GbE and XFP/XFI, SFP+ jitter tolerance test needs.

Periodic jitter (Option J10)

This injects sinusoidal, rectangular or triangular jitter over a wide frequency range.

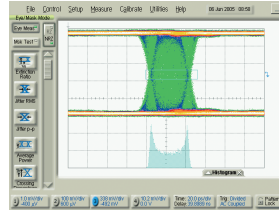

Table 11. Specifications for periodic jitter (PJ1, PJ2)

Range ¹	0 to 220 ps pp at all data rates 0 to 610 ps pp at data rates ≤ 3.375 Gb/s
Modulation frequency	One- and two-tone possible
Sine	1 kHz to 300 MHz
Triangle/square	1 kHz to 20 MHz
Modulation frequency accuracy	0.5% ± 25 Hz typical
Jitter amplitude accuracy	10% ± 1 ps typical
Impacted signals	610 ps delay line: only on data and aux data outputs 220 ps delay line: user selectable for data and aux data outputs, clock output
Jitter delay	0 to ±2.2 ns, 100 ps steps between jitter on data and aux data output versus jitter on clock output for all jitter sources using the 220 ps delay line.

1. Available range depends on modulation frequency and data rate (see Figures 18 and 19).

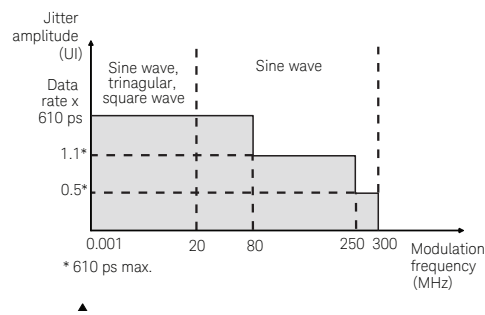

Figure 18. Periodic jitter maximum for data rates ≤ 3.375 Gb/s using the 610 ps delay line

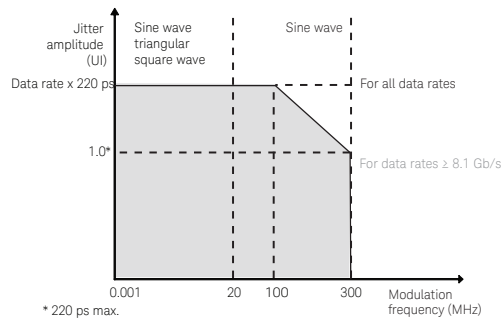

Figure 19. Periodic jitter maximum using the 220 ps delay line

Jitter Tolerance Test Specifications (continued)

Auxillary clock output (AUX CLK OUT)

The built-in SSC clock modulation source is available only in combination with Option J10. It either generates a frequency modulated clock signal (SSC) or a phase modulated clock signal (residual SSC) as used in some computer or storage standards such as PCIe, USB and SATA to spread EMI. If residual SSC is enabled, sinusoidal jitter is not available, however all other jitter sources can be used. If SSC is enabled, sinusoidal jitter is available in a limited range, however all other jitter sources can be used without restrictions. $SSC (\% \text{ of max}) + SJ (\% \text{ of max}) \leq 100\%$.

Table 12. Spread spectrum clocking (SSC) characteristics

SSC frequency deviation: up-spread/ down-spread	0 to -0.5% (5,000 ppm), 2% typical accuracy
SSC frequency deviation: center-spread	0 to 1.0% pp (10,000 ppm), 2 % typical accuracy. Can be used also for down-spread SSC, allowing more SJ range
Residual SSC phase modulation	0 to 100 ps
Modulation frequency	100 Hz to 100 kHz
Modulation waveform	Triangular or arbitrary. Arbitrary files can be uploaded as txt file. Values from -1.0 to +1.0 for 1.0% center-spread modulation, maximum of 16384 data points
Signals impacted	Can be enabled for either data and aux data output and/or clock output and trigger/ref clock out

Jitter Tolerance Test Specifications (continued)

Sinusoidal jitter (Option J10)

This injects sinusoidal jitter in the lower frequency range with multiple UIs.

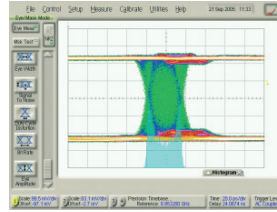

Table 13. Specifications for sinusoidal jitter (SJ)

Range ¹	2 UI at 5 MHz 1000 UI at 10 kHz For frequencies between 10 kHz and 5 MHz the jitter amplitude $\frac{10 \text{ MHz}}{n}$ = $n \times f \text{ (mod) UI}$
Modulation frequency	100 Hz to 5 MHz (For higher modulation frequencies, see Table 10)
Modulation frequency accuracy	0.5% typical
Jitter amplitude accuracy	2% ± 1 ps typical
Impacted signals	User selectable for data and aux data outputs, clock output and trigger/ref clock output.

1. Available range depends on modulation frequency and data rate (see Figure 20).

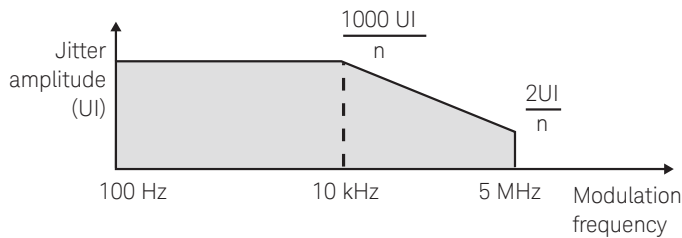

Figure 20. Sinusoidal jitter maximum UI

Data rate	n	Max UI at modulation frequency 100 Hz to 10 kHz	Max UI at modulation frequency 5 MHz
6.75 Gb/s to 12.5 Gb/s	n = 1	1000 UI	2 UI
3.375 Gb/s to 6.75 Gb/s	n = 2	500 UI	1 UI
1.6875 Gb/s to 3.375 Gb/s	n = 4	250 UI	0.5 UI
843,75 Mb/s to 1.6875 Gb/s	n = 8	125 UI	0.25 UI
620 Mb/s to 843.75 Mb/s	n = 16	62.5 UI	0.125 UI

Jitter Tolerance Test Specifications (continued)

Random jitter (Option J10)

This injects random jitter with a high bandwidth and excellent crest factor.

It also allows injecting a spectrally distributed random jitter profile, as required for PCIe 2.0 receiver test.

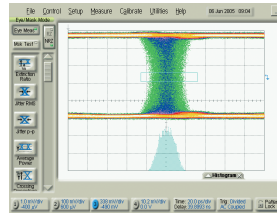

Table 14. Specifications for random jitter (RJ)

Range	<ul style="list-style-type: none"> - 0 to 15.7 ps rms (0 to 220 ps pp) at data rates < 8.1 Gb/s - 0 to 72 mUI (0 to 1UI pp) at data rates ≥ 8.1 Gb/s - 0 to 8 ps rms (0 to 112 ps pp) if 100 MHz low-pass filter is turned on
sRJ	If spectrally distributed random jitter (sRJ) is used, the same limits apply to the square root sum of LF-RJ and HF-RJ components. See Figure 21.
Crest factor	14 (pp to rms ratio)
Bandwidth	50 kHz to 1 GHz
Filter	<ul style="list-style-type: none"> - 10 MHz high-pass - 100 MHz low-pass - 500 MHz low-pass - Can be turned on or off individually to limit jitter bandwidth
Jitter amplitude accuracy	10% ± 0.2 ps typical

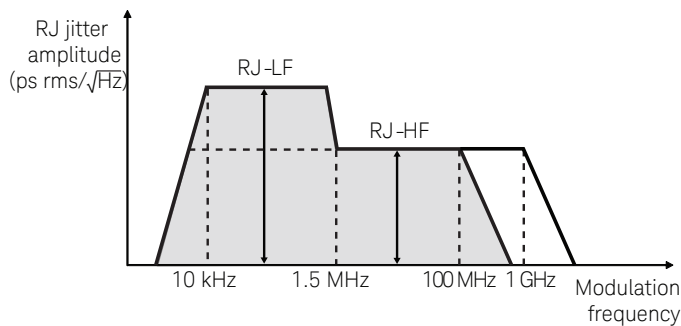

Figure 21. Spectrally distributed RJ allows to inject low frequency and high frequency RJ: this is required for compliant PCIe 2 receiver testing

Jitter Tolerance Test Specifications (continued)

Bounded uncorrelated jitter (Option J10)

This injects a high probability jitter using a PRBS generator and low-pass filters.

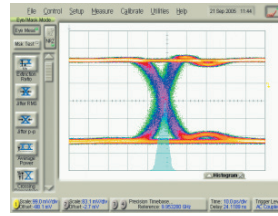

Table 15. Specifications for bounded uncorrelated jitter (BUJ)

Range	0 to 1.1 UI (not to exceed capability of delay line used)
PRBS polynomials	$2^n - 1$; $n = 7, 8, 9, 10, 11, 15, 23, 31$
Data rate of PRBS generator	200 Mb/s to 3.2 Gb/s
Filters	50/100/200 MHz lowpass 3rd order
Jitter amplitude accuracy	$10\% \pm 1$ ps typical for settings shown in Table 15.

Table 16. BUJ accuracy applies for these BUJ calibration settings

BUJ calibration setting ¹	Data rate for PRBS generator	PRBS	Filter
CEI 6G	1.1 Gb/s	PRBS 29 - 1	100 MHz
CEI 11G	2 Gb/s	PRBS 211-1	200 MHz
Gaussian	2 Gb/s	PRBS 231-1	100 MHz

1. Other settings are not calibrated and do not necessarily generate the desired jitter histograms for all datarates of the PRBS generator.

Total jitter

A combination of internally generated SJ/SSC/rSSC, PJ, RJ, BUJ and external jitter (injected using external delay control input) is possible.

The overall jitter composition does reduce the available jitter budget of the respective jitter sources.

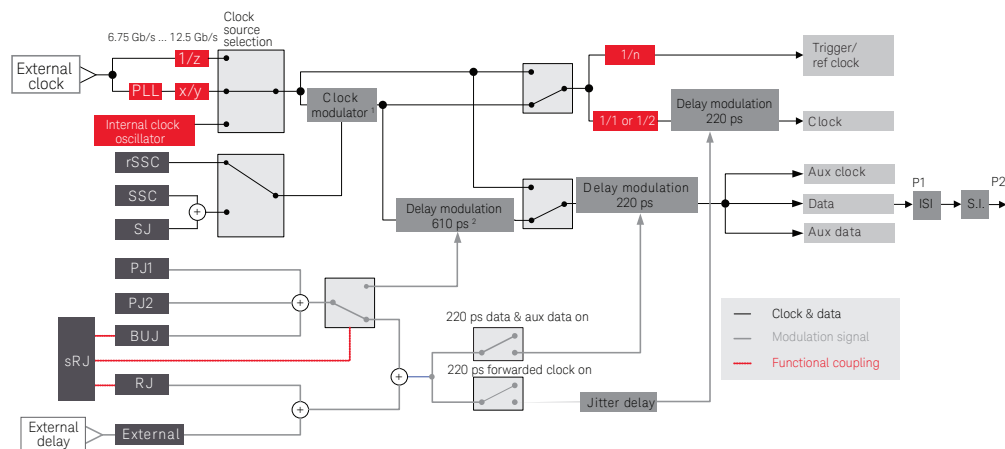

Figure 22. Overview of jitter injection capabilities

1. When using the clock modulator in external clock mode, the external clock must be > 6.75 GHz.
2. When using the 610 ps delay line in external clock mode, the external clock must be > 6.75 GHz and $z = 4$.

Jitter Tolerance Test Specifications (continued)

Interference channel (Option J20)

The Option J20 is only available in addition to Option J10. It includes the semi-rigid cable set to connect data outputs to P1 and P1 (N4915A-008).



Figure 23. Interference channel connectors

Interference channel input and output (P1, P2)

User selectable board traces are switched into the signal path to emulate a backplane

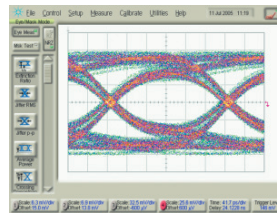

Table 17. Specifications for inter symbol interference (ISI)

Trace length	3.5" (minimum), 9" (minimum with S.I. enabled) 16", 20", 24", 28", 32", 36", 40", 44" inches of board trace type Nelco 4000-6. When using in combination with sinusoidal interference, minimum trace length is 9 inches
S ²¹ parameter	See Figure 24
Range	See Table 17
Max input levels	-5.5 V to +5.5 V
Connectors	2.4 mm, female

Table 18. Typical ISI (measured in UI) for traces depending on data rate, pattern and trace length

Data rate	1.25 Gb/s			2.5 Gb/s			3.125 Gb/s			5 Gb/s			6.25 Gb/s			11 Gb/s		
	PRBS 2 ⁷ -1	PRBS 2 ¹⁵ -1	CJPAT	PRBS 2 ⁷ -1	PRBS 2 ¹⁵ -1	CJPAT	PRBS 2 ⁷ -1	PRBS 2 ¹⁵ -1	CJPAT	PRBS 2 ⁷ -1	PRBS 2 ¹⁵ -1	CJPAT	PRBS 2 ⁷ -1	PRBS 2 ¹⁵ -1	CJPAT	PRBS 2 ⁷ -1	PRBS 2 ¹⁵ -1	CJPAT
3.5 inches													0.062	0.043	0.101	0.133	0.109	
9 inches	< 0.050			0.051			0.070			0.099	0.138	0.096	0.130	0.185	0.126	0.389	0.501	0.378
16 inches				0.095	0.129	0.094	0.123	0.171	0.119	0.264	0.348	0.280	0.348	0.468	0.393			
20 inches		0.068	0.051	0.139	0.180	0.134	0.183	0.263	0.171	0.393	0.507	0.400	0.532					
24 inches	0.069	0.091	0.071	0.181	0.238	0.198	0.253	0.357	0.253	0.491								
28 inches	0.094	0.123	0.097	0.253	0.319	0.261	0.342	0.479	0.351									
32 inches	0.118	0.151	0.126	0.313	0.398	0.318	0.440	0.584	0.446									
36 inches	0.150	0.189	0.157	0.391	0.503	0.410	0.510											
40 inches	0.182	0.227	0.191	0.469	0.597	0.496												
44 inches	0.213	0.267	0.220	0.564														

Jitter Tolerance Test Specifications (continued)

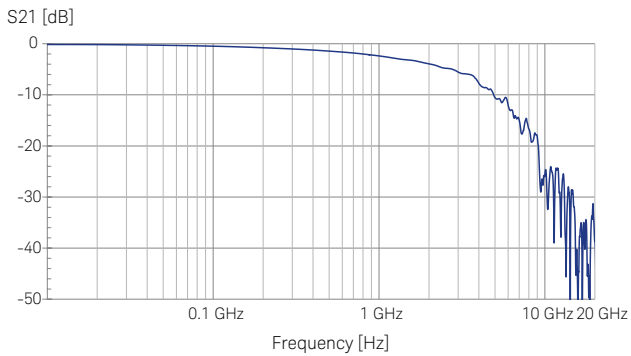

Figure 24. Typical S21 parameter for ISI channel of 9 inch length

Sinusoidal interference (Option J20)

This adds common mode, differential or single-ended sinewave signal on top of the data outputs, to test common mode rejection of a receiver and to emulate vertical eye closure. Sinusoidal interference is injected before the signal passes through the ISI board traces (“near end”) when using P1 as input. For “far end” injection P2 has to be used as input.

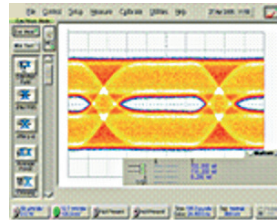

Table 19. Specifications for sinusoidal interference (SI)

Amplitude ¹	0 to 400 mV common mode, single ended and differential (differential amplitude 0 to 800 mV)
Frequency	10 MHz to 3.2 GHz in 100 kHz steps
Level accuracy	± 10% ± 10 mV typical

1. The output signal amplitude is reduced by 3 dB when sinusoidal interference is enabled.

Error Detector Specifications

Error detector key characteristics:

- True differential inputs to match today's ports
- Built-in CDR with tunable loop-bandwidth up to 12 MHz
- Auto-alignment of sampling point
- Bit recovery mode for unknown data traffic (Option A01)
- SER/FER analysis of coded and retimed data (Option A02)
- Burst mode for testing recirculating loop
- BER result and measurement suite
- Quick eye diagram and mask with BER contours

Data inputs (DATA IN)

Table 20. Specifications for error detector

Range of operation	150 Mb/s to 12.5 Gb/s (Option C13) 150 Mb/s to 7 Gb/s (Option C07)
Format	NRZ
Max. input amplitude	2.0 V
Termination voltage ¹	-2 V to +3 V or off true differential mode
Sensitivity ²	< 50 mV pp
Intrinsic transition time ³	25 ps typical 20% to 80%, single ended
Decision threshold range	-2 V to +3 V in 1 mV steps
Maximum levels	-2.2 V to +3.2 V
Phase margin ⁴	1 UI - 12 ps typical
Clock-to-data sampling delay	± 0.75 ns in 100 fs steps
Interface	Single-ended: 50 Ω nominal, differential: 100 Ω nominal
Connector	2.4 mm female

1. Clock/data sampling delay range selectable 2 V operating voltage window, which is in the range between -2.0 V to +3.0 V. The data signals, termination voltage and decision threshold have to be within this voltage window.
2. At 10 Gb/s, BER 10⁻¹², PRBS 2³¹-1. For input levels < 100 mV manual threshold value adjustments may be required.
3. At cable input, at ECL levels.
4. Based on the internal clock.



Figure 25. Front panel connectors for error detection

Error Detector Specifications (continued)

Clock inputs (CLK IN)

The error detector requires an external clock signal to sample data or it can recover the clock from the data signal using the built-in clock data recovery (CDR).

Table 21. Specification for the clock input

Frequency range	150 MHz to 12.5 GHz (Option C13); 150 MHz to 7 GHz (Option C07)
Amplitude	100 mV to 1.2 V
Sampling	Positive or negative clock edge
Interface	AC coupled, 50 Ω nominal
Connector	SMA female

Clock data recovery

The error detector can recover the clock from the incoming data stream with the built-in clock data recovery (CDR). The recovered clock signal is available at the aux output.

Table 22. Specifications for the clock data recovery (Options C07, C13)

Input data rate	1 Gb/s to 12.5 Gb/s ¹ (Option C13) 1 Gb/s to 7 Gb/s (Option C07)
CDR clock output jitter	0.01 UI rms (RJ) typical ²
Interface	AC coupled, 50 Ω nominal
Connector	SMA female

1. With bit recovery mode (Option A01) enabled the max data rate is 11.5 Gb/s. When using SER/FER analysis (Option A02), the max. data rate is 11.5 Gb/s. Over-programming up to 12.5 Gb/s is possible, but SER/FER results are not guaranteed.
2. When measured with PRBS 2²³-1

Table 23. Specifications for tunable loop bandwidth

Tunable loop bandwidth	500 kHz to 12 MHz for data rates 1.46 Gb/s to 12.5 Gb/s 100 kHz to 4 MHz for data rates 1 Gb/s to 1.46 Gb/s
Loop bandwidth accuracy	10% typical (at transition density 50%)
Transition density compensation	25% to 100%. The CDR can automatically detect the transition density of the incoming data pattern and compensates the loop bandwidth accordingly.
Tracking range (SSC)	+0.05% to -0.55% (5500 ppm) deviation of data rate. User can disable/enable SSC tracking. Loop bandwidth > 1 MHz and medium or max peaking enabled
Jitter peaking	Three customer selectable values between 0 and 3 dB; see frequency response in Figure 27
Fine adjust	Manual adjustment -1.0 to + 1.0 of CDR settings to minimize CDR output jitter
Compliant CDR settings	PCIe, SATA, FC, FB-DIMM, CEI, GE, 10 GbE, XAUI, XFP/XFI, SONET OC-48/192 (see Table 23). User can add own CDR settings
Relax time	< 1 sec typical

Error Detector Specifications (continued)

Table 24. Compliance settings for CDR

Standard	Revision	Data rate (Gb/s)	JTF loop bandwidth (MHz)	Jitter peaking (dB)	SSC possible
PCIe	1.0	2.5	1.5	0	
	1.1	2.5	5	1	
	2.0	5.0	8	0.9	Yes
	3.0	8.0	10	<i>TBD</i>	
SATA	I	1.5	0.9, 3.0	1.3	
	II	3.0	1.8, 6.0	1.7, 1.8	Yes
	III	6.0	<i>TBD</i>	<i>TBD</i>	
FB-DIMM	1	3.2, 4.0, 4.8	11 ¹	0.9	Yes
	2	4.8, 6.4, 8.0, 9.6			
Fibre Channel	1	1.063	0.638		
	2	2.125	1.275		
	4	4.25	2.55	0	No
	8	8.5	2.55		
	10	10.518	4.0		
CEI	6.0 ²	6.0	4.0 (fbaud/1667)	0	No
	11.0	11.0	8.0 (fbaud/1667)	0.1	No
1 GbE		1.25	4	0	No
10 GbE		10.312	4	0	No
10 GbE	XAUI	3.125	1.875	0	No
SONET/SDH	OC-48/STM-16	9.953	4	0	No
	OC-192/STM-64				
XFP/XFI		9.95 ³	RX: 8.0	0.1	No
			TX: 4.0	0	

1. The standard allows 11 MHz to 22 MHz.
2. CEI standard allows data rates of 4.976 to 6.375 Gb/s and 9.95 to 11.1 Gb/s.
3. XFP/XFI standard allows data rates of 9.95 to 11.2 Gb/s.

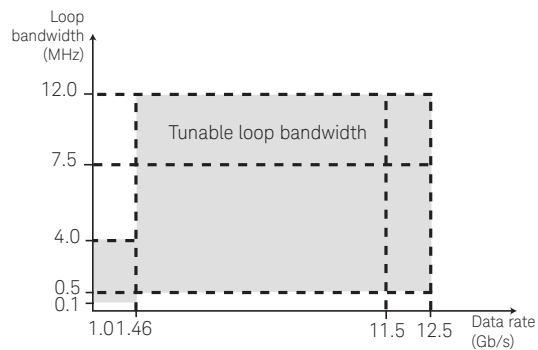

Figure 26. CDR loop bandwidth

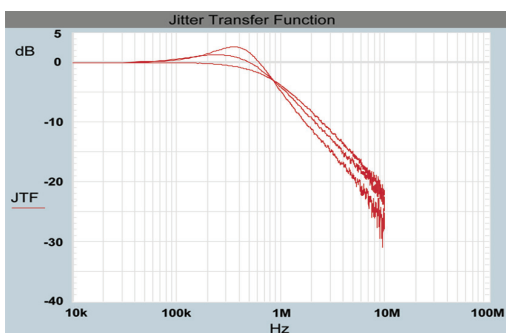

Figure 27. Three selectable frequency response settings. The example shows JTF loop bandwidth of 900 kHz and 0 dB, 1.2 dB, 2.8 dB peaking

Error Detector Specifications (continued)

J-BERT measurements

- BER results
- Symbol error ratio (SER) and calculated BER (Option A02)
- Frame error rate (FER) analysis (Option A02)
- BER results with filtering of 8b/10b coded filler symbols or 128b/130b coded SKPOS symbols (Option A02)
 - Accumulated BER results
 - Accumulated errored 0's and 1's
 - G.821
 - Error-free intervals
 - Accumulated parameters
 - Burst results
- Eye diagram results
 - 1-/0- level
 - Eye height/amplitude/width
 - Jitter p-p and rms
 - Cross-over voltage
 - Signal to noise ratio
 - Duty cycle distortion
 - Extinction ratio
- Measurement suite
 - BERT scan with RJ/DJ separation
 - Spectral jitter decomposition
 - Eye contour
 - Quick eye diagram and BER contour
 - Fast eye mask
 - Output level and Q factor
 - Error location capture
 - Fast total jitter
- Pattern capture

Trigger output (TRIG OUT)

Pattern trigger mode

This provides a trigger synchronized with the selected error detector reference pattern. In pattern mode the pulse is synchronized to repetitions of the output pattern. It generates 1 pulse for every 4th PRBS pattern.

Divided clock mode

In divided clock mode, the trigger is a square wave

Table 25. Specifications for trigger output

Clock divider	4, 8, 16 up to 11 Gb/s 32, 40, 64, 128 up to 12.5 Gb/s
Levels	High: +0.5 V typical Low: - 0.5 V typical
Minimum pulse width	Pattern length x clock period/2 e.g. 10 Gb/s with 1000 bits = 50 ns
Interface	DC coupled, 50 Ω nominal
Connector	SMA female

Error Detector Specifications (continued)

Error output (ERR OUT)

This provides a signal to indicate received errors. The output is the logical 'OR' of errors in a 128 bit segment of the data.

Table 26. Specifications for error output

Interface format	RZ, active high
Levels	High: 1 V typical Low: 0 V typical
Pulse width	128 clock periods
Interface	DC coupled, 50 Ω nominal
Connector	SMA female

Auxiliary output (AUX OUT)

This output can be used to provide either clock or data signals:

Clock: clock signals from the input or the recovered clock signals in CDR mode.

Data: weighted and sampled data.

Table 27. Specifications for the auxiliary output

Amplitude	600 mV typical
Interface	AC coupled, 50 Ω nominal
Connector	SMA female

Gating input (GATE IN)

If a logical high is applied to the gating input the analyzer will ignore the incoming bits during a BER measurement. The ignored bit sequence is a multiple of 512 bits. For measuring data in bursts of bits, rather than a continuous stream of bits, a special operating mode is used. This is the burst sync mode. In this case, the signal at the gating input controls the synchronization and the error counting for each burst.

This is an important feature for recirculation loop measurements. If clock data recovery (CDR) is used to recover the clock from the burst data, the CDR takes 2 μ s from the start of the burst data to settle. The number of bits needed to synchronize itself during a burst depends on whether the pattern consists of hardware based PRBS data or memory based data. To run properly in burst mode the system needs a backlash of data after the gating input returns to high. During each burst, the gating input has to remain passive.

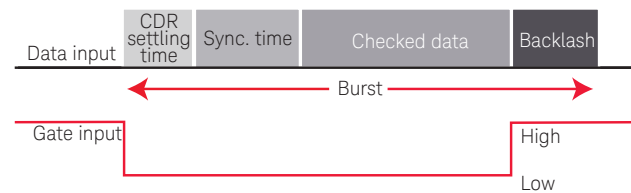

Figure 28. Burst mode allows recirculation loop testing

Error Detector Specifications (continued)

Table 28. Specifications for gating input

Burst synchronization time	1536 bits for PRBS 15 kbit for pattern
Backlash	1536 bits in non-CDR mode 1.5 μ s in CDR-mode
Gate passive time	2560 bits in non-CDR mode 2560 bits or 1.5 μ s whichever is longer, in CDR mode
Interface levels	TTL levels
Pulse width	256 clock periods
Connector	SMA female

Pattern capture

The error detector can capture up to 32 MB data bits from the device under test. The captured data bits are displayed in the pattern editor in hex or binary format. The data bits can be used as expected data for BER testing or can be saved for post processing.

SER/BER Analysis (Option A02)

The symbol error ratio (SER) analysis allows error counting of coded, packetized and retimed data streams. SATA and USB3 are popular examples of serial bus standards using retimed loop-back mode for receiver tolerance testing. SER analysis includes the automatic handling of the running disparity of 8B/10B coded patterns, filtering of up to 4 user-definable filler symbols, filtering without any dead times up to 11.5 Gb/s (up to 12.5 Gb/s when using analyzer with external clock) display of the error ratio as SER or calculated BER. This requires SW rev. 6.6 or later. Frame error ratio (FER) analysis requires SW rev. 6.8 or later. For PCIe 3.0 the option A02 enables the error counter to ignore changes in length of 128 bit/130 bit coded Skip Ordered Sets. To use this functionality N4903B Software revision 7.40 or higher is required.

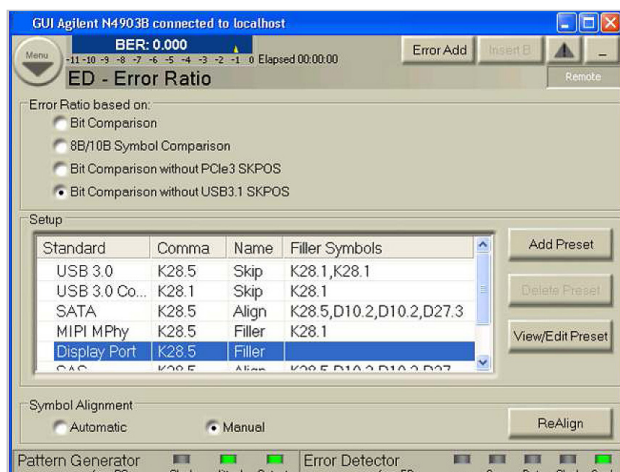

Figure 29. The analyzer options A02 and A03 enable error counting of devices such as PCIe, SATA, USB3.0 and USB3.1, that use retimed and coded loopback

Error Detector Specifications (continued)

Analysis of 128b/132b coded patterns (Option A03)

The analysis of 128b/132b coded patterns enables receiver testing of USB 3.1 ports. The BERT error detector ignores the 128b/132b coded Skip Ordered Sets during error counting. It is able to handle the variable length of these SKP OS. The max. bit rate for this mode is 10.35 Gb/s. To use option A03 functionality, the N4903B software revision 7.60 or later is required.

Mainframe Characteristics

Table 29. General mainframe characteristics

Operating temperature	5 to 40 °C (-23 to +104 °F)
Storage temperature	-40 to +70 °C (-65 to +158 °F)
Operating humidity	95% relative humidity, non-condensing
Storage humidity	50% relative humidity
Power requirements	100 to 240 V, ± 10%, 47 to 63 Hz, 450 VA
Physical dimensions	Width: 424.5 mm (16.75 in) Height: 221.5 mm (8.7 in) without feet Depth: 580.0 mm (22.9 in)
Weight (net)	26.3 kg (58.0 lb)
Weight (shipping, max)	36.3 kg (80.0 lb)



Figure 30. Rear panel view

Display

8" color LCD touch screen

Data entry

- Color touch screen display, numeric keypad with up/down arrows, dial-knob control or external key board and mouse via USB interface
- Pattern export/import

Hard disk

For local storage of user patterns and data. An external disk is also available for using over the USB interface.

Remote control interfaces

Connectivity: GPIB (IEEE 488), LAN, USB 2.0.

Language: SCPI, IVI.COM. SCPI commands can be exported via copy/paste from the utility menu/output window.

Built-in web server: provides remote GUI access and control of J-BERT via a standard Java enabled web browser on your computer.

IO libraries

Keysights IO libraries suite ships with the N4903B to help quickly establish an error-free connection between your PC and instruments regardless of the vendor.

Mainframe Characteristics (continued)

Other interfaces

Parallel printer port, 2 x LAN, VGA output, 4 x USB 2.0, 1 x USB 1.1 (front).

Operating system

Microsoft Windows XP for Embedded Systems

For S/N below MY49101000: Microsoft Windows XP Professional

Regulatory standards

Safety: IEC 61010-1:2001 EN 61010-1:2001 CAN/CSA-C22.2 No.61010-1-04

UL 61010-1:2004

EMC: EN 61326:1997 + A1:1998 + A2:2001

IEC 61326:1997 + A1:1998 + A2:2000

Quality management: ISO 9004, ISO 14001

Specification assumptions

The specifications in this document describe the instrument's warranted performance.

Non-warranted values are described as typical.

All specifications are valid in a range from 5 °C to 40 °C ambient temperature after a warm-up phase of 30 minutes.

If not otherwise stated, all unused inputs and outputs need to be terminated with 50 Ω to ground.

All specifications, if not otherwise stated, are valid using the recommended cable set N4910A (2.4 mm, 24" matched pair).

Ordering Instructions

J-BERT N4903B high-performance serial BERT

Includes six 50-Ω SMA terminations, ten adapters 3.5 mm female to 2.4 mm male, ESD protection kit, commercial calibration report and certificate (“UK6”), getting started guide, USB cable, keyboard, mouse, and Keysight I/O library.

Table 30. Option information

J-BERT Options	Description	BERT with built-in and tunable CDR N4903B	Pattern Generator N4903B
Data rate	150 Mb/s to 12.5 Gb/s 150 Mb/s to 7 Gb/s Extended data rate for pattern generator up to 14.2 Gb/s	N4903B-C13 N4903B-C07	N4903B-G13 N4903B-G07
Generator capabilities	PRBS and pattern on aux data output Half-rate clock with variable duty cycle		N4903B-002 N4903B-003
Jitter tolerance options	RJ, sRJ, PJ1, PJ2, SJ, BUJ injection SSC, rSSC generation Interference channel (includes short cable kit N4915A-008) Jitter tolerance compliance suite		N4903B-J10 N4903B-J11 ¹ N4903B-J20 ¹ N4903B-J12 ¹
Analyzer capabilities	SER/FER analysis Bit recovery mode	N4903B-A02 N4903B-A01	–
Upgrade from N4903B	Upgrade from N4903A version (factory, S/N will change)		N4903B-UAB ²
Upgrade options for N4903B	Description	BERT with built-in and tunable CDR N4903BU	Pattern Generator N4903BU
Data rate	To 12.5 Gb/s (N4903B-C13/ N4903B-G13) from 7 Gb/s (N4903B-C07/ N4903B-G07) To 14.2 Gb/s data rate extension (factory)		N4903BU-U13 N4903BU-D14 ³
Generator capabilities	To PRBS and pattern on aux data output To half-rate clock with variable duty cycle		N4903BU-U02 N4903BU-U03
Jitter tolerance options	To RJ,sRJ,PJ1,PJ2,SJ,BUJ injection To SSC, rSSC generation To interference channel To jitter tolerance compliance suite		N4903BU -U10 N4903BU-U11 N4903BU-J20 N4903BU-U12
Analyzer capabilities	To SER/FER analysis To bit recovery mode To analysis of 128B/132B coded pattern To BERT from pattern generator (factory)	N4903BU-UA2 N4903BU-UA1 N4903BU-UA3 –	– – – N4903BU-UED

1. Only available with Option J10

2. Requires N4903A-J10/-U10 or N4903B-J10 and N4903A-CTR/-UTR or N4903B-UTR; upgrade does not include N4915A-008 short cable kit for ISI ports

3. Requires Option -G13, -C13, or -U13

Table 31. Productivity services

Productivity	Productivity assistance, remote or on-site	R1380-N49xx PS-S20 and PS-S10
--------------	--	-------------------------------

Accessories

Table 32. Recommended accessories

Recommended accessories	Description	Model number
Cables, adapters		
	Power divider 2.4 mm	11636C
	Short matched cable pair for connecting power divider to N4903B or N4876A	N4915A-012
	Matched cable kit for connecting N4903B to N4877A CDR	N4915A-015
	Pick-off kit for connecting N4903B with N4877A	N4915A-017
	2.4 mm matched pair cable	N4910A
	Adapter 3.5 mm (f) to 2.4 mm(m)	N4911A-002
	50 Ω termination, 2.4 mm	N4912A
	Short cable kit, 2.4 mm(m) to 2.4 mm(m) for ISI ports	N4915A-008
	Clock cable, 2.4 mm to SMA	N4915A-009
	Four SMA-to-SMA cables	15442A
	Matched cable pair for connecting N4903B with N4916B (1 x 2.4 mm to SMA for data, 1x SMA-to-SMA for clock, 167 ps longer)	N4915A-010
	Matched cable kit for connecting N4903B with N4876A (2 x 2.4 mm to SMA, 1x SMA-to-SMA)	N4915A-011
	Serial bus switch 6.5 Gb/s	N4915A-005
	DisplayPort ISI generator	N4915A-006
	SATA ISI channel	N4915-60001
	PCIe 3.0 calibration channels	N4915A-014
Signal stress conditioning		
	4-tap de-emphasis signal converter with optional clock multiplier	N4916B-STD
	Optical receiver stress test	N4917A
	47 ps transition time converter	N4915A-001
	Filter set for PCIe 2.0 testing with 81150A	15431A
Data rate extension		
	28 Gb/s multiplexer 2:1	N4876A-001
	32/17 Gb/s clock data recovery with de-multiplexer 1:2	N4877A
Software		
	Test automation software platform for RX and TX test of USB, SATA, PCIe, DP, SD UHS-II, TBT, MIPI	N5990A

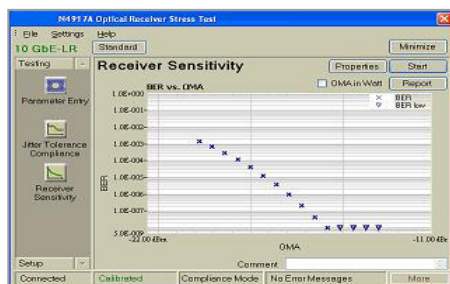

Figure 31. Optical receiver stress testing with N4917A allows calibrated stressed receiver sensitivity tests



Figure 32. 4-tap de-emphasis signal converter with optional clock multiplier N4916B



Figure 33. 28 Gb/s multiplexer 2:1 N4876A



Figure 34. 32Gb/s clock data recovery with de-multiplexer 2:1 N4877A. Can be used with optical pick-off N1075A

Related Literature

Title	Publication number
Application Notes:	
<i>How to pass Receiver Test according PCI Express 3.0 CEM Specification</i>	5990-7659EN
<i>Accurate Calibration of PCIe 3.0® Receiver Stress Signals</i>	5990-6599EN
<i>Error Detection up to 28.4 Gb/s using under-sampling techniques with J-BERT N4903B</i>	5990-6239EN
<i>Keysight Method of Implementation (MOI) for DisplayPort Sink Compliance Test</i>	5989-9147EN
<i>Calibrating Optical Stress Signals for Characterizing 10 Gb/s Optical Transceiver</i>	5989-8393EN
<i>Calibrated Jitter, Jitter Tolerance Test and Jitter Laboratory with the J-BERT N4903A</i>	5989-4967EN
<i>SATA Receiver Test with N4915A-005 Serial Bus Switch</i>	5989-7532EN
<i>PCIe Revision 2 Receiver Jitter Tolerance Testing with J-BERT N4903B</i>	5989-4087EN
<i>Bit Recovery Mode for Characterizing Idle and Framed Data Traffic</i>	5989-3796EN
<i>Forward Clocking - Receiver Jitter Tolerance Test with J-BERT N4903B</i>	5990-3575EN
<i>PCIe2.0 Receiver Testing</i>	5990-3233EN
<i>Fast Total Jitter Solution</i>	5989-3151EN
Data Sheets:	
<i>N4876A 28 Gb/s Multiplexer 2:1 Data Sheet</i>	5990-5247EN
<i>N4877A Clock Data Recovery with Demultiplexer and N1075A Optical Pick-off</i>	5990-9949EN
<i>N4880A Reference Clock Multiplier</i>	5990-9592EN
<i>N4906B Serial BERT 3 and 12.5 Gb/s</i>	5989-2406EN
<i>N4915A-006 DisplayPort ISI Generator</i>	5989-8688EN
<i>N4915A-014 PCI Express 3.0 Calibration Channels t</i>	5990-7659EN
<i>N4916B 4-Tap De-Emphasis Signal Converter</i>	5990-4630EN
<i>N4917A Optical Receiver Stress Test</i>	5989-6315EN
<i>N4960A Serial BERT 32 and 17 Gb/s</i>	5991-0712EN
<i>N5990A Test Automation Software for PCIe, SATA, USB, DP, MIPI, UHS-II, TBT, HDMI</i>	5989-5483EN
<i>Infiniium DCA-X 86100D Wide-Bandwidth Oscilloscope Mainframe and Modules</i>	5990-5824EN
<i>Infiniium 90000X-Series Oscilloscopes 16-32 GHz True Analog Bandwidth</i>	5990-5271EN
<i>Infiniium DSO90000 Series High-Performance Oscilloscopes</i>	5989-7819EN
<i>ParBERT 81250 Product Overview</i>	5968-9188E
<i>N4915A-005 Serial Bus Switch</i>	5989-7328EN
<i>N4915A-014 PCI Express 3.0® Calibration Channels</i>	5990-7659EN
Brochures, posters:	
<i>Mastering Jitter in Serial Gigabit Designs, Brochure</i>	5989-4823EN

Learn more at: www.keysight.com

For more information on Keysight Technologies' products, applications or services, please contact your local Keysight office. The complete list is available at: www.keysight.com/find/contactus

