

Infiniium 90000 Q-Series Oscilloscopes

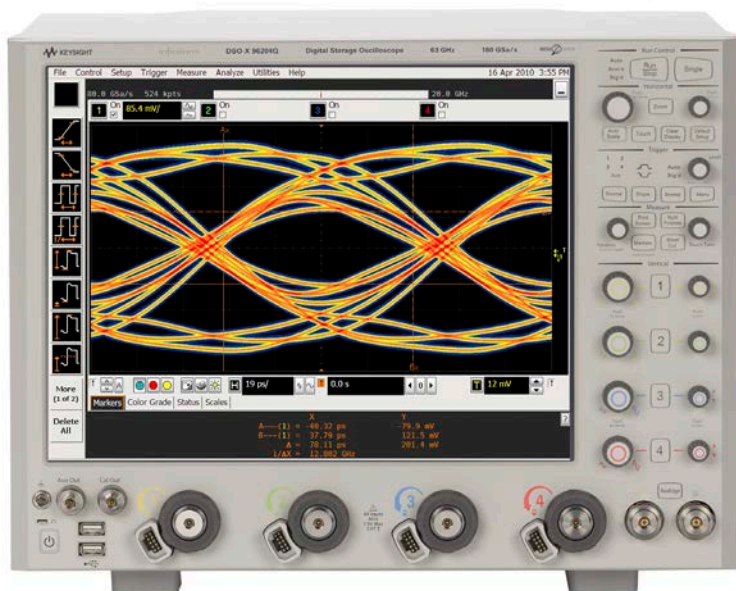

Introduction

Achieve your real edge

- 63 GHz of real-time oscilloscope bandwidth
- The industry's highest 4-channel bandwidth in a single frame (33 GHz)
- The industry's lowest noise and jitter measurement floor
- The industry's deepest memory

At the extremes of electrical and optical measurements, the right oscilloscope will help you explore the “what” and understand the “why.” That’s the idea behind the Keysight Technologies, Inc. Q-Series oscilloscopes, our latest step forward in the application of the Keysight microwave expertise to real-time oscilloscopes. With industry-leading bandwidths, the Q-Series lets you see your fastest signals as they really are. Equip your lab with Q-Series scopes—and achieve your real edge.



The 90000 Q-Series captures rise times as fast as 5ps (20/80)

	Bandwidth		Sample rate		Memory depth	
	2 channel	4 channel	2 channel	4 channel	Standard	Maximum
DSAX96204Q	63 GHz	33 GHz	160 GSa/s	80 GSa/s	50 M	2 Gpts
DSOX96204Q					20 M	2 Gpts
DSAX95004Q	50 GHz	33 GHz	160 GSa/s	80 GSa/s	50 M	2 Gpts
DSOX95004Q					20 M	2 Gpts
DSAX93304Q	33 GHz	33 GHz	160 GSa/s	80 GSa/s	50 M	2 Gpts
DSOX93304Q					20 M	2 Gpts
DSAX92504Q	25 GHz	25 GHz	80 GSa/s	80 GSa/s	50 M	2 Gpts
DSOX92504Q					20 M	2 Gpts
DSAX92004Q	20 GHz	20 GHz	80 GSa/s	80 GSa/s	50 M	2 Gpts
DSOX92004Q					20 M	2 Gpts

Advanced IC Design and Technology Help you Solve your Biggest Problems

At the extremes of electrical and optical measurements ...

You need to make rise time measurements without being limited by scope bandwidth:

The Q-Series is Keysight's first oscilloscope to use RealEdge technology, which allows for an industry-leading 63 GHz of bandwidth on two channels. RealEdge technology uses custom chips to seamlessly increase the bandwidth of Q-Series oscilloscopes.

You need to see your signal and not oscilloscope noise:

The Q-Series leverages technology from the award-winning Infiniium 90000 X-Series oscilloscope, which provides leading signal integrity specifications. The Q-Series takes advantage of leading-edge indium phosphide chip technology and custom thin film packaging technology, which ultimately leads to the lowest-noise real-time oscilloscope in the world. With industry-leading bandwidths, Q-Series scopes let you see your fastest signals as they really are.

You need to see your signal and not your measurement system:

Using Keysight's proprietary indium phosphide technology the N2806A calibration pulse generator creates a signal edge that is an incredible 5 ps (20/80), which the Q-Series is capable of measuring.

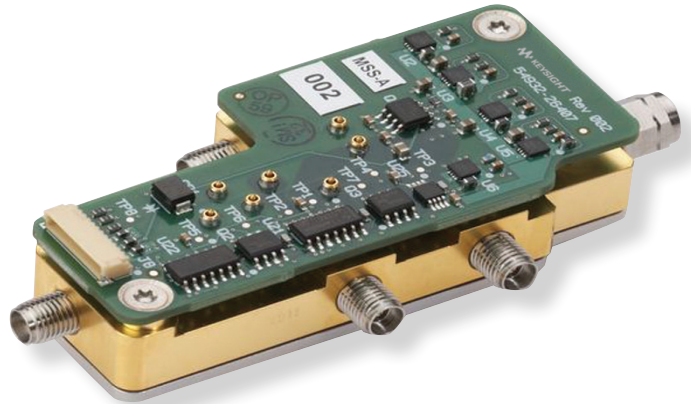

Infiniium's new RealEdge technology blocks enable 63-GHz real-time bandwidth

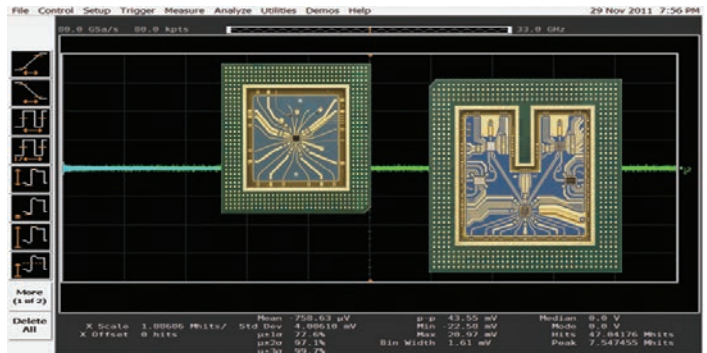

Infiniium's custom multichip modules feature indium phosphide chips and Keysight proprietary packaging technology, enabling high bandwidth and low noise

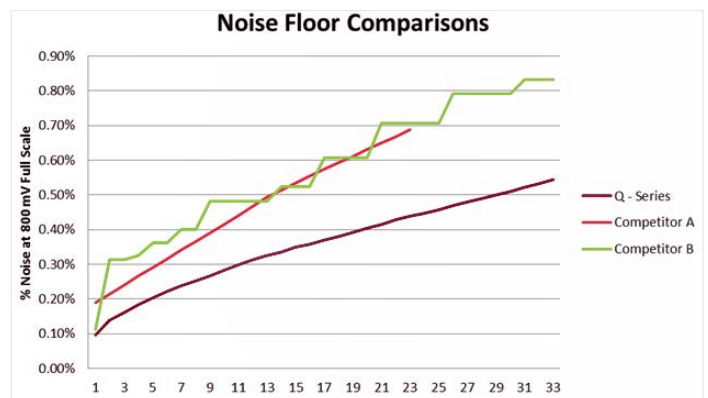

The 90000 Q-Series features the industry's lowest noise floor

Digital: The Scope

At the extremes of electrical and optical measurements, the right oscilloscope will help you explore the “what” and understand the “why” in

With 63 GHz of bandwidth to capture rise times as fast as 5 ps and data rates as fast as 120 Gbit/s the 90000 Q-Series is the world’s fastest real time oscilloscope. Its four channels at 33 GHz make it ideal for 28 and 32 Gbit/s SERDES designs. In addition to providing leading edge bandwidth, the Q-Series helps you to find your real edge, by featuring the industry’s lowest noise and jitter measurement floor, which means less scope noise in your measurements and a truer depiction of your signal.

Q-Series scopes help you understand the “why” by providing insight with:

1. Analysis on memory depths up to 2 Gpts of data
2. Clock recovery on data rates as fast as 120 Gb/s, perfect for 28/32-Gb/s SERDES
3. Two unique jitter separation algorithms, including bounded uncorrelated jitter breakdown
4. The only waveform transformation software to properly model difficult solutions such as reflection
5. Full offline analysis

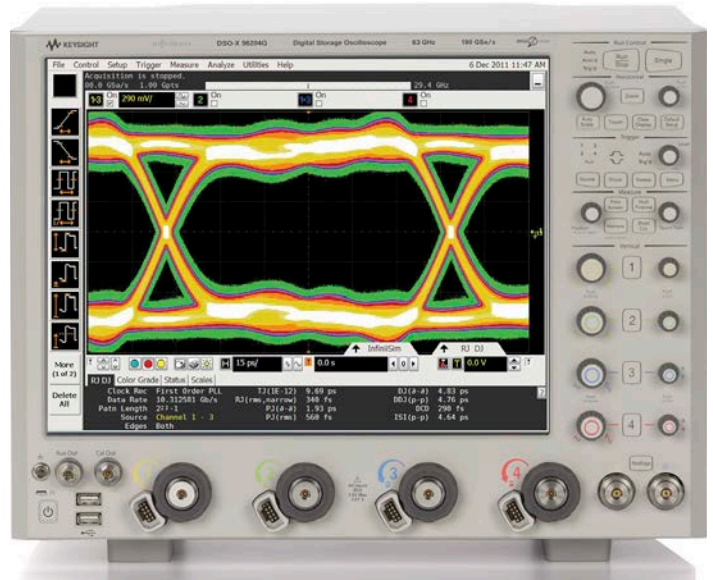

Using the 90000 Q-Series, you can capture sub 500 fs random jitter measurements on your devices

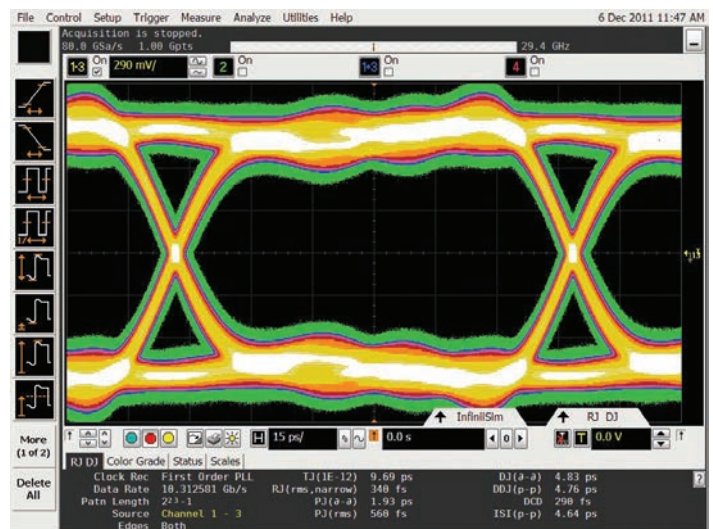

With its flat frequency response and low noise, the 90000 Q-Series is able to accurately measure jitter components such as ISI

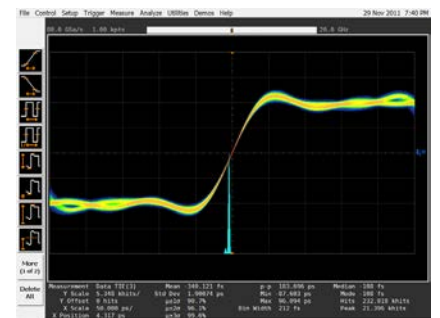
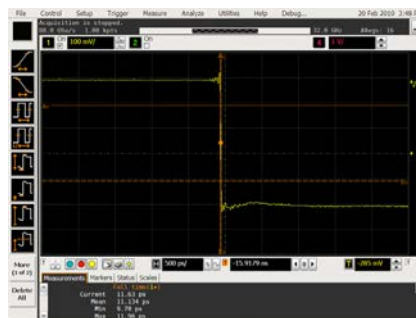

Frequency Domain: The Spectrum Analyzer

At the extremes of technology measurements, you need more than just an oscilloscope. You need ...

To easily compute both magnitude and phase

Infiniium Q-Series oscilloscopes include a fast fourier transform (FFT) for frequency domain (spectrum) analysis. This feature is especially valuable if you have limited access or no access to a spectrum analyzer, yet you need occasional frequency domain analysis capability. The integrated FFT offers an alternative to a dedicated spectrum analyzer. Use the Q-Series FFT to compute both magnitude and phase and take advantage of several useful features to assist in spectral analysis. Q-Series scopes include controls to adjust memory depth, sampling rate, vertical scale and horizontal scale of the FFT. The FFT can control span and resolution bandwidth. Automatic measurements and markers measure spectral peak frequencies and magnitudes as well as deltas between peaks. Infiniium Q-Series oscilloscopes include peak search capability to ensure quick capture of peak frequencies. The Q-Series is fully compatible with Keysight's vector signal analysis (VSA) and W2650A oscilloscope signal analysis (OSA) software, to provide the deepest analysis capability.

Software features and benefits

- Multiple FFT windows including Hanning, rectangular, Blackman-Harris, flattop, and Hamming
- Peak search and navigation for fast analysis
- Constellation diagram analysis available on the VSA software
- Segmented memory for pulsed and modulation domain signal analysis of radar and EW waveforms (OSA)
- Volts vs. time and power (dBm) vs. time (OSA software)
- CW and modulation measurements

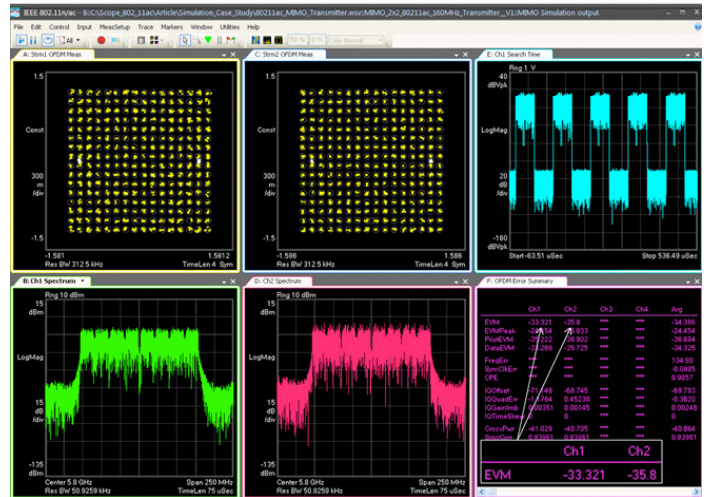

Keysight's 89601B Vector signal analysis software turns the 90000 Q-Series into spectrum analyzer



Keysight's InfiniiView software provides full off line capability including FFTs

Complex Modulation: Optical Modulation Analyzer

At the extremes of electrical and optical measurements, the right oscilloscope will help you explore the “what” and understand the “why” in ...

Q-Series oscilloscopes are also available in combination with the N4391A optical modulation analyzer as a fully specified turn-key instrument. This compact solution offers the highest bandwidth available on the market and is the most advanced test solution for advanced research on 400-G and terabit transmission. Even for the lower 20-GHz bandwidth range, this compact and easy-to-use solution is a reference system for 100-G transmission required by R&D labs working at 100 G and beyond. By providing four channels of 33 GHz bandwidth, the Q-Series saves you the expense of a second instrument to analyze dual polarization.

If you prefer to operate with your own optical receivers but want to benefit from the enormous analysis capability, you can get the N4391A's analysis software as a standalone package.

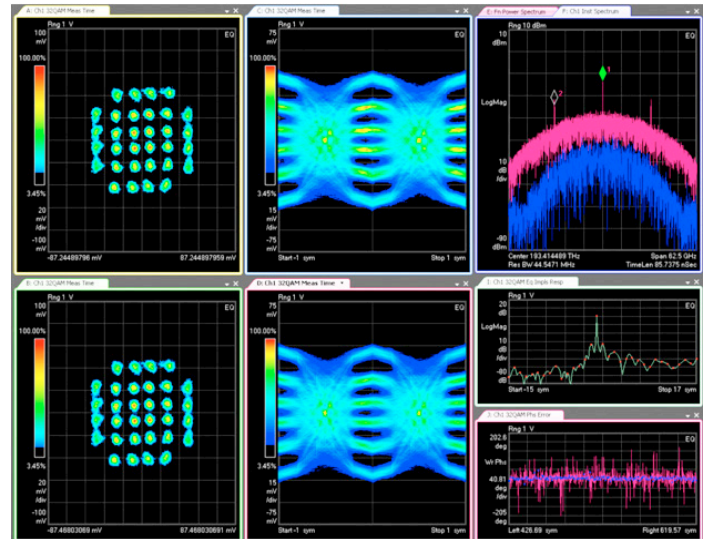

The N4391A offers a powerful toolset to debug the most challenging errors, with tools proven by thousands of RF engineers

Features and benefits

- Up to 33 GHz true analog bandwidth on four channels
- 40 GHz support to the N4391A in near future
- Up to 120 Gbaud symbol rate analysis
- Four times better EVM noise floor than typical QPSK transmitter
- Compact four channels in turn-key solution
- 4 x 80-Gs real-time sampling for optimal phase tracking
- Well-defined interface to include your own MATLAB algorithms
- Customer-configurable APSK and OFDM decoders

Network Analysis: Time-Domain Transmissometry (TDT)

At the extremes of technology measurements, you need more than just an oscilloscope. You need...

You need to be able to maximize your margins by removing the effects of cables and fixtures.

Q-Series oscilloscopes offer award-winning PrecisionProbe Advanced technology. You no longer need to ignore cable loss because you are short on time or budget. Using PrecisionProbe Advanced technology, you can characterize cables as fast as 63 GHz and remove the loss that they create. PrecisionProbe Advanced technology give you one of the world's fastest edges at less than 5 ps and uses this edge to perform a TDT on your cable. Based on the loss of your cable, PrecisionProbe Advanced then compensates your measurement system, gaining back valuable margin typically lost in cables. As bandwidths continue to increase and cable loss becomes more and more of a problem, the Q-Series has the technology to solve this problem.

You need to automate multiple lanes automatically and still maximize margins.

The Q-Series features Keysight's compliance applications which provide full automation of any switch connected to your system. The software is fully compatible with PrecisionProbe Advanced compensation, which allows you to characterize every input using only your Q-Series oscilloscope and then seamlessly automate every measurement in your compliance application. Save valuable time and resources in such technologies as DisplayPort and PCI Express® Gen3.



PrecisionProbe software characterizes cables to 63 GHz

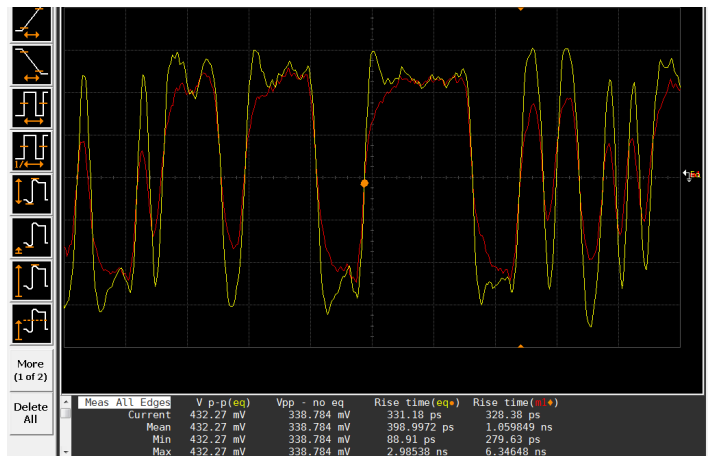

By analyzing cables you can increase your margins by removing insertion loss caused by cables

The World's Fastest Probing System for your Highest Performance Needs

The InfiniiMax III probing system provides the highest bandwidth and incredibly low loading to allow for a completely new level of signal fidelity and accuracy. Four different InfiniiMax III probe amplifiers ranging from 16 to 30 GHz are available for matching your probing solution to your performance and budget requirements. The InfiniiMax III probe system is unmatched by any product in the market. It uses a proprietary 200-GHz fT indium phosphide IC process with backside ground vias and novel thick-film technology to accommodate your highest-performance needs.



Industry's only upgradable probing system

Description	Probe or accessory	Bandwidth
30-GHz InfiniiMax III probe amp	N2803A	30 GHz
25-GHz InfiniiMax III probe amp	N2802A	25 GHz
20-GHz InfiniiMax III probe amp	N2801A	20 GHz
16-GHz InfiniiMax III probe amp	N2800A	16 GHz
ZIF probe head	N5439A	28 GHz
Browser (handheld) probe head	N5445A	30 GHz
Solder-In probe head	N5441A	16 GHz
PC board ZIF tip	N2838A	25 GHz
3.5/2.92/SMA probe head	N5444A	28 GHz
Performance verification fixture	N5443A	30 GHz
Solder-in head	N2836A	26 GHz
450-ohm ZIF tip kit (set of five)	N5440A	28 GHz
200-ohm ZIF tip kit (set of five)	N5447A	28 GHz
Browser tip replacement	N5476A	30 GHz
Precision BNC adaptor	N5442A	13 GHz
Sampling scope adaptor	N5477A	30 GHz
2.9-mm flexible cable	N5448A	30 GHz
High-impedance probe adaptor	N5449A	500 MHz
35-GHz flexible cable	N2812A	35 GHz



Achieve your Real Edge

Having the right amount of oscilloscope bandwidth ensures accurate measurements. If you have too much bandwidth, oscilloscope noise becomes a contributor in your measurement. With too little bandwidth, rise times are improperly depicted. Use the chart below to find the correct oscilloscope bandwidth for the devices you are measuring.

Recommended scope bandwidth

Technology	Data rate	Fastest rise time	Scope BW
Ethernet 10BASE-T	10 Mbps	30 ns	600 MHz
Ethernet 100BASE-T	100 Mbps	3 ns	600 MHz
Ethernet 1000BASE-T	250 Mbps x 4	1.2 ns	1 GHz
USB 2.0	480 Mbps	300 ps	2.5 G
USB 3.0	5 Gbps	50 ps	12 GHz
DDR1	400 MT/s	500 ps	2 GHz
DDR2	1066 MT/s	250 ps	4 GHz
DDR3	2133 MT/s	100 ps	8 GHz
DDR4	3200 MT/s	75 ps	12 GHz
GDDR5	8 Gbps	30 ps	16 GHz
SATA 3G	3 Gbps	67 ps	12 GHz
SATA 6G	6 Gbps	33 ps	16 GHz
SAS-2	6 Gbps	42 ps	16 GHz
SAS-3	12 Gbps	21 ps	30 GHz
16G FibreChannel	14.025 Gbps	24 ps	30 GHz
HDMI 1.4	3.4 Gbps	50 ps	8 GHz
DisplayPort 1.2	17.28 Gbps	50 ps	13 GHz
10G Ethernet	10 Gbps	60 ps	12 GHz
10Gbase-KR	10.3125 Gbps	24 ps	25 GHz
XAUI	3.75 Gbps	60 ps	12 GHz
MIPI M-PHY®	5.83 Gbps	17.2 ps	24 GHz
MIPI D-PHY™	1.5 Gbps	100 ps	6 GHz
PCI Express 2	5 Gbps	30 ps	12.5 GHz
PCI Express 3	8 Gbps	25 ps (est.)	16 GHz
28/32G FibreChannel	28 Gbps	18 ps	45 GHz
Thunderbolt 10G	10.3125 Gbps	22 ps	25 GHz
SFP +	10 Gbps	34 ps	16 GHz
MHL	2.25 Gbps	75 ps	8 GHz
InfiniiBand II	2.5 Gbps, 5 Gbps	75 ps	8 GHz

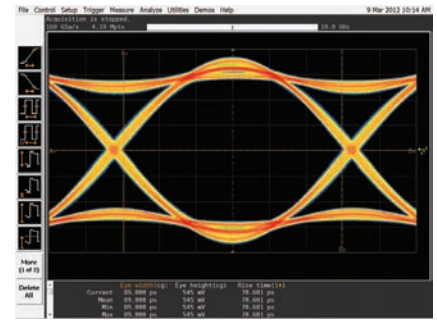

10 Gbps eye captured with 10 GHz of bandwidth

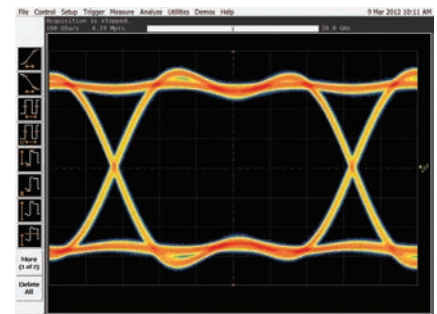

10 Gbps eye captured with 20 GHz of bandwidth

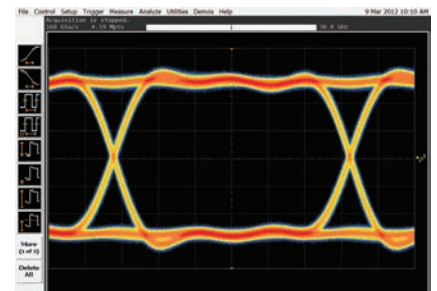

10 Gbps eye captured with 30 GHz of bandwidth

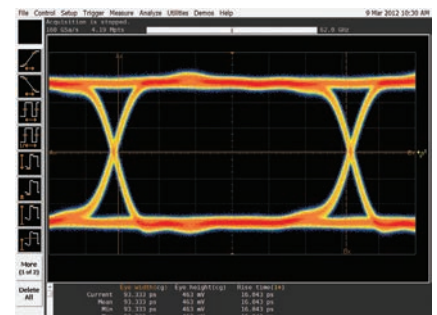

10 Gbps signal captured with 62 GHz of bandwidth, notice the faster rise time and wider eye measurements

Achieve your Real Edge (Continued)

Introducing Infiniium 90000 Q-Series oscilloscopes

33 GHz of true analog bandwidth and 80 GS/s on all four channels.

Live indicator shows when the scope is running a long operation.

See your signal more clearly with a large 15.4-inch XGA (1024 x 768) high-resolution color touch-screen display.

Identify anomalies easily with a 256-level intensity-graded or color-graded persistence display. Use variable persistence for even more display options.

Remote access through 10/100/1000 BASE-T LAN interface with Web-enabled connectivity uses ultra-responsive UltraVNC.

USB and LAN provide remote measurements. Infiniium application remote program interface (now a standard feature) allows application/compliance software automation.

Calibration edge with a rise time of less than 15 ps enables TDT calibration with PrecisionProbe. Use the Infiniium calibration source as part of PrecisionProbe Advanced to extend calibration to an unmatched 63 GHz.

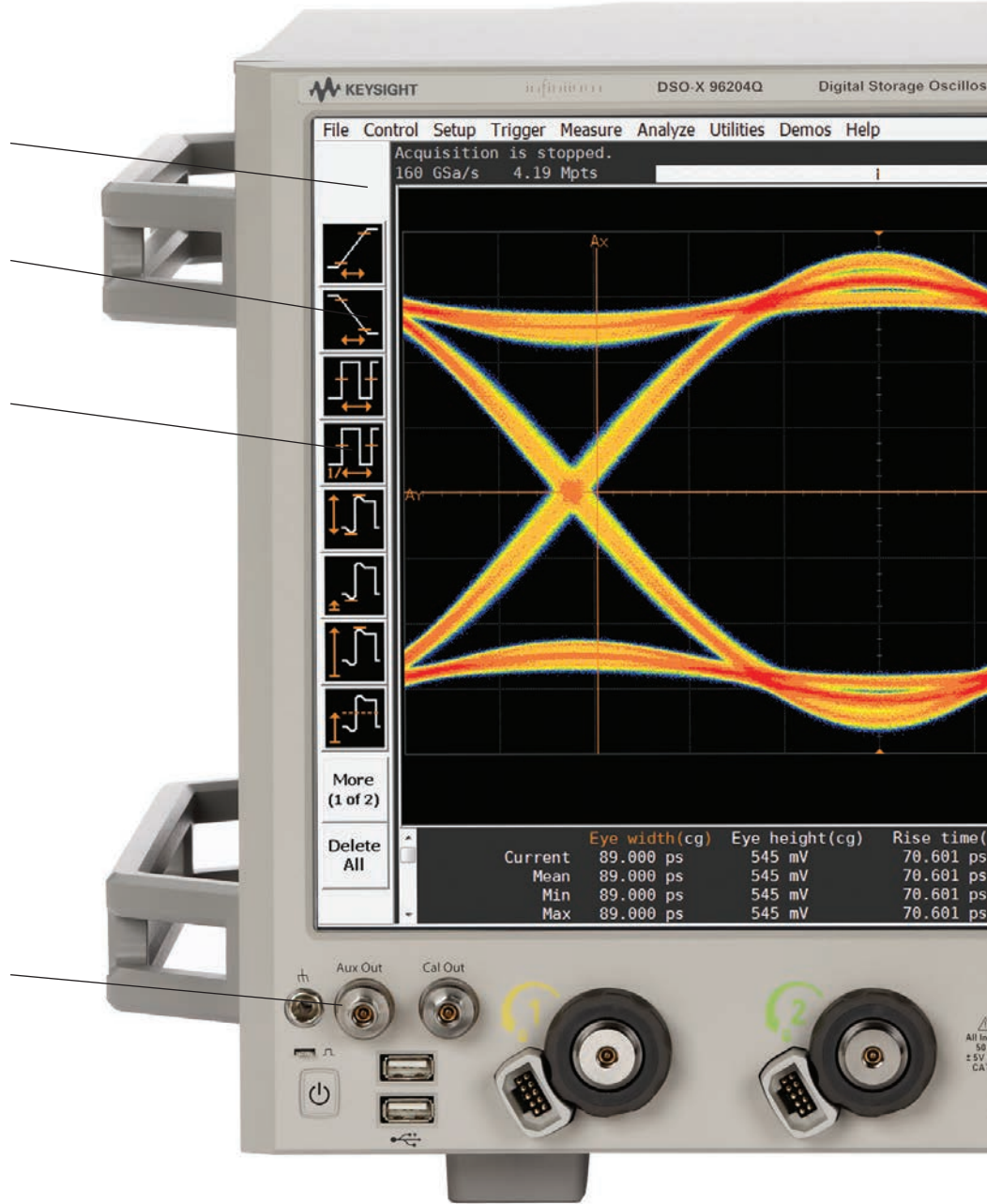

Threaded RF connectors ensure the most reliable signal integrity for high-performance instruments. The Autoprobe II interface combines the tried-and-true 3.5-mm threaded RF connector of Keysight sampling scopes with a convenient automatic torque mechanism that ensures a consistent 8 in. lbs. connection without the hassles of a torque wrench.



A new 100-MHz reference clock ties up to ten 90000 Q-Series scopes together with sub 200 fs precision. A 10-MHz clock allows tying multiple instruments together with the 90000 Q-Series.

Multipurpose knob and button allow you to customize the oscilloscope's front panel to perform the operations you use the most.

Measure section, including a toggling marker button and a dedicated marker knob, provides quick access to your marker control.

The horizontal and vertical knobs can be changed to control functions and waveform memories. Simply right click the channel control in the GUI to change these controls.

RealEdge button makes changing from 33 GHz inputs to 63 GHz inputs as easy as pushing a button.

Increase your productivity with a familiar Infiniium graphical user interface, including your favorite drag-and-drop measurement icons. Infiniium's analog-like front panel has a full set of controls color-coded to the waveforms and measurements, making your tasks simple.

The 90000 Q-Series improves upon Keysight's use of custom integrated circuits and multichip module packaging with an exclusive new technology called RealEdge. RealEdge comprises a combination of new architectures, next-generation microcircuits and thin-film components, and advanced application of Keysight's indium phosphide semiconductor process. This new technology enables high-frequency capability while maintaining the industry's lowest noise and jitter measurement floor (75 fs).

Achieve your Real Edge (Continued)

Realize your best design

Low noise and jitter

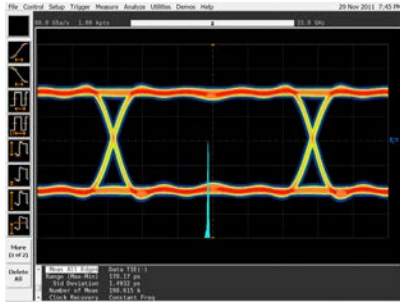

The 90000 Q-Series features the lowest noise floor and jitter measurements, allowing you to truly see your signal and get your device to market faster.

PrecisionProbe



By characterizing and compensating for loss in cables, you can gain significant margin. Keysight's PrecisionProbe software was used to gain 10% margins in this PCI Express Gen3 design.

Waveform transformation



Debugging next-generation buses such as PCI Express and Thunderbolt require advanced analysis tools. Keysight's InfiniiSim software helps you model the most difficult situations.

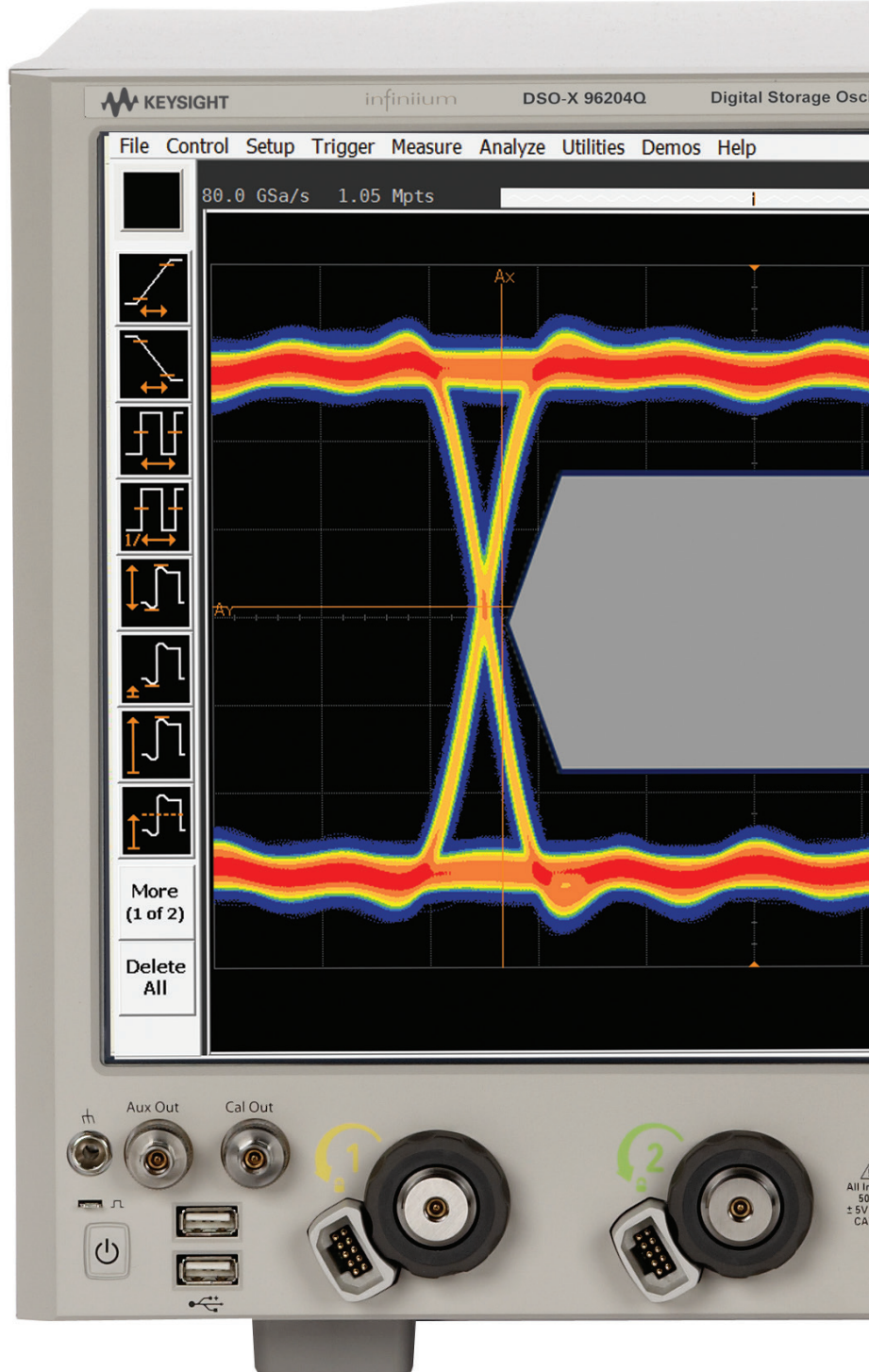

Infiniium 90000 Q-Series oscilloscopes are the world's only 4-channel, 33-GHz real-time oscilloscopes. Q-Series scopes are the only scopes that feature 30-GHz probes, making debugging your system easier and ensuring you aren't missing valuable harmonic content.

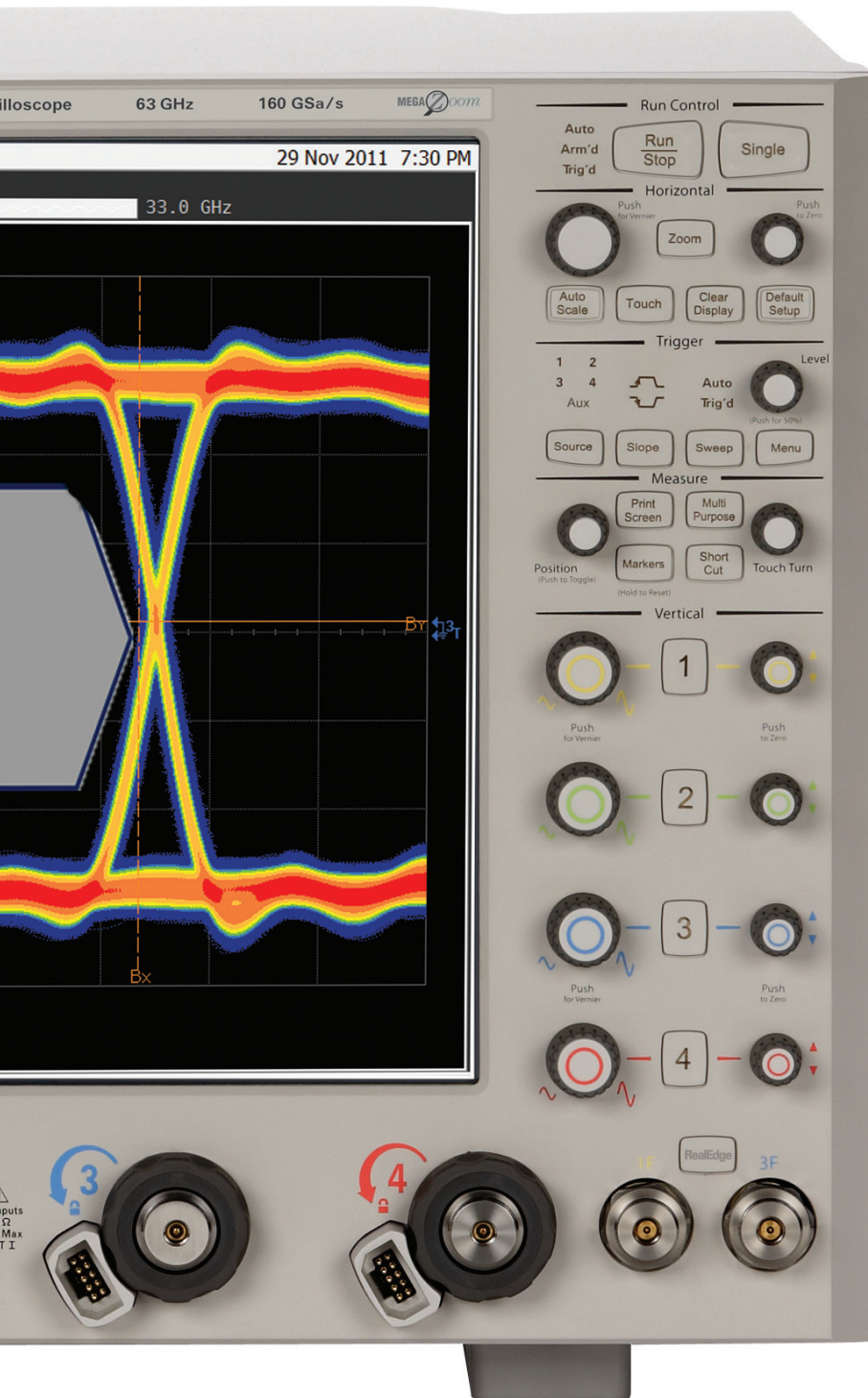

Compliance software

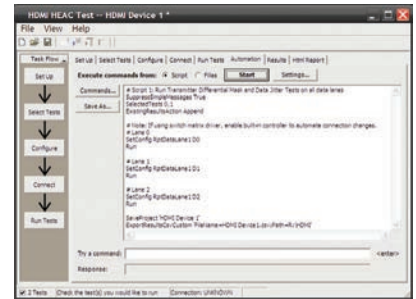

Keysight's compliance software packages are certified by experts and provide assurance when you pass in-house you will pass at your customer site as well.

Protocol analysis

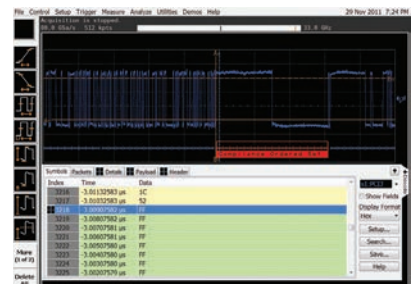

Infiniium protocol tools simplify debugging your design. Infiniium scopes offer full protocol analysis for PCI Express Gen 1, 2, and 3. The 128b/130b decoding features a lister that makes alignment between the lister and analog channels simple.

Advanced jitter and noise separation

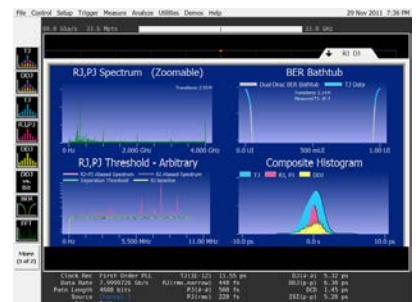

Infiniium's new noise analysis tools allow you to analyze your data bus completely.

Q-Series oscilloscopes features application-specific software that allows you to gain the insight into your design that you need. Whether you are solving tough jitter or noise problems, removing loss due to cables or probes, or simply looking at protocol, the Q-Series has the tools to help you ensure you realize your best design.

Analysis Tools: PrecisionProbe Basic and Advanced (Options 001 and 827)

Turn your 90000 Q-Series oscilloscope into a time-domain transmissometry (TDT) and quickly characterize and compensate any input into your scope.

PrecisionProbe technology turns your oscilloscope into the ultimate characterization tool. Not only can you do the normal de-embedding through InfiniiSim, PrecisionProbe allows quick characterization of your entire probe system (including cables and switches) without the need for extra equipment. PrecisionProbe takes advantage of the fast “cal output” signal on the 90000 Q-Series to characterize and compensate for loss on the measurement system.

PrecisionProbe technology:

- Properly creates custom probe transfer function = V_{Out} / V_{In}
- Properly characterizes probed system transfer function such that $V_{Out} / V_{Inc} = V_{Out} / V_{Src}$
- Removes unwanted S21 cable loss

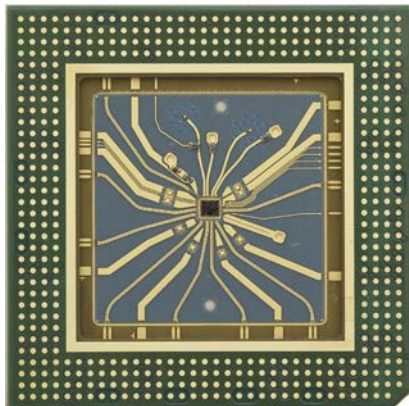

Every 90000 Q-Series oscilloscope has Keysight's custom InP fast edge

Now every probe and cable in the system can have the exact same response – probe to probe or cable to cable – without the inaccuracies that using one model can produce. Now you can properly characterize custom probes and remove unwanted responses. In addition to characterizing the cables, PrecisionProbe allows for immediate use on the same instrument. PrecisionProbe saves you time and money while increasing your measurement accuracy.

When you combine InfiniiMax probes with switches between the amplifier and the probe head, PrecisionProbe allows for full correction and automation of each probes path. Full automation is then available to allow for quick swapping of the inputs via Infiniium's compliance framework. For increased accuracy, purchase PrecisionProbe Advanced for faster edge speeds and true differential measurements.

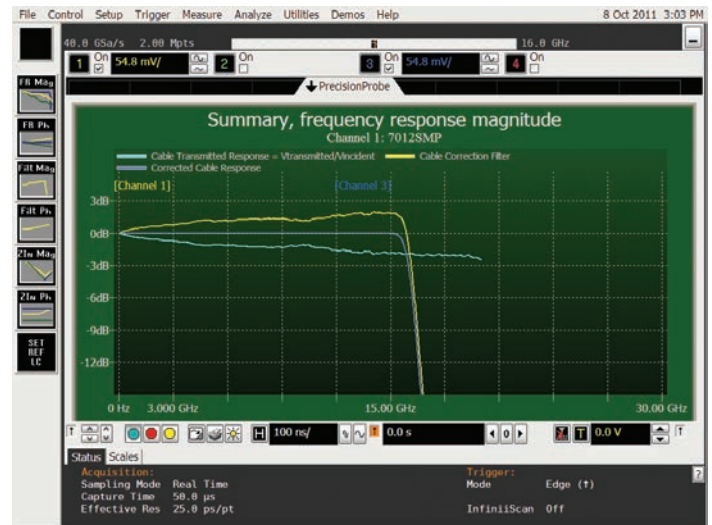

PCI Express measurement comparisons

Root complex device	Eye height (mV)	Eye height PrecisionProbe	Gain
2.5 GT/s_12 GHz	517.19	553.94	7.1%
5 GT/s_12 GHz_3.5 dB	312.22	348.19	11.5%
5 GT/s_12 GHz_6 dB	341.1	376	10.2%
5 GT/s_16 GHz_3.5 dB	306.6	348.33	13.6%
5 GT/s_16 GHz_6 dB	344.4	374.41	8.7%
8 GT/s_12 GHz_P7	96.83	103.09	6.5%
8 GT/s_12 GHz_P8	100.16	108.33	8.2%
8 GT/s_16 GHz_P7	96.92	106.01	9.4%
8 GT/s_16 GHz_P8	100.24	108.24	8.0%

By characterizing and compensating for cable loss on the cable connected to the PCI Express test fixture, the designer was able to gain between 6.5% and 13.6% margin that would have been lost otherwise.

Analysis Tools: EZJIT, EZJIT Plus, and SDA (Standard on DSA Models)

Gain insight into the causes of signal jitter to ensure high reliability of your design

With faster edge speeds and shrinking data-valid windows in today's high-speed digital designs, insight into the causes of jitter has become critical for success. Using EZJIT and EZJIT Plus jitter analysis software the Q-Series oscilloscopes help you identify and quantify jitter components that affect the reliability of your design. Time correlation of jitter to the real-time signal makes it easy to trace jitter components to their sources. Additional compliance views and a measurement setup wizard simplify and automate RJ/DJ separation for testing against industry standards. EZJIT Plus automatically detects embedded clock frequencies and repetitive data patterns on the oscilloscope inputs and calculates the level of data-dependent jitter (DDJ) that is contributed to the total jitter (TJ) PDF by each transition in the pattern, a feature not available on any other real-time oscilloscope today.

Measurement trends and jitter spectrum

EZJIT's simple tools help you quickly analyze the causes of jitter. Measurement trends allow you to see deeper views of factors affecting measurements. Jitter spectrum is a fast method to find the causes of jitter.

Two ways to separate jitter

EZJIT Plus comes with two ways to separate jitter: the industry standard dual-Dirac method and the emerging tail-fit method. Both methods allow for simple separation of RJ and DJ, but the tail-fit method provides jitter separation in the unique case of non-symmetrical histograms.

Unique RJ/DJ threshold view

EZJIT Plus also provides a unique spectral view of the jitter spectrum with the threshold drawn on the chart. The spectral view provides insight into the decision point of the separation and allows for narrow or wide, tail-fit, or Dual-Dirac.

Real-time eye and clock recovery

Serial data analysis (SDA) software provides flexible clock recovery including 1st and 2nd-order PLL and constant algorithms. With a stable clock, you can look at real-time eyes of transition and non-transition bits. Q-Series scopes with SDA software also provide a new unique view of bits preceding an eye.

8b/10b protocol

Serial data analysis software comes complete with 8b/10b protocol and decoding. The analysis allows you to search and trigger on the event you are looking for.



Use EZJIT software to extract spread spectrum clocks

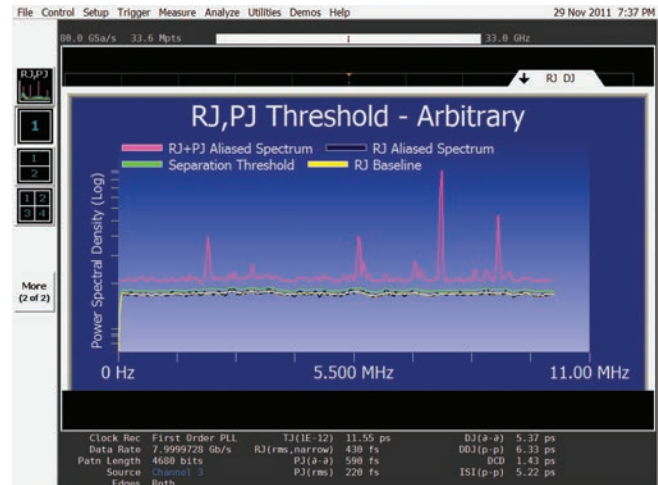

The RJ/PJ threshold tools, provides more jitter analysis

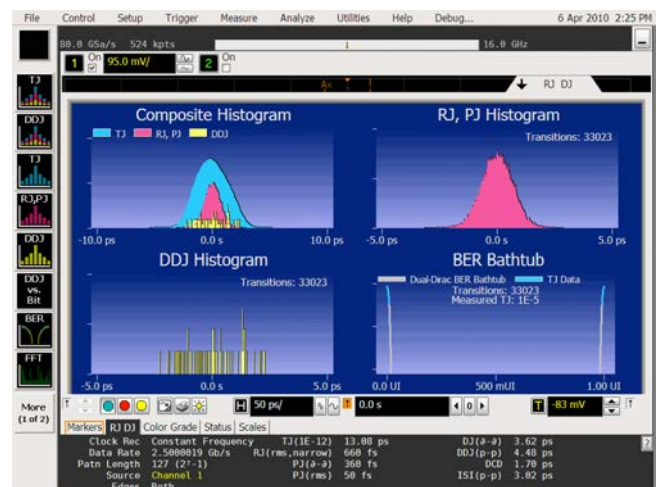

Jitter separation makes debugging your device easy

Analysis Tools: EZJIT Complete (Standard on DSA Models)

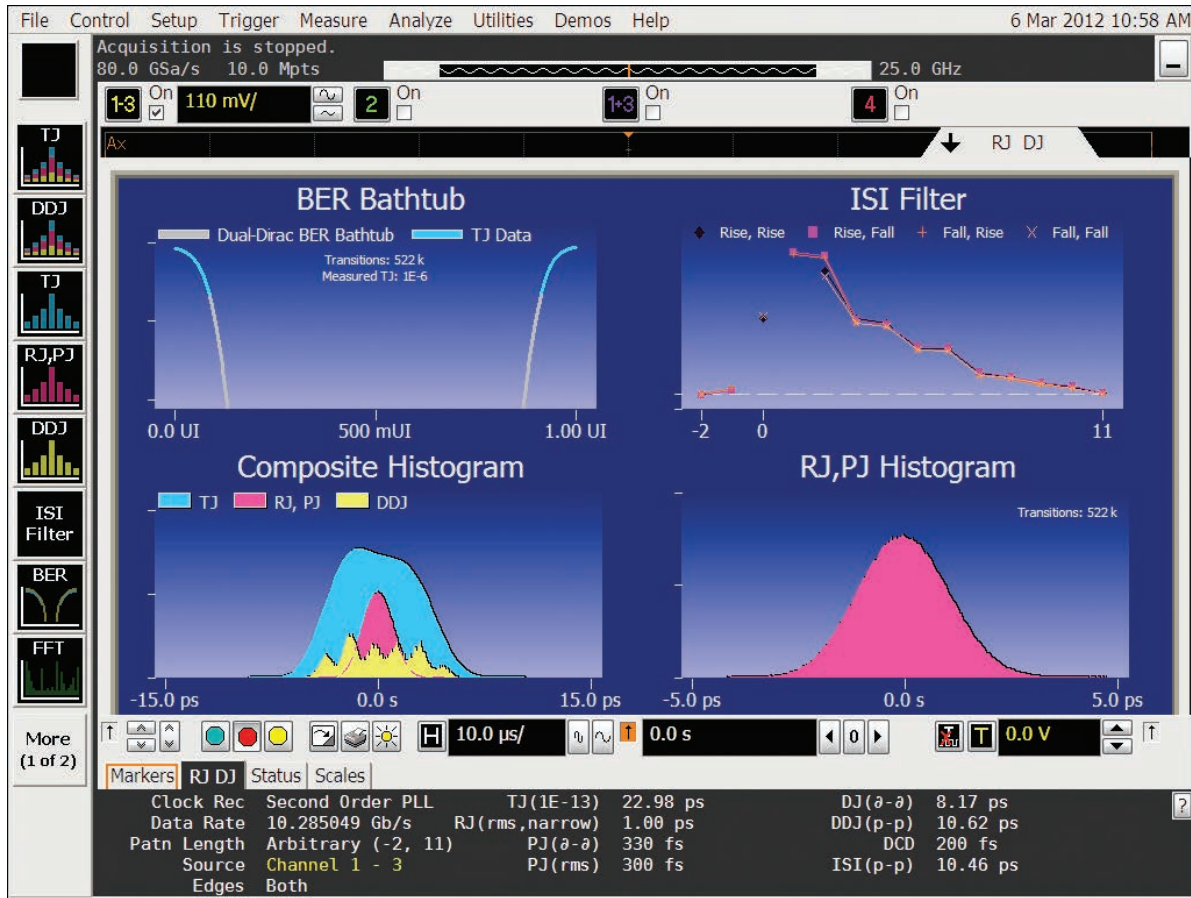

Discover signal anomalies to the noise of the waveform

More than your standard jitter package

In order to efficiently determine root cause for any type of signal degradation in the amplitude domain, you must first determine whether the problem is caused by random or deterministic sources. In order to help you accomplish this task, EZJIT Complete takes analysis techniques used in the time domain (jitter analysis) and extends them into the amplitude domain.

More than just an eye contour

EZJIT Complete is an in-depth view into impairments related to signal levels – either logic ones or logic zeroes – deviating from their ideal positions. Some tools simply provide a view of an eye contour, but provide no real measurement data other than nice graphics.

EZJIT Complete uses separation techniques to allow each bit to be examined to determine correlated effects and to make multiple measurements on individual bits to determine uncorrelated effects. Use FFTs to analyze the frequency domain and extract random components. Dual-Dirac modeling techniques are also carried from the jitter domain and used in the interference domain.

Key measurements

With EZJIT Complete, Q-Series scopes offer the following unique measurements:

- Total interference (TI)
- Deterministic interference (DI)
- Random noise (RN)
- Periodic interference (PI)
- Inter-symbol interference (ISI)
- RIN (dBm or dB/Hz)
- Q-factor

Analysis Tools: InfiniiSim (Options 014 and 015)

The most advanced waveform transformation software helps you render waveforms anywhere in a digital serial data link

InfiniiSim waveform transformation toolset provides the most flexible and accurate means to render waveforms anywhere in a digital serial data link. The highly configurable system modeling enables you to remove the deleterious effects of unwanted channel elements, simulate waveforms with channel models inserted, view waveforms in physically improbable locations, compensate for loading of probes and other circuit elements, and do so simply and quickly on your tool of choice, the 90000 Q-Series at up to 63 GHz of bandwidth.

Circuit models to define your setup

The InfiniiSim waveform transformation toolset provides a graphical user interface for you to define your system as you understand it and even make it arbitrarily complex. You do this by selecting topologies and defining circuit blocks.

Model reflections

With the InfiniiSim waveform transformation toolset, you can transform signals with confidence, whether you are inserting or removing channel elements or relocating the measurement plane. InfiniiSim's advanced toolset lets you model up to 27 different elements at once and model the interaction between elements. Only toolsets with the ability to model more than one element will properly reflect a model including the oscilloscope's input. The 90000 Q-Series scopes provide their own s11 parameter to allow modeling of their own input.

Model your system with as much detail as you need

InfiniiSim features the model setup that best matches your design. Whether it is a simple single-element model or an advanced general-purpose model with up to 27 elements in the link, you can perfectly model your design and simulate the exact probing point you want.

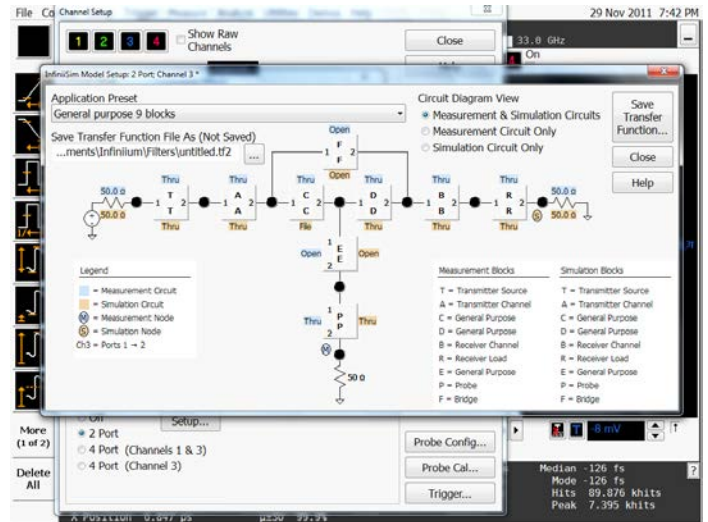

Analysis Tools: Serial Data Equalization (Option 012)

Significantly reduce receiver errors by opening even tightly shut eyes through equalization emulation

Serial data equalization for the 90000 Q-Series provides fast and accurate equalization using decision feedback equalization (DFE), feed-forward equalization (FFE), and continuous-time linear equalization (CTLE) modeling in real time. Serial data equalization software allows you to input your own self-designated tap values to verify your design. If you prefer, the software will find the optimal tap values for you. CTLE allows DC gain and two-pole modeling.

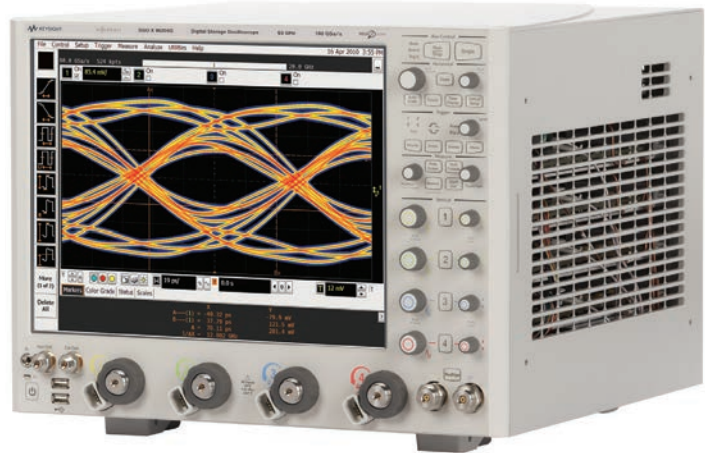

Analysis Tools: InfiniiScan (Option 009)

Trigger on events that hardware triggers can't handle

InfiniiScan software allows you to use an oscilloscope to identify signal integrity issues that hardware triggering is unable to find in your electronic designs. This innovative software scans through thousands of acquired waveforms per second to help you isolate signal anomalies, saving you time and improving designs.

Innovative triggers

The zone qualify finder allows you to draw a "must pass" or "must not pass" zone on the oscilloscope screen to visually determine the event identify condition. If you can see the event of interest on the screen, you can create a trigger that will isolate it, saving significant time over some complicated hardware triggers.

Other triggers include non-monotonic edge, measurement limit search, runt, and pulse width.

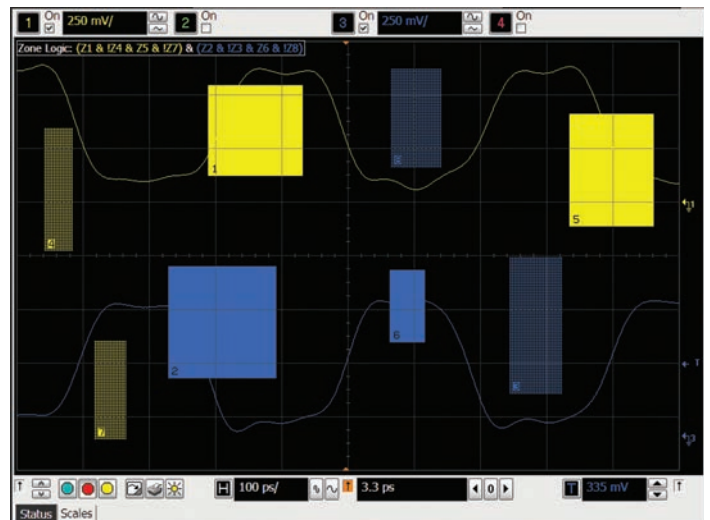

Draw zones on your screen for a unique triggering experience

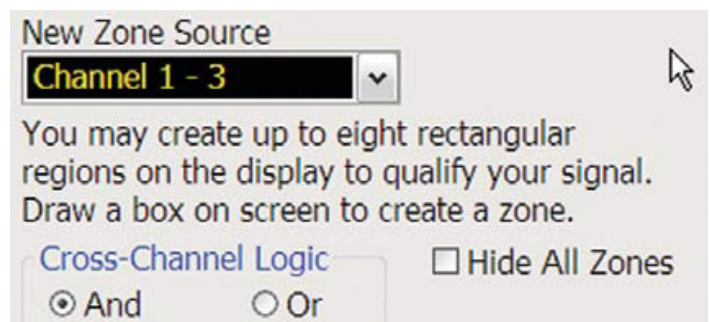

By combining InfiniiScan and hardware-accelerated math, you can even trigger on differential math signals

Analysis Tools: N8900A InfiniiView Oscilloscope Analysis Software

View and analyze away from your scope and target system

Ever wish you could do additional signal viewing and analysis away from your scope and target system? Now you can. Capture waveforms on your scope, save to a file, and recall into Keysight's InfiniiView application.

View and analyze anywhere your PC goes

Take advantage of large high-resolution and multiple displays found in your office. Use familiar scope controls to quickly navigate and zoom in to any event of interest. Use auto measurements and functions for additional insight.

Share scope measurements more easily across your team

You can share entire data records instead of being limited exclusively to static screen shots.

Create more useful documentation

Use features such as right-click cut-and-paste to move screen images between applications, without ever having to save the image to a file. Add up to 100 bookmark annotations and up to 20 simultaneous measurements.

Need advanced analysis capability?

InfiniiView includes a variety of upgrade options including serial decode upgrades for a variety of serial buses, jitter analysis, and serial data analysis.



InfiniiView software works with all of Infiniiium's applications



Use InfiniiView to find signal anomalies, such as power supply coupling



Peak search capability makes InfiniiView a frequency domain tool

Analysis Tools: User-Defined Function (Option 065)

Combine Infiniium and MATLAB for even more analysis

Enhance the Q-Series with a seamless gateway to powerful MATLAB analysis functionality. User-defined function software adds new analysis capabilities to the Q-Series, beyond traditional math/analysis features. Now you have the freedom to develop your own math functions or filters using MATLAB and its Signal Processing Toolbox. With a seamless integration to MATLAB, Keysight Infiniium oscilloscopes allow you to display your math and analysis functions live on the oscilloscope screen, just like any other scope's standard functions.

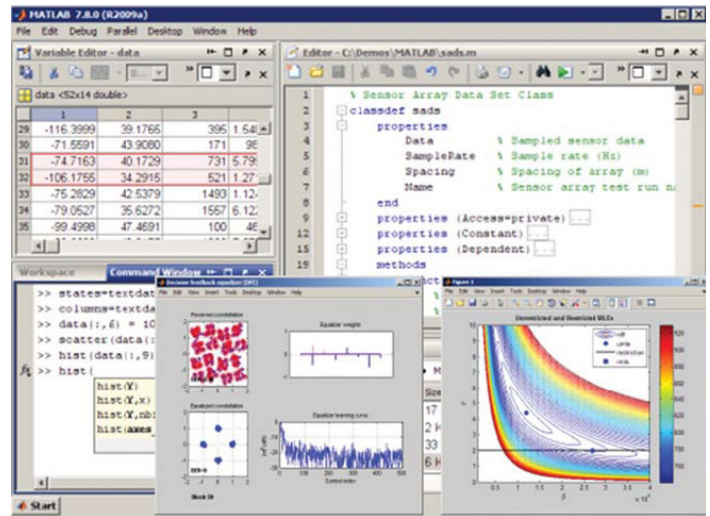

Analysis Tools: Complete List of Analysis Software

Analysis tools	Description	Option	Standalone
PrecisionProbe	Characterize and compensate for loss from your input to your oscilloscope to 33 GHz	001	N2809A-001
PrecisionProbe Advanced	Go a step further, characterize and compensate for loss from your input to your oscilloscope to 63 GHz	827	N2807A
InfiniiScan	Trigger on unique events including using zones on multiple channels and non-monotonic edges	009	N5414B
EZJIT	Basic jitter analysis with measurement trending, time interval error and many more measurements	002 ¹	E2681A
EZJIT Plus	Get in-depth analysis of your jitter by decomposing your jitter	004 ¹	N5400A
EZJIT Complete	Understand your full real time by decomposing the noise that is impacting your margins	070 ¹	N8823A
Serial data analysis	Recover clocks to 120 Gbs/s and view real-time eyes. Run mask testing	003 ¹	E2688A
Serial data equalization	Properly emulate your design equalizers including FFE, CTLE and DFE	012	N5461A
InfiniiSim Basic	Waveform transformation software to remove or add three elements in your link	013	N5465A-001
InfiniiSim Advanced	Waveform transformation software to remove or add 27 elements in your link	014	N5465A-002
InfiniiView	Put your scope onto your PC and maximize Infiniium's analysis tools with a true offline analysis engine	–	N8900A
User-defined function	Create custom functions that run live on your oscilloscope with MathWorks MATLAB software	010	N5430A
MATLAB Basic	Purchase an introductory MATLAB software package to acquire scope measurements into the MATLAB environment	061	–
MATLAB Standard	Purchase a typical MATLAB software package, signal processing and filter design toolboxes on the same PO as your scope	062	–
User-defined function with MATLAB	Create and execute custom functions that run live on your oscilloscope. Includes MATLAB standard software (Option 062)	065	N8806A

1. Standard on DSA model oscilloscopes.

Compliance and Automated Testing

Today's demanding environment means you have much less time to understand the intricacies of the technologies you are testing. You also have less time to develop and test automation software that is designed to increase measurement throughput and decrease time to market. Keysight's compliance applications save you time and money with measurement automation built into the compliance application. No longer do valuable resources need to be exclusively tied to writing automation software – instead they can be deployed to designing the next big project.

Compliance applications that run on Q-Series oscilloscopes are certified to test to the exact specifications of each technology standard. If a test passes on the Q-Series scope in your lab, you can be assured that it will pass in test labs and at plug fests worldwide. Keysight experts on technology boards and industry standards committees help define compliance requirements. As a result, you can be sure that Q-Series oscilloscope tools deliver to critical specifications. Setup wizards combined with intelligent test filtering give you confidence you're running the right tests. Comprehensive HTML reports with visual documentation and pass/fail results guarantee that critical information is retained on each test.

Quick and easy automated switching

Only Keysight's Q-Series oscilloscopes feature compliance applications with both the user-defined application's add-in capability and integrated PrecisionProbe compensation. Switch paths can vary in their characteristics and have unwanted loss. By enabling PrecisionProbe in its compliance applications, Q-Series scopes allows you to characterize and compensate for every path in the switch, making every path's frequency response identical in both magnitude and phase. These tools makes switch automation quick and painless. The Q-Series and its compliance applications make automation more automated than ever. Your technicians no longer need to spend valuable time physically changing connections.

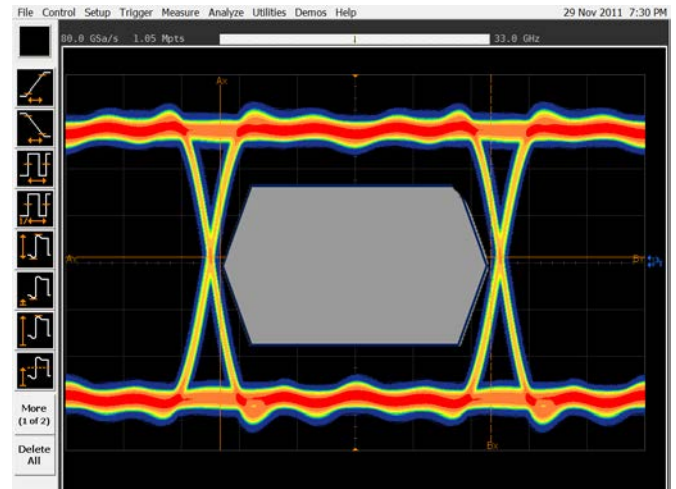

Compliance applications make testing to today's technologies standards easy

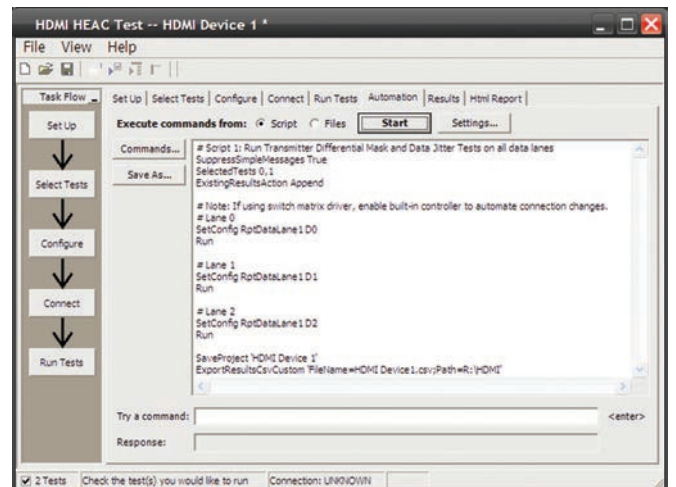

The remote programming interface makes it easy to control automation applications via your PC

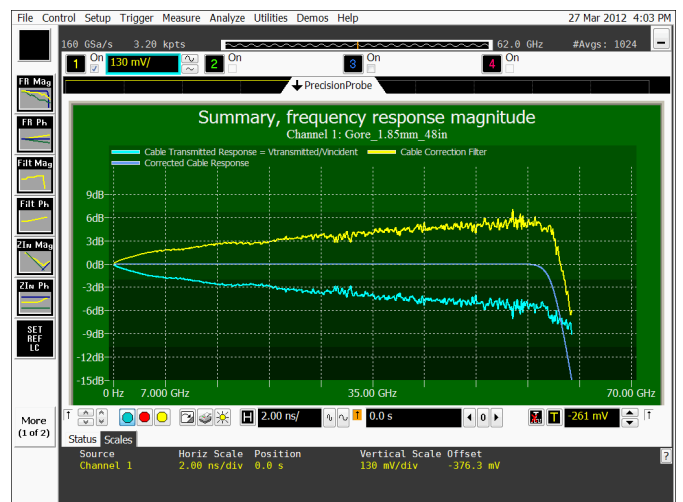

PrecisionProbe is fully integrated in Q-Series automation applications

Compliance and Automation Testing: Thunderbolt



Verify and debug your Thunderbolt designs more easily and ensure compliance

Thunderbolt is becoming increasingly popular as an interface for connecting devices to a computer through a bus. Thunderbolt combines PCI Express and DisplayPort into a serial data port that can be transmitted longer distances with less expensive cables.

Thunderbolt technology must work with other devices and must pass compliance. Keysight provides full compliance for the Thunderbolt technology and the 90000 Q-Series is a key part of transmitter compliance. Use the Thunderbolt software to debug your Thunderbolt designs and ensure compliance. With four channels of real time oscilloscope bandwidth at 33 GHz, the 90000 Q-Series is ideal for looking at two differential pairs for the Thunderbolt technology.

Keysight's Thunderbolt compliance application features to test the following specifications:

- Eye pattern testing
- Jitter testing
- TJ, DJ, RJ
- AC common mode
- Rise and fall times

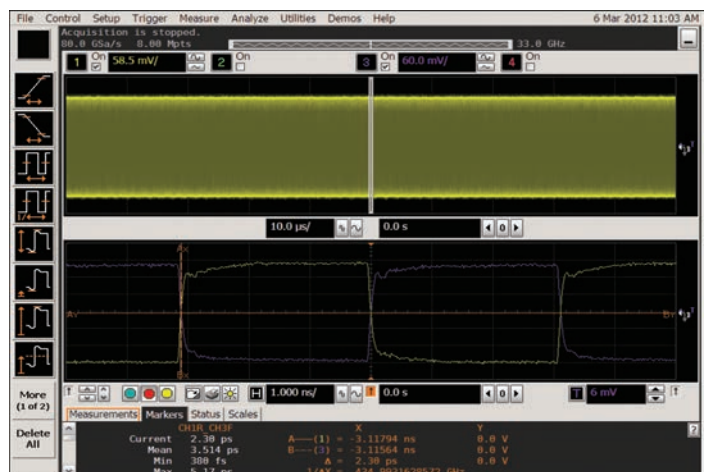
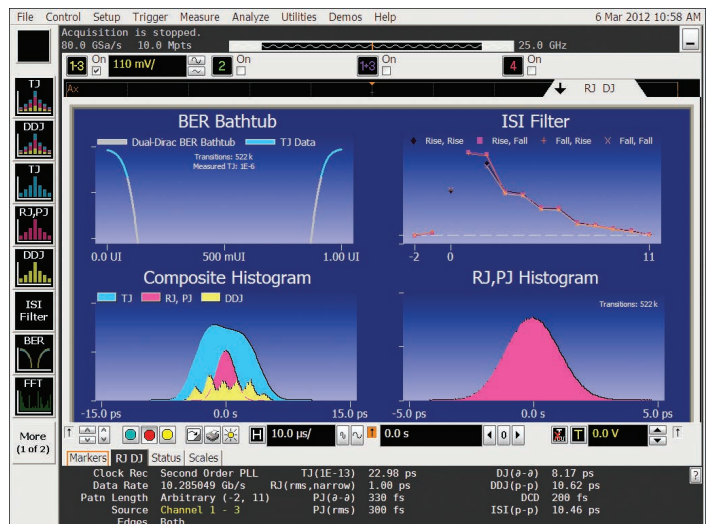

Compliance and Automation Testing: User-Defined Application (Option 040)

Custom automation for your Q-Series oscilloscope

The user-defined application is the only fully customizable automated environment made for an oscilloscope by an oscilloscope designer. It provides full automation, including the ability to control other Keysight instruments, external applications such as MATLAB and your DUT software.

Simplify your automation

The user-defined application (UDA) makes automation simple. The application takes the Infiniium compliance application framework and gives you full access to its interface. UDA allows for automation testing in as little as one minute. Use UDA to control other Keysight instruments such as signal generators and network analyzers to create a full suite of measurements.

Full measurement report

No automation would be complete without a simple-to-view and easy-to-understand report. UDA provides a full report of the pass/fail criteria you have provided.

Add-in capability

Ever wanted to add testing to your compliance applications? All Infiniium compliance applications support the industry's most flexible testing mechanism with UDA add-in capability. Create the custom testing you need and then plug it into your compliance application to expand the application to your testing needs. UDA add-in capability is only available on Infiniium oscilloscopes.

PrecisionProbe and switch compatibility

UDA makes automation of switches in your system simple and accurate. Use PrecisionProbe to characterize the path of the switch and then let UDA's unique GUI switch between every input in your switch system. Every input can look identical in its frequency response thanks to this advanced technology.

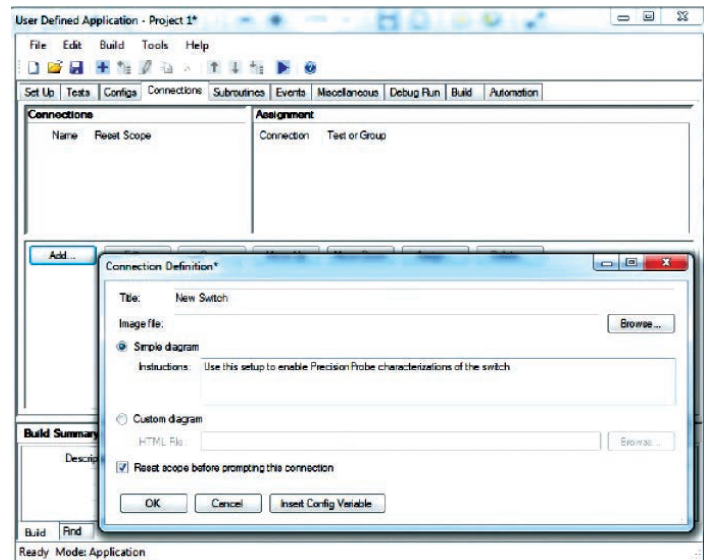
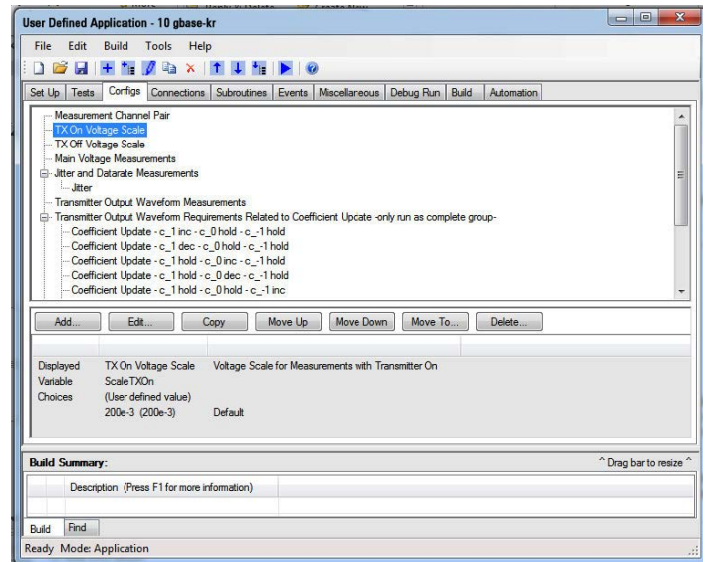

Compliance and Automation Testing: Switch Matrix Support

Comprehensive testing, easily achieved

Eliminate reconnections (reducing errors)

Compliance applications on Keysight's 90000 Q-Series now support a switch matrix, making testing simple by automating test for each lane of a multi-lane bus. Typical testing requires reconnecting the oscilloscope each time that you switch a lane, which causes wasted time and inaccuracies. The 90000 Q-Series solves this problem by supporting switch matrix through its compliance test. Simply connect the switch to the oscilloscope and all the lanes, and then hit run to complete full testing of your entire device.

Maintain accuracy

The framework fully supports Keysight's PrecisionProbe software (N2809A) and InfiniiSim software (N5465A). This gives you the ability to characterize every switch path to the device under test (both magnitude and skew) and ensure that all of them maintain the same level of accuracy.

Customize your testing

Use the remote programming interface (standard feature on the 90000 Q-Series) and N5467A user-defined application for device control, instrument control and test customization.

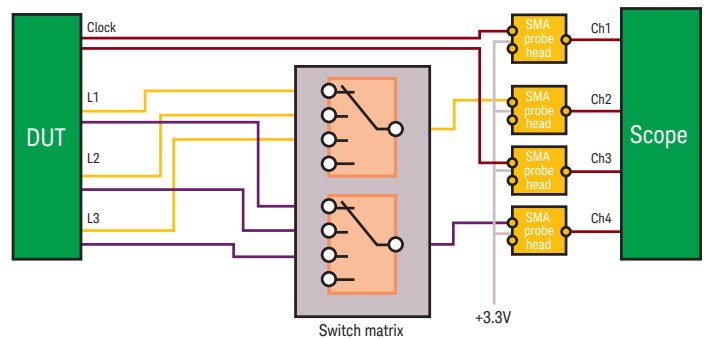

Typical switch configuration for HDMI testing (now supported in the 90000 X-Series)

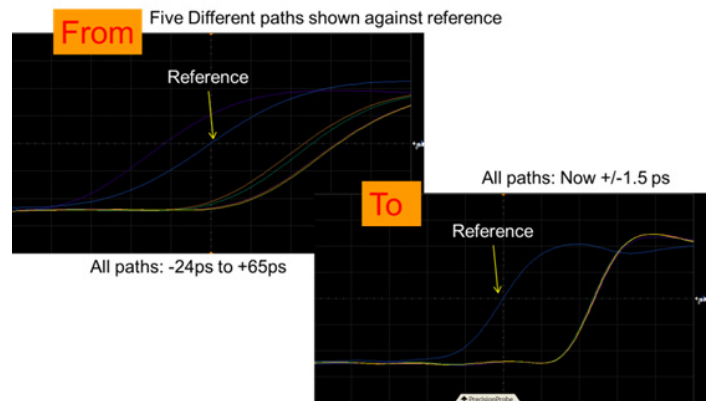

Skews between switch paths are easily maintained with Keysight's unique software

Compliance and Automation Testing: Other Options on Q-Series Oscilloscopes

In the previous pages we have highlighted a few of the key technologies that benefit from the industry's only four-channel oscilloscope with more than 20 GHz bandwidth. The Q-Series offers over 20 compliance applications and the list continues to grow. All applications are fully compatible with InfiniiSim, PrecisionProbe and UDA's unique add-in capability.

Compliance tools	Description	Option	Standalone
PCI Express Gen 1/2/3/4	Guarantee your PCI Express Gen4 designs	112	N5393F
HDMI 2.0 compliance	Quickly verify and debug your high-definition multimedia interface	077	N5399C
SAS-2 compliance	Automatically execute SAS electrical checklist tests at each of the IT, CT, IR, and CR interface points	043	N5412A
SAS-3 compliance	Automatically execute SAS electrical checklist tests at each of the IT, CT, IR, and CR interface points	076	N5412C
DisplayPort source compliance	Verify and debug your DisplayPort interface designs for sink and source ICs, motherboard systems, computers, and graphics cards	045	U7232B
DDR1 verification	Save time with automated testing based on JEDEC DDR1 and LPDDR1 specifications	031	U7233A
DDR3 verification	Save time with automated testing based on JEDEC DDR3 specifications	032	U7231B
DDR2 verification	Save time with automated testing based on JEDEC DDR2 and LPDDR2 specifications	033	N5413B
GDDR5 verification	Save time with automated testing based on JEDEC GDDR5 specifications	-	U7245A
10GBASE-KR compliance	Test to IEEE 802.3 clause 49 over a single backplane lane	074	N8814A
MIPI D-PHY verification	Execute D-PHY electrical checklist tests for CSI and DSI architectures	035	U7238B
MIPI M-PHY verification	Execute M-PHY electrical tests	047	U7249B
Energy Efficient Ethernet	Debug your 1000BASE-T, 100BASE-TX, and 10BASE-T Ethernet designs	060	N5392B
10-GBASE-T compliance	Coverage of the 10GBASE-T transmitter electrical specifications as described in section 55.5.3 of IEEE 802.3an-2006	036	U7236A
XAUI compliance	XAUI validation with 10GBASE-CX4, CPRI, OBSAI, and Serial RapidIO support	030	N5431A
SATA 6G compliance	Automated compliance testing for 1.5-Gbps, 3.0-Gbps and 6.0-Gbps SATA, and eSATA transmitter (PHY/TSG/OOB tests)	038	N5411B
User-defined application	Fully customizable automated application for your Infiniium oscilloscope	040	N5461A
USB 2.0 compliance	USB-IF recognized compliance for low/full and low/full/high-speed USB automated electrical test	029	N5416A
USB 3.0 compliance	Validate and debug your USB 3.0 silicon, host, hub or device	041	U7243A
USB HSIC	Validate and debug USB high speed inter-connect devices	046	U7248A
MHL compliance	Validates MHL source designs as found in portable products such as cell phones and tables according to the MHL 1.2 standard	054	N6460A
Thunderbolt compliance	Measure the transmitter with the accuracy of the 90000 Q-Series	059	N6463A

Protocol Analysis

Q-Series oscilloscopes comes with more than 15 protocol decoders, including the industry's only 64/66b decoder. The Q-Series protocol tools feature time-correlated markers that let you easily move between the listing window and the waveform. Protocol tools can be used on up to four lanes simultaneously.

These unique tools feature search and trigger capability that lets you scan through the waveform to find the trigger condition that interests you. Protocol tools are fully compatible with Infiniium's serial data analysis and are available on the Infiniium offline tool.

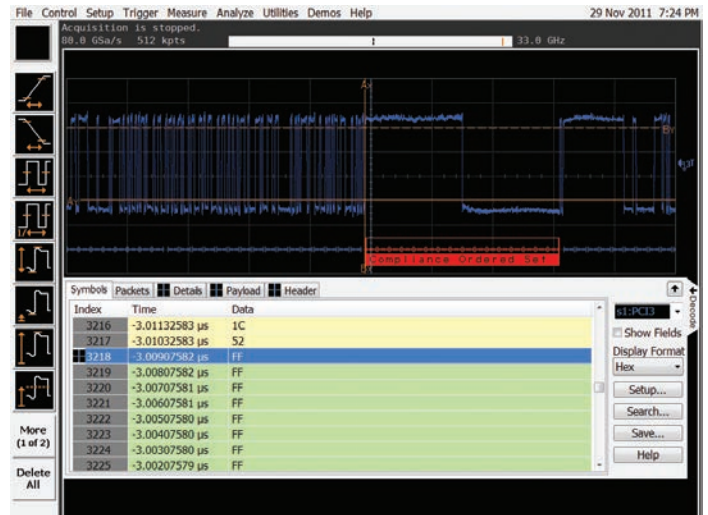

Protocol	Description	Option	Part number
PCI Express Gen3	Time-correlated views of physical and transaction layer errors. 128/130-bit decoding on Gen3 traffic	049	N8816A
Ethernet 10GBASE-KR	Full protocol analysis for 10GBASE-KR 64/66-bit decoder	048	N8815A
USB 3.0	Set up your scope to show USB 3.0 SuperSpeed protocol decode in less than 30 seconds		N8805A
SATA/SAS	Simplify the validation of your SATA/SAS designs with the full-capability protocol viewer for 3 G, 6 G and 12 Gbit/s	018	N5436A
DigRF® v4	Extend your scope capability with DigRF® v4 triggering and decode	051	N8807A
I2C/SPI	Extend your scope capability with I ² C and SPI triggering and decode	007	N5391A
RS232/UART	Easily view the information sent over an RS-232 RS-422, RS-485 or other UART serial buses	015	N5462A
USB 2.0	Trigger on and quickly view USB packets, payload, header and detailed information	016	N5464A
PCI Express® Gen1 and 2	Quickly view packets, payload, header, and detailed information	017	N5463A
MIPI D-PHY	Easily view the information sent over MIPI® serial buses	019	N8802A
CAN/FlexRay	View both protocol-layer information and physical-layer signal characteristics for CAN, LIN, CAN-FD, and FlexRay buses	063	N8803C
JTAG	Eliminate the difficult task of manually determining JTAG TAP controller states, instruction, and data register decode	042	N8817A
SVID	Decode and search on SVID technology	056	N8812A
Unipro decode	Decode at the protocol level	052	—

Keysight Infiniium Oscilloscope Portfolio

Keysight's Infiniium oscilloscope lineup includes bandwidths from 600 MHz to 63 GHz. Use the following selection guide to determine which best matches your specific needs. All Infiniium real-time oscilloscopes feature the following:

- World's highest bandwidth on 4 channels in a single frame
- Industry's lowest noise floor
- Full PrecisionProbe compatibility



		9000 Series	90000A Series	90000 X-Series	90000 Q-Series
Available bandwidths	Up to 4 GHz	600 MHz, 1 GHz, 2.5 GHz, 4 GHz	2.5 GHz, 4 GHz		
	6 to 16 GHz		6 GHz, 8 GHz, 12 GHz, 13 GHz	16 GHz	
	20 to 63 GHz			20 GHz, 25 GHz, 33 GHz	20 GHz, 25 GHz, 33 GHz, 50 GHz, 63 GHz
Max upgradable bandwidth		4 GHz	13 GHz	33 GHz	63 GHz
Sample rate (2-channel/4-channel)		10/20 GSa/s	40/40 GSa/s	80/40 GSa/s	160/80 GSa/s
Channel inputs and connector types		50 Ω and 1 MΩ, BNCs	50 Ω, BNCs	50 Ω, 2.92 and 3.5 mm SMAs	50 Ω, 1.85 mm, 2.4, mm 2.92 and 3.5 mm, SMAs
Memory depth (standard/max)		20 M/1 Gpts	20 M/2 Gpts	20 M/2 Gpts	20 M/2 Gpts
MSO models		Yes	No	No	No
Supported InfiniiMax probe families		InfiniiMax 2	InfiniiMax 2	InfiniiMax 3 InfiniiMax 2 with adapter	InfiniiMax 3 InfiniiMax 2 with adapter

Achieve your Real Edge

Configure your high-performance real-time oscilloscope solution today

Get the most out of your oscilloscope investment by choosing options and software to speed your most common tasks. Configure your Infiniium Q-Series oscilloscope in three easy steps. Use option numbers when ordering at time of purchase. Use model numbers to add to an existing scope.

Choose your oscilloscope

Oscilloscope	Description
DSAX96204Q	63-GHz digital signal analyzer ¹
DSOX96204Q	63-GHz digital signal oscilloscope
DSAX95004Q	50-GHz digital signal analyzer ¹
DSOX95004Q	50-GHz digital signal oscilloscope
DSAX93304Q	33-GHz digital signal analyzer ¹
DSOX93304Q	33-GHz digital signal oscilloscope
DSAX92504Q	25-GHz digital signal analyzer ¹
DSOX92504Q	25-GHz digital signal oscilloscope
DSAX92004Q	20-GHz digital signal analyzer ¹
DSOX92004Q	20-GHz digital signal oscilloscope

1. DSA models come standard with 50 Mpts memory, EZJIT, EZJIT Plus, EZJIT Complete and serial data analysis software.

All models come with front cover, power cord, keyboard, mouse, stylus, 3.5 mm male-to-male calibration cable (54916-61626), 3.5 mm male to 2.4 mm male calibration cable (54932-61630), ESD strap and (5) coax adapters. (5061-5311). 50 and 63 GHz models come with (2) additional 1.85 female-to-female adaptors (54932-68712).

All models come standard with removable SSD hard drive (additional hard drives can be ordered as Option 827).

Memory options

Description	Options
50 Mpts/ch memory	DSOX90000-050 ²
100 Mpts/ch memory	DSOX90000-100
200 Mpts/ch memory	DSOX90000-200
500 Mpts/ch memory	DSOX90000-500
1 Gpt/ch memory	DSOX90000-01G
2 Gpts/ch memory	DSOX90000-02G



Description	Options
ANSI Z540 compliant calibration	DSOX90000-A6J
ISO17025 calibration	DSOX90000-1A7
DVD RW	DSOX90000-820
GPIO card-interface	—
Performance verification de-skew fixture for InfiniiMax III probe	DSOX90000-808
Rackmount kit option	DSOX90000-1CM
Transit case	—

2. Standard on DSA models.

Achieve your Real Edge (Continued)

Configure your high-performance real-time oscilloscope solution today

InfiniiMax III probe heads are recommended for InfiniiMax III N2800A/01A/02A/03A probe amplifiers.

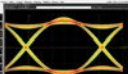
Probe heads	Model numbers	BW and input loading	Key features
Differential browser head 	N5445A	30 GHz, Cdiff = 35 fF, Cse = 50 fF, Rdiff = 100 kΩ, Rse = 50 kΩ	Z axis compliance and variable spacing from 20 to 125 mils, integrated LED lighting
ZIF probe head/tips 	N2838A 450 Ω ceramic PCB tip, N5439A head, N5440A 450 Ω tip set, N5447A 200 Ω tip ceramic	28 GHz, Cdiff = 95 fF, Cse = 130 fF, with N2838A: Cdiff = 32 fF, Cse = 44 fF, with N5440A: Rdiff = 100 kΩ, Rse = 50 kΩ With N5447A: Rdiff = 50 kΩ, Rse = 25 kΩ	Extremely low loading, Variable spacing from 5 to 80 mil, User replaceable damping resistor tips (N2838A only)
2.92 mm/3.5 mm/SMA probe head 	N5444A	28 GHz, N/A, 55 Ω to Vterm	Provides termination voltage of ± 4 V controlled by scope or externally
Solder-in head 	N5441A N2836A	16 GHz, Cdiff = 77 fF, Cse = 105 fF, Rdiff = 100 kΩ, Rse = 50 kΩ 26 GHz, Cdiff = 108 fF, Cse = 140 fF, Rdiff = 100 kΩ, Rse = 50 kΩ	Economical and semi-permanent connection, variable span of leads ranges from 5 mil to 80 mil

Upgrade your oscilloscope

Description	Model numbers
90000 X-Series to 90000 Q-Series upgrades³	
N2764AU-016	16 GHz 90000 X to 20 GHz 90000 X-Series upgrade ¹
N2764AU-020	20 GHz 90000 X to 20 GHz 90000 Q-Series upgrade
N2764AU-025	25 GHz 90000 X to 32 GHz 90000 X-Series upgrade ²
N2764AU-028	28 GHz 90000 X to 33 GHz 90000 Q-Series upgrade ²
N2764AU-033	32 GHz 90000 X to 33 GHz 90000 Q-Series upgrade
Upgrades within the 90000 Q-Series family	
N2764BU-025	Bandwidth upgrade – 20 to 25 GHz 90000 Q-Series
N2764BU-033	Bandwidth upgrade – 25 to 33 GHz 90000 Q-Series
N2764BU-050	Bandwidth upgrade – 33 to 50 GHz 90000 Q-Series
N2764BU-059	Bandwidth upgrade – 33 to 59 GHz 90000 Q-Series
N2764BU-062	Bandwidth upgrade – 50 to 63 GHz 90000 Q-Series
N2764BU-162	Bandwidth upgrade – 59 to 63 GHz 90000 Q-Series

1. Requires the purchase of N2764AU-020.

2. Requires the purchase of N2764AU-033.

3. Upgrade will have a new serial number.

Memory upgrades

Memory	Model Number (post-sales for existing oscilloscopes)
Upgrade to 50 Mpts/ch	N2810-050
Upgrade to 100 Mpts/ch	N2810-100
Upgrade to 200 Mpts/ch	N2810-200
Upgrade to 500 Mpts/ch	N2810-500
Upgrade to 1 Gpts/ch	N2810-01G
Upgrade to 2 Gpts/ch	N2810-02G

Specifications

Vertical	92004Q	92504Q	93304Q	95004Q	96204Q
Typical analog bandwidth (3 dB)	20 GHz	25 GHz	33 GHz	50 GHz	63 GHz
Analog bandwidth (3 dB) *	20 GHz	25 GHz	32 GHz	50 GHz	62 GHz
2 channel sample rate	80 GSa/s	80 GSa/s	80 GSa/s	160 GSa/s	160 GSa/s
4 channel sample rate	80 GSa/s	80 GSa/s	80 GSa/s	80 GSa/s	80 GSa/s
Rise time/fall time	92004Q	92504Q	93304Q	95004Q	96204Q
10 to 90% ⁴	22.0 ps	17.6 ps	13.3 ps	8.8 ps	7.0 ps
20 to 80%	15.6 ps	12.4 ps	9.4 ps	6.2 ps	4.9 ps
Input impedance ³	50 Ω, ± 3%				
Sensitivity ²	1 mV/div to 1 V/div				
Input coupling	DC				
Vertical resolution ¹	8 bits, ≥ 12 bits with averaging				
Channel to channel isolation (any two channels with equal V/div settings)	RealEdge (1.85 mm) channels DC to 40 GHz: 70 dB 40 GHz to BW: 60 dB Standard (3.5 mm) channels DC to BW: 70 dB				
DC gain accuracy *	± 2% of full scale at full resolution channel scale (± 2.5% for 5 mV/div)				
Maximum input voltage	± 5V for steady state and transient measurements				
Offset range	Vertical sensitivity	Available offset		Available offset (oscilloscope with N7010A voltage termination adapter)	
	1 to 49 mV/div	± 0.4 V		± 4 V	
	50 to 79 mV/div	± 0.7 V		± 4 V	
	80 to 134 mV/div	± 1.2 V		± 4 V	
	135 to 239 mV/div	± 2.2 V		± 4 V	
	240 mV/div to 1 V/div	± 4.0 V		± 4 V	
Offset accuracy *	≤ 3.5V: ± (2% of channel offset + 1% of full scale) + 1 mV > 3.5V: ± (2% of channel offset + 1% of full scale)				
Dynamic range	± 4 div from center screen				
DC voltage measurement accuracy	Dual cursor: ± [(DC gain accuracy) + (resolution)] Single cursor: ± [(DC gain accuracy) + (offset accuracy) + (resolution/2)]				
RMS noise floor (scope only)					
V/div	92004Q	92504Q	93304Q	95004Q	96204Q
10 mV	0.41 mV (rms)	0.48 mV (rms)	0.60 mV (rms)	0.90 mV (rms)	1.0 mV (rms)
50 mV	1.46 mV (rms)	1.7 mV (rms)	2.00 mV (rms)	2.90 mV (rms)	3.3 mV (rms)
100 mV	2.90 mV (rms)	3.3 mV (rms)	3.90 mV (rms)	5.70 mV (rms)	6.4 mV (rms)
1 V	28.6 mV (rms)	32.5 mV (rms)	38.1 mV (rms)	56.7 mV (rms)	63 mV (rms)

* Denotes warranted specifications, all others are typical. Specifications are valid after a 30-minute warm up period, and ± 5° C from annual calibration temperature.

1. Vertical resolution for 8 bits = 0.4% of full scale, for 12 bits = 0.024% of full scale.
2. Full scale is defined as 8 vertical divisions. Magnification is used below 7.5 mV/div. Below 7.5 mV/div, full-scale is defined as 60 mV/div. The major scale settings are 5 mV, 10 mV, 20 mV, 50 mV, 100 mV, 200 mV, 500 mV, and 1 V. Input impedance is valid when V/div scaling is adjusted to show all waveform vertical values within scope display.
3. Rise time calculated by using 0.45/BW for (10 to 90%) rise time.

Specifications (Continued)

Horizontal	
Main timebase range	2 ps/div to 20 s/div real-time (RealEdge is 1 ps/div to 20 s/div real time)
Main timebase delay range	200 s to -200 s real-time
Zoom timebase range	1 ps/div to current main time scale setting
Channel deskew	± 1 ms range, 10 fs resolution
Time scale accuracy *	± [0.1 ppm (immediately after calibration) ± 0.1 ppm/year (aging)]
Delta-time measurement accuracy	

$$5 \cdot \sqrt{\left(\frac{\text{Noise}}{\text{SlewRate}}\right)^2 + \text{SampleClock jitter}^2} + \frac{\text{TimeScaleAccy} \cdot \text{Reading}}{2} \text{ s rms}$$

Delta-time measurement accuracy
ABSOLUTE > 256 averages

$$0.35 \cdot \sqrt{\left(\frac{\text{Noise}}{\text{SlewRate}}\right)^2 + \text{SampleClock jitter}^2} + \frac{\text{TimeScaleAccy} \cdot \text{Reading}}{2} \text{ s rms}$$

Sample clock jitter	Acquired time range	Internal timebase reference	External timebase reference
	10 ms		50 fs rms (1.85 mm input) 75 fs rms (3.5 mm input)
10 to 100 ms		190 fs rms	190 fs rms
100 ms to 1 s		500 fs rms	190 fs rms
> 1 s			190 fs rms

Jitter measurement floor (6a, 6b, 6c)

TIE:

$$\sqrt{\left(\frac{\text{Noise}}{\text{SlewRate}}\right)^2 + \text{SampleClock jitter}^2} \text{ s rms}$$

Periodic jitter:

$$\sqrt{2} \cdot \sqrt{\left(\frac{\text{Noise}}{\text{SlewRate}}\right)^2 + \text{SampleClock jitter}^2} \text{ s rms}$$

Cycle-cycle:

$$\sqrt{3} \cdot \sqrt{\left(\frac{\text{Noise}}{\text{SlewRate}}\right)^2 + \text{SampleClock jitter}^2} \text{ s rms}$$

Specifications (Continued)

Acquisition	92004Q	92504Q	93304Q	95004Q	96204Q			
Maximum real-time sample rate								
(2 channels)	80 GSa/s			160 GSa/s 2ch				
(4 channels)	80 GSa/s			80 GSa/s				
Memory depth per channel	4 channels (all models)			2 channels (all models)				
Standard	20 Mpts			40 Mpts				
Option 050M	50 Mpts (standard on DSA models)			100 Mpts (standard on DSA models)				
Option 100	100 Mpts			200 Mpts				
Option 200	200 Mpts			400 Mpts				
Option 500	500 Mpts			1 Gpt				
Option 01G	1 Gpt			1 Gpt				
Option 02G	2 Gpts			2 Gpts				
Maximum acquired time at highest real time resolution								
Real-time resolution	80 GSa/s			160 GSa/s				
Resolution	12.5 ps			6.25 ps				
Standard (20 M)	0.25 ms			0.125 ms				
Option 50 M	0.625 ms			0.3125 ms				
Option 100	1.25 ms			0.625 ms				
Option 200	2.5 ms			1.25 ms				
Option 500	6.25 ms			3.125 ms				
Option 01G	12.5 ms			6.25 ms				
Option 02G	25 ms			12.5 ms				
Sampling modes								
Real-time	Successive single shot acquisitions							
Real-time with averaging	Selectable from 2 to 65534 (up to 200,000 with function)							
Real-time with peak detect	80 GSa/s (unavailable on RealEdge channels)							
Real-time with hi resolution	Real-time boxcar averaging reduces random noise and increases resolution (unavailable on RealEdge channels)							
Gaussian magnitude, linear phase	Slower filter roll off while maintaining linear phase							
Roll mode	Scrolls sequential waveform points across the display in a right-to-left rolling motion. Works at sample rates up to 10 MSa/s with a maximum record length of 40 Mpts							
Segmented memory ⁵	Captures bursting signals at max sample rate without consuming memory during periods of inactivity Maximum time between triggers is 562,950 seconds Re-arm time: 2.5 μ s							
	Memory depth:	20 M	50 M	100 M	200 M	500 M	1 G	2 G
	Max # of segments:	4096	8192	16384	32768	65536	131072	131072
Filters								
Sin(x)/x interpolation	On/off selectable FIR digital filter (2x, 4x, 8x, 16x settings) digital signal processing adds points between acquired data points to enhance measurement accuracy and waveform display							

5. Segmented memory is currently not supported on 50 and 63 GHz models of the 90000 Q-Series.

Specifications (Continued)

Hardware trigger	
Sensitivity	Internal low: 2.0 div p-p 0 to 22 GHz Internal high: 0.3 div p-p 0 to 18 GHz, 1.0 div p-p 0 to 22 GHz
Edge trigger bandwidth (Ch1 to Ch4)	> 20 GHz
Edge trigger bandwidth (AUX)	400 MHz
Minimum pulse width trigger	
Hardware	250 ps
Software (InfiniiScan)	40 ps
Level range	± 4 div from center screen or ± 4 V, whichever is smallest ± 5 V, also limit input signal to ± 5 V
Internal	
Auxiliary	
Sweep modes	Auto, triggered, single
Display jitter (displayed trigger jitter)	Equal to the TIE jitter measurement floor (internal edge triggering with JitterFree)
Trigger sources	Channel 1, Channel 2, Channel 3, Channel 4, aux, and line
Trigger modes	
Edge	Triggers on a specified slope (rising, falling or alternating between rising and falling) and voltage level on any channel or auxiliary trigger. Edge trigger bandwidth is > 20 GHz
Edge transition	
Edge then edge (time)	Trigger on rising or falling edges that cross two voltage levels in > or < the amount of time specified. Edge transition setting from 250 ps
Edge then edge (event)	
Glitch	The trigger is qualified by an edge. After a specified time delay between 10 ns to 10 s, a rising or falling edge on any one selected input will generate the trigger
Pulse width	The trigger is qualified by an edge. After a specified delay between 1 to 16,000,000 rising or falling edges, another rising or falling edge on any one selected input will generate the trigger Triggers on glitches narrower than the other pulses in your waveform by specifying a width less than your narrowest pulse and a polarity. Triggers on glitches as narrow as 125 ps. Glitch range settings: < 250 ps to < 10 s Trigger on a pulse that is wider or narrower than the other pulses in your waveform by specifying a pulse width and a polarity. Triggers on pulse widths as narrow as 125 ps. Pulse width range settings 250 ps to 10 s. Trigger point can be "end of pulse" or "time out"
Runt	Triggers on a pulse that crosses one threshold but fails to cross a second threshold before crossing the first again. Can be time qualified with minimum setting of 250 ps

Specifications (Continued)

Hardware trigger (Continued)	
Timeout	Trigger when a channel stays high, low, or unchanged for too long. Timeout setting: from 250 ps to 10 s
Pattern/pulse range	Triggers when a specified logical combination of the channels is entered, exited, present for a specified period of time or is within a specified time range or times out. Each channel can have a value of High (H), Low (L), or Don't care (X)
State	Pattern trigger clocked by the rising, falling or alternating between rising and falling edge of one channel
Window	Triggers on an event associated with a window defined by two-user adjustable thresholds. Event can be window "entered," "exited," "inside (time qualified)," or "outside (time qualified)" voltage range. Trigger point can be "cross window boundary" or "time out." Time qualify range: from 250 ps to 10 s
Video	Triggers from negative sync composite video, field 1, field 2, or alternating fields for interlaced systems, any field, specific line, or any line for interlaced or non-interlaced systems. Supports NTSC, PAL-M (525/60), PAL, SECAM (625/50), EDTV (480p/60), EDTV (576p/50), HDTV (720p/60), HDTV (720p/50), HDTV (1080i/60), HDTV (1080i/50), HDTV (1080p/60), HDTV (1080p/50), HDTV (1080p/30), HDTV (1080p/25), HDTV (1080p/24), and user-defined formats
Trigger sequences	Three stage trigger sequences including two-stage hardware (Find event (A) and Trigger event (B)) and one-stage InfiniiScan software trigger. Supports all hardware trigger modes except "edge then edge" and "video," and all InfiniiScan software trigger modes. Supports "delay (by time)" and "reset (by time or event)" between two hardware sequences. The minimum latency between "find event (A)" and "trigger event (B)" is 3 ns
Trigger qualification and qualifier	Single or multiple channels may be logically qualified with any other trigger mode
Trigger holdoff range	100 nS to 10 s
Trigger actions	Specify an action to occur and the frequency of the action when a trigger condition occurs. Actions include e-mail on trigger and execute "multipurpose" user setting
Software trigger (requires InfiniiScan event identification software – Option 009)	
Trigger modes	
Zone qualify	Software triggers on the user defined zones on screen. Zones can be specified as either "must intersect" or "must not intersect." Up to eight zones can be defined across multiple channels
Generic serial	Software triggers on NRZ-encoded data up to 8.0 Gbps, up to 80-bit pattern. Support multiple clock data recovery methods including constant frequency, 1st-order PLL, 2nd-order PLL, explicit clock, explicit 1st-order PLL, explicit 2nd-order PLL, Fibre Channel, FlexRay receiver, FlexRay transmitter (requires E2688A except for the constant frequency clock data recovery mode)
Measurement limit	Software triggers on the results of the measurement values. For example, when the "pulse width" measurement is turned on, InfiniiScan measurement software trigger triggers on a glitch as narrow as 75 ps. When the "time interval error (TIE)" is measured, InfiniiScan can trigger on a specific TIE value
Non-monotonic edge	Software triggers on the non-monotonic edge. The non-monotonic edge is specified by setting a hysteresis value.
Runt	Software triggers on a pulse that crosses one threshold but fails to cross a second threshold before crossing the first again. Unlike hardware runt trigger, InfiniiScan runt trigger can be further qualified via a hysteresis value

Specifications (Continued)

Hardware trigger (Continued)	
Maximum measurement update rate	> 50,000 measurement/s (one measurement turned on) > 250,000 measurement/s/measurement (ten measurements turned on)
Measurement modes	Standard, measure all edges mode
Waveform measurements	Peak to peak, minimum, maximum, average, RMS, amplitude, base, top, overshoot, preshoot, upper, middle, lower, overshoot, Vtime, Vpreshoot, crossing, pulse base, pulse amplitude, pulse top
Voltage	
Time	Rise time, fall time, positive width, negative width, burst width, burst period, burst interval, Tmin, Tmax, Tvolt, + pulse count, - pulse count
Clock	Period, frequency, duty cycle to duty cycle, phase, N-period
Data	Setup time, hold time
Mixed	Area, slew rate
Frequency domain	FFT frequency, FFT magnitude, FFT delta frequency, FFT delta magnitude, peak detect mode
Level qualification	Any channels that are not involved in a measurement can be used to level-qualify all timing measurements
Eye-diagram measurements	Eye height, eye width, eye jitter, crossing percentage, Q factor, and duty-cycle distortion
Jitter analysis measurements	Requires Option 002 (or E2681A), 004 (N5400A), or 070 (N8823A). Standard on DSA Series
Clock	Time interval error, N-period, period to period, positive width to positive width, neg width to neg width, and duty cycle to duty cycle
Data	Time interval error, unit interval, N Unit Interval, unit interval to unit interval, Data rate, CDR, de-emphasis
Statistics	Displays the current, mean, minimum, maximum, range (max-min), standard deviation, number of measurements value for the displayed automatic measurements
Histograms	
Source	Waveform or measurement
Orientation	Vertical (for timing and jitter measurements) or horizontal (noise and amplitude change) modes, regions are defined using waveform markers
Measurements (available as a function)	Mean, standard deviation, mean \pm 1, 2, and 3 sigma, median, mode, peak-to-peak, min, max, total hits, peak (area of most hits), X scale hits, and X offset hits
Mask testing	Allows pass/fail testing to user-defined or Keysight-supplied waveform templates. Automask lets you create a mask template from a captured waveform and define a tolerance range in time/voltage or screen divisions. Test modes (run until) include test forever, test to specified time or event limit, and stop on failure. Executes “multipurpose” user setting on failure. “Unfold real time eye” feature will allow individual bit errors to be observed by unfolding a real time eye when clock recovery is on. Communications mask test kit option provides a set of ITU-T G.703, ANSI T1.102, and IEEE 802.3 industry-standard masks for compliance testing.
Waveform math	
Number of functions	Sixteen
Hardware accelerated math operations	Differential and Common mode Absolute value, add, amplitude demodulation (radar envelope), average, Butterworth*, common mode, delay, differentiate, divide, FFT magnitude, FFT, phase, FIR*, high pass filter, histogram, horizontal gating, integrate, invert, LFE*, low pass filter (4th-order Bessel Thompson filter), magnify, max, measurement trend, min, multiply, RT Eye*, smoothing, SqrtSumOfSquare*, square, square root, subtract, versus, and optional user-defined function (Option 010)
FFT	
Frequency range	DC to 80 GHz (at 160 GSa/s) or 40 GHz (at 80 GSa/s) or 20 GHz (at 40 GSa/s)
Frequency resolution	Sample rate/memory depth = resolution
Window modes	Hanning, flattop, rectangular, Blackman-Harris, Hamming

1. Requires MATLAB (Option N8831A) software.

Specifications (Continued)

Hardware trigger (Continued)	
Measurement modes	
Automatic measurements	Measure menu access to all measurements, up to ten measurements can be displayed simultaneously
Multipurpose	Front-panel button activates up to ten pre-selected or up to ten user-defined automatic measurements
Drag-and-drop measurement toolbar	Measurement toolbar with common measurement icons that can be dragged and dropped onto the displayed waveforms
Marker modes	
	Manual markers, track waveform data, track measurements
Display	
Display	15.4-inch color XGA TFT-LCD with touch screen
Intensity grayscale	256-level intensity-graded display
Resolution XGA	1024 pixels horizontally x 768 pixels vertically
Annotation	Up to 12 labels, with up to 100 characters each, can be inserted into the waveform area
Grids	Choose 1, 2, 4, 8, or 16 grids, each with 8 bit vertical resolution
Waveform styles	Connected dots, dots, infinite persistence, color graded infinite persistence. Includes up to 256 levels of intensity-graded waveforms., variable persistence
Waveform update rate	
Maximum update rate	> 400,000 waveforms per second (when in the segment memory mode)
Computer system and peripherals, I/O ports	
Computer system and peripherals	
Operating system	
CPU	Windows Seven
PC system memory	Intel Core 2 Duo 3.06 GHz
Drives (SSD)	4GB DDR2
Peripherals	≥ 250-GB internal hard drive removable hard drive, additional hard drives (N2746A) Optional USB external DVD-RW drive (Option 820) Logitech optical USB mouse, compact USB keyboard and stylus supplied. All Infiniium models support any Windows-compatible input device with a serial, PS/2 or USB interface
File types	
Waveforms	Compressed internal format (*.wfm (200 Mpts)), comma-separated values (*.csv (2 Gpts)), tab separated values (*.tsv (2 Gpts)), public binary format (.bin (500 Mpts)), Y value files (*.txt (2 Gpts)), hierarchal data file (*.hf5 (2 Gpts))
Images	BMP, PNG, TIFF, GIF, JPEG, or osc file format
I/O ports	
	RS-232 (serial), parallel, PS/2, USB 2.0 hi-speed (host), USB 2.0 hi-speed (device), dual-monitor video output, auxiliary output, trigger output, time base reference output
General characteristics	
Temperature	Operating: 5 °C to + 40 °C; Non-operating: -40°C to +65 °C
Humidity	Operating: Up to 95% relative humidity (non-condensing) at +40 °C; Non-operating: Up to 90% relative humidity at +65 °C
Altitude	Operating: Up to 4,000 meters (12,000 feet); Non-operating: Up to 15,300 meters (50,000 feet)
Vibration	
	Operating random: 00.21 g(rms)
	Non-operating random: 2.0 g(rms)
	Swept sines: (0.50 g)
Power	
	100 to 240 VAC ± 10% at 50/60 Hz
	Maximum input power 1350 W
	Typical input power 1200 W
	Well regulated power is required for 100 to 120 VAC operation
Weight	32.2 kg (71 lbs)
Dimensions	Height: 33.8 cm (13.3 in); Width: 50.8 cm (20 in); Depth: 49.3 cm (19.4 in)
Safety	Meets IEC 61010-1 +A2, CSA certified to C22.2 No.1010.1, self-certified to UL 3111

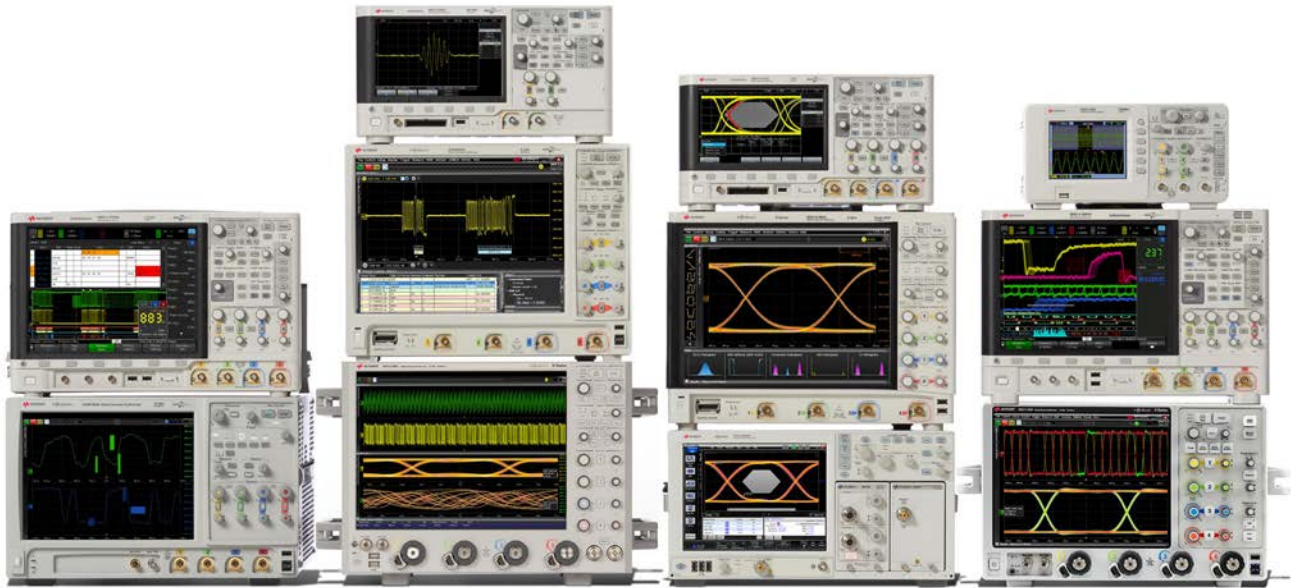

Keysight Oscilloscopes

Multiple form factors from 20 MHz to > 90 GHz | Industry leading specs | Powerful applications

Learn more at: www.keysight.com

For more information on Keysight Technologies' products, applications or services, please contact your local Keysight office. The complete list is available at: www.keysight.com/find/contactus

