Keysight M937xA PXIe Vector Network Analyzer Modules - Startup Guide

This is the Startup Guide for the M937xA PXIe Vector Network Analyzer Modules.

Notices

© Keysight Technologies, Inc.
2014-2022

No part of this manual may be reproduced in any form or by any means (including electronic storage and retrieval or translation into a foreign language) without prior agreement and written consent from Keysight Technologies, Inc. as governed by United States and international copyright laws.

Trademark Acknowledgments

Manual Part Number

M9370-90001

Edition

Edition 2, August 2022

Printed in USA/Malaysia

Published by:

Keysight Technologies
1400 Fountaingrove Parkway
Santa Rosa, CA 95403

Warranty

THE MATERIAL CONTAINED IN THIS DOCUMENT IS PROVIDED "AS IS," AND IS SUBJECT TO BEING CHANGED, WITHOUT NOTICE, IN FUTURE EDITIONS. FURTHER, TO THE MAXIMUM EXTENT PERMITTED BY APPLICABLE LAW, KEYSIGHT DISCLAIMS ALL WARRANTIES, EITHER EXPRESS OR IMPLIED WITH REGARD TO THIS MANUAL AND ANY INFORMATION CONTAINED HEREIN, INCLUDING BUT NOT LIMITED TO THE IMPLIED WARRANTIES OF MERCHANTABILITY AND FITNESS FOR A PARTICULAR PURPOSE. KEYSIGHT SHALL NOT BE LIABLE FOR ERRORS OR FOR INCIDENTAL OR CONSEQUENTIAL DAMAGES IN CONNECTION WITH THE FURNISHING, USE, OR PERFORMANCE OF THIS DOCUMENT OR ANY INFORMATION CONTAINED HEREIN. SHOULD KEYSIGHT AND THE USER HAVE A SEPARATE WRITTEN AGREEMENT WITH WARRANTY TERMS COVERING THE MATERIAL IN THIS

DOCUMENT THAT CONFLICT WITH THESE TERMS, THE WARRANTY TERMS IN THE SEPARATE AGREEMENT WILL CONTROL.

Technology Licenses

The hardware and/or software described in this document are furnished under a license and may be used or copied only in accordance with the terms of such license.

U.S. Government Rights

The Software is "commercial computer software," as defined by Federal Acquisition Regulation ("FAR") 2.101. Pursuant to FAR 12.212 and 27.405-3 and Department of Defense FAR Supplement ("DFARS") 227.7202, the U.S. government acquires commercial computer software under the same terms by which the software is customarily provided to the public.

Accordingly, Keysight provides the Software to U.S. government customers under its standard commercial license, which is embodied in its End User License Agreement (EULA), a copy of which can be found at

<http://www.keysight.com/find/sweula>

The license set forth in the EULA represents the exclusive authority by which the U.S. government may use, modify, distribute, or disclose the Software. The EULA and the license set forth therein, does not require or permit, among other things, that Keysight: (1) Furnish technical information related to commercial computer software or commercial computer software documentation that is not customarily provided to the public; or (2) Relinquish to, or otherwise provide, the government rights in excess of these rights customarily provided to the public to use, modify, reproduce, release, perform, display, or disclose commercial computer software or commercial computer software documentation. No additional

government requirements beyond those set forth in the EULA shall apply, except to the extent that those terms, rights, or licenses are explicitly required from all providers of commercial computer software pursuant to the FAR and the DFARS and are set forth specifically in writing elsewhere in the EULA. Keysight shall be under no obligation to update, revise or otherwise modify the Software. With respect to any technical data as defined by FAR 2.101, pursuant to FAR 12.211 and 27.404.2 and DFARS 227.7102, the U.S. government acquires no greater than Limited Rights as defined in FAR 27.401 or DFAR 227.7103-5 (c), as applicable in any technical data.

Safety Notices

CAUTION

A **CAUTION** notice denotes a hazard. It calls attention to an operating procedure, practice, or the like that, if not correctly performed or adhered to, could result in damage to the product or loss of important data. Do not proceed beyond a CAUTION notice until the indicated conditions are fully understood and met.

WARNING

A **WARNING** notice denotes a hazard. It calls attention to an operating procedure, practice, or the like that, if not correctly performed or adhered to, could result in personal injury or death. Do not proceed beyond a WARNING notice until the indicated conditions are fully understood and met.

1Getting Started	
	Introduction	5
	Related Documentation	5
	STEP 1. Unpack and Inspect the Network Analyzer Modules	5
	Inspect for Damage	6
	How to Return an Instrument for Service	7
	STEP 2. Check the Shipment	7
	STEP 3. Install the Software	8
	System Requirements	8
	Hardware Requirements	9
	Power Up the Controller	10
	Software Installation Overview	10
	STEP 4. Install the Network Analyzer Modules	12
	Recommended Best Practices to Ensure Proper and Safe Module Operating Conditions	12
	Tools Required for the Installation Procedure	13
	Installation Procedure	13
	Front Panel Features	20
	STEP 5. Verify Operation of the Network Analyzer Modules	21
	The Operator's Check	21
	If the Operator's Check Fails	22
2 Getting Help with Your Network Analyzer Module	
	Help System	23
	N937xA on the Internet	23
	Contacting Keysight	24
3 Safety and Regulatory Information	
	Maintenance	25
	Shipment for Service	25
	Safety Symbols	26
	General Safety Considerations	27
	Before Applying Power	27
	Servicing	27
	Operating Conditions	27
	Regulatory Information	28
	Instructions for Use	28

Contents

EMC	28
Safety	28
Instrument Markings	29
Declaration of Conformity	31
Warranty	31

1 Getting Started

Introduction

The purpose of this Startup Guide is to detail the processes of receiving and installing the network analyzer module and cables that compose the Keysight M937xA PXIe Vector Network Analyzer module. Additionally, installing the required software and verifying network analyzer module operation is documented. If you have any questions after reviewing this information, please contact your local Keysight Technologies Inc. representative or contact us through our support Website at <http://www.keysight.com/technicalsupport/main>.

Related Documentation

You can find all M937xA PXI network analyzer module documentation and other resources at:
<https://www.keysight.com/us/en/products/signal-generators-signal-sources/pxi-signal-generators.html>
or at the respective product pages on www.keysight.com (go to Document Library > Manuals).

STEP 1. Unpack and Inspect the Network Analyzer Modules

CAUTION

The network analyzer modules are shipped in materials which prevent damage from static. The modules should only be removed from the packaging in an anti-static area ensuring that correct anti-static precautions are taken. Store all modules in anti-static envelopes when not in use.

Electrostatic discharge (ESD) can damage or destroy electronic components. Use a static-safe work station to perform all work on electronic assemblies. **Figure 1-1 on page 6** shows a static-safe work station using two types of ESD protection: conductive table-mat and wrist-strap combination, and conductive floor-mat and heel-strap combination. Both types, when used together, provide a significant level of ESD protection. Of the two, only the table-mat and

Getting Started

STEP 1. Unpack and Inspect the Network Analyzer Modules

wrist-strap combination provides adequate ESD protection when used alone. To ensure user safety, the static-safe accessories must provide at least 1 meg-ohm of isolation from ground.

WARNING

Do NOT use these techniques for a static-safe work station when working on circuitry with a voltage potential greater than 500 volts.

Figure 1-1

ESD protection setup

ESD

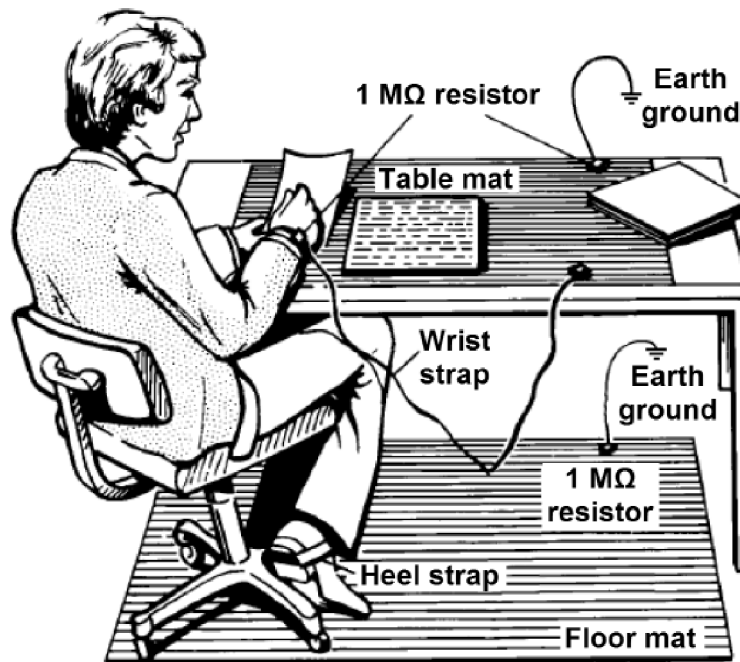

M9370_001_101

Unpack the network analyzer modules from the shipping containers. Keep the black and red plastic port protectors and the shipping containers for possible reuse.

Inspect for Damage

After unpacking a network analyzer module, inspect it for any shipping damage. Report any damage to the shipping agent immediately, as such damage is not covered by the warranty.

CAUTION

To avoid damage when handling the network analyzer modules, do not touch exposed connector pins.

How to Return an Instrument for Service

Should it become necessary to return a network analyzer module for repair or service, follow the steps below:

1. Review the warranty information shipped with your product.
2. Contact Keysight to obtain a Return Material Authorization (RMA) and return address. For assistance finding Keysight contact information, go to www.keysight.com/find/assist (worldwide contact information for repair and service).
3. Write the following information on a tag and attach it to the network analyzer module:
 - Name and address of owner. A P.O. box is not acceptable as a return address.
 - Network analyzer module serial numbers. The serial number label is located on the side panel of the module. The serial number can also be read from the Soft Front Panel (SFP) interface, after the hardware is installed.
 - Description of the service required or the failure.
4. On the shipping label, write ATTENTION REPAIR DEPARTMENT and the RMA number.
5. Ship the analyzer module using the original packaging materials. Shipping the analyzer module in anything other than the original packaging may result in non-warranted damage.

NOTE

In your correspondence, refer to the network analyzer module by serial number and by model number.

STEP 2. Check the Shipment

Use the Contents List in the shipping container to verify the completeness of your shipment. If not complete, refer to **“Contacting Keysight” on page 24.**

STEP 3. Install the Software

System Requirements

Topic	Windows 7 and Vista Requirements
Operating system	Windows 7 (32 bit and 64 bit) Windows Vista, SP 1 and SP2 (32-bit and 64-bit)
Processor speed	1.5 GHz dual core (x86 or x64) minimum (2.4 GHz recommended)
Available memory	1 GB minimum (8 GB recommended)
Available disk space	1.5 GB available hard disk space

Hardware Requirements

Topic	Requirements
Chassis	PXIe or PXI-H chassis slot
Controllers	PXI or PXI Express embedded controller or remote controller (external PC connected to the chassis by a PCI-to-PXI interface) is required.
Embedded controller	Keysight M903xA or an equivalent embedded controller that meets the following requirements: <ul style="list-style-type: none">– A PXIe system controller (PXI-1 embedded controllers are not compatible).– Utilizes a 2x8, 4x4, or 1x8 PXIe system slot link configuration.– Runs one of the operating systems listed in "System Requirements" on page 8 (above).
Remote controller	(For Keysight M9018A chassis use only) A PC running one of the operating systems listed in " System Requirements " on page 8 and a Keysight M9021A Cable Interface x8 with one of the following PC interface options: <ul style="list-style-type: none">– Keysight M9045B PCIe ExpressCard Adapter x1, with cable (for a laptop PC)– Keysight M9048B PCIe Desktop Adapter x8, with cable (for a desktop PC)
Optional	
Y1281A Kit	Contains: Socket adapter (p/n 5023-1450 and Cable removal tool (p/n 5002-3361). To order, refer to " Contacting Keysight " on page 24.

Power Up the Controller

If you are using a remote controller, complete the following steps:

1. Install the cable interface between the remote controller and the chassis. If you are using an Keysight M9021A cable interface, refer to the Keysight M9021A documentation for further details.
2. Power up the chassis.
3. Power up the PC.

CAUTION

If you are using a remote controller and you have installed the interface cable, you must power up the chassis **BEFORE** you power up the PC.

When you power down your system, shut down the PC **BEFORE** you power down the chassis.

If you are using an embedded controller, complete the following steps:

1. Install the embedded controller module into a compatible chassis. The Keysight M9018A PXIe chassis is recommended. Refer to the Keysight M9018A documentation for further details.
2. Connect peripherals (mouse, keyboard, monitor).
3. Power up the chassis.

Software Installation Overview

The software installation includes the following items:

- Keysight IO Libraries Suite (IOLS), which includes the Keysight Connection Expert. Download the latest version at www.keysight.com/find/iosuite. This software must be installed first.

NOTE

Version 16.3.6603.3 (or newer) of the Keysight IO Libraries Suite is required.

- Network analyzer module software, which includes the soft front panel (SFP) software, device drivers (IVI-C and IVI-COM, and LabVIEW G), and documentation for the M937xA PXIe Vector Network Analyzer modules. Download the latest version at <http://www.keysight.com/technicalsupport/main>. Enter the model for your instrument and click **Find**.

Software Installation Procedure

1. Install the Keysight IO Libraries Suite by downloading it from www.keysight.com/find/iosuite. Follow the installer prompts to install the IO libraries.
2. Install the network analyzer module software by downloading it from <http://www.keysight.com/technicalsupport/main>. Enter the model for your instrument and click **Find**. Follow the installer prompts.
3. Complete the installation:

If Using an Embedded Controller:

- a. After the InstallShield Wizard has completed, click Finish.
- b. Restart the embedded controller PC, using Start > Restart, and wait for the system to restart.

If Using a Remote Controller:

- a. After the InstallShield Wizard has completed, click Finish.
- b. Shut down the remote controller PC, using Start > Shut down.
- c. Power down the chassis.
- d. Power up the chassis.
- e. Power up the remote controller PC.

NOTE

Check for software updates at:
<http://www.keysight.com/technicalsupport/main>. Enter the model for your instrument and click **Find**. Follow the installer prompts.

STEP 4. Install the Network Analyzer Modules

NOTE

Please review all safety information located in **Chapter 3** before proceeding with installing and using the network analyzer module.

NOTE

These modules can be used in a chassis with a PXIe, or PXI-H chassis slots.

Recommended Best Practices to Ensure Proper and Safe Module Operating Conditions

- Ensure proper chassis air flow is maintained.
- The use of a Keysight M9018A chassis is recommended for optimum temperature control. If a different chassis is used, make sure it provides thermal protection if fans become inoperable or forced air cooling is obstructed.
 - If using the Keysight M9018A PCIe Cable Interface, download the *Keysight Multiple PXIe and AXIe Chassis System Configuration Tool*. Save the file to your local hard drive; do not try to open the file from the Internet location.
- Use slot blockers and EMC filler panels in empty module slots to ensure proper operating temperatures. Keysight chassis and slot blockers optimize module temperature performance and reliability of test.
- Set chassis fans to high or auto. Do not disable fans.
- Position chassis to allow plenty of space around chassis air intake and fan exhaust.
- At ambient temperatures above 45° C (113° F) set the chassis fan to high.

Figure 1-2 M937xA chassis air flow

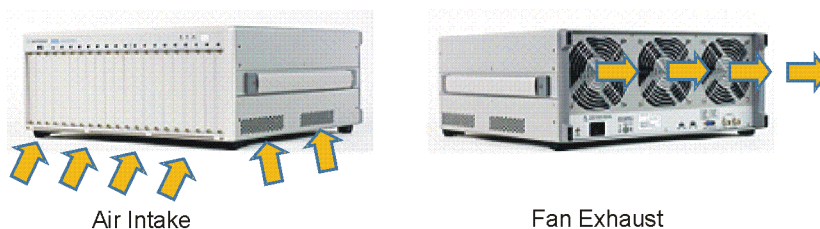

The M9018A has multiple air intakes located on the lower sides, lower front and bottom front of chassis.
Fan exhausts through the rear of the chassis

M9370_001_109

Tools Required for the Installation Procedure

- Phillips #1 torque driver, set to 4 in-lbs (0.45 N.m) - not supplied.
- Socket adapter (part number 5023-1450) - not supplied.¹
- Torque driver (for use with socket adapter), set to 8 in-lb (0.91 N.m) - not supplied.
- Cable removal tool (part number 5002-3361) - not supplied¹.

Installation Procedure

CAUTION

PXI hardware does not support “hot-swap” (changing network analyzer modules while power is applied to the chassis) capabilities. Before installing or removing a module to/from the chassis, power-off the chassis to prevent damage to the module.



The network analyzer module can be installed in any PXIe or hybrid PXI slot marked with a peripheral slot compatibility image (solid black circle for PXIe, or solid black circle with the letter “H” for hybrid).

1. Make sure that the line cord is plugged in to establish earth ground and that the chassis power switch is Off (see callouts 1 and 3 in [Figure 1-3 on page 14](#)).
2. Wear a grounded wrist strap for this procedure (see callout 2 in [Figure 1-3 on page 14](#)).
3. If the chassis has multiple fan speed settings, ensure that the fan switch is set to AUTO.
4. Position the chassis to provide ample space between the chassis fan intake and exhaust vents. Blockage by walls or obstructions affects the air flow needed for cooling. (Refer to the chassis documentation for more information about cooling.)
5. Before inserting the network analyzer module into the chassis, back-out the top mounting screw (see callout 7 in [Figure 1-3 on page 14](#)) on the module to ensure that there is no interference between the screws and the mounting rails.

1. The socket adapter (p/n 5023-1450) and Cable removal tool (p/n 5002-3361) are part of the Y1281A kit. Refer to, "[Hardware Requirements](#)" on page 9 and to "[Contacting Keysight](#)" on page 24.

6. Holding the module by the injector/ejector handle, slide it into a slot, as shown in callouts 4 – 6 in **Figure 1-3 on page 14**.
 - a. Install the module into the slot of the chassis by placing the module card edges into the front module guides (top and bottom).
 - b. Hold down the silver locking tab while pushing down the injector/ejector handle to the unlatched (downward) position, and slide the module to the rear of the chassis.
 - c. Slide the module completely into the chassis. When you begin to feel resistance, pull up on the injector/ejector handle to fully inject the module into the chassis. The injector/ejector handle should lock into place. (To remove the module from the chassis, you must first press the injector/ejector handle to unlock it.)

Figure 1-3 Installing the Network Analyzer Module

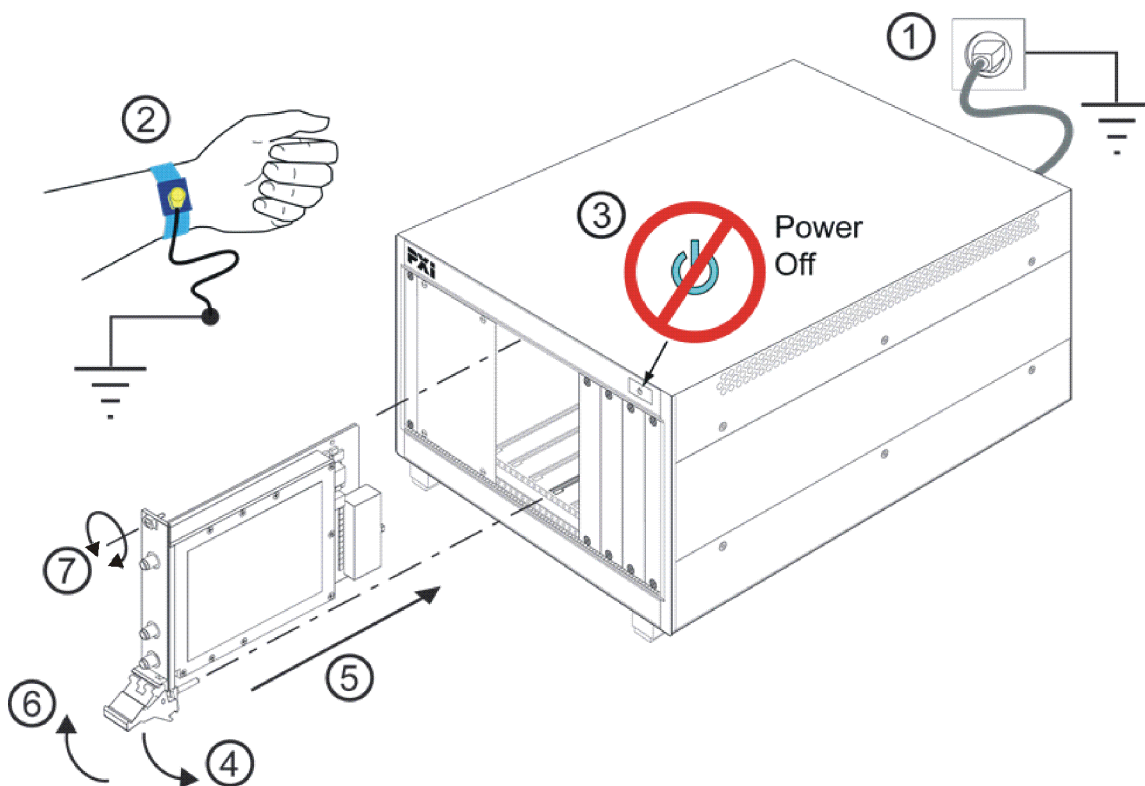

M9370_001_201

7. Repeat for other modules, if present.
8. Tighten the top mounting screw (see callout 7 in **Figure 1-3**) and the bottom mounting screw (located below the injector/ejector handle) on the module(s) using a Phillips #1 torque drive set to 4 in-lbs (0.45 N.m).
9. Install EMC filler panels and slot blockers into empty module slots to assure proper air circulation and operating temperatures.

10. If using only one M937xA module in the chassis, leave the 50 ohm loads attached as shown in [Figure 1-4 on page 15](#).

Figure 1-4 Single M937xA Network Analyzer Module Configuration



M9370_001_106

NOTE

In the following instructions, eight network analyzer modules are configured. Use these instructions as a general guide if installing a different number of modules.

11. As seen in [Figure 1-5 on page 16](#), each module is shipped with two 50 ohm loads attached to each module. To enable connections between module pairs, some of these loads must be removed. To remove the loads, use the socket adapter, seen in [Figure 1-6 on page 16](#), attached to the 8 in-lb (0.91 N.m) torque driver.

- a. On the module in slot 1, remove the 50 ohm load from the LO Out port. Leave the load installed on the LO In port.
- b. On the module in slot 8, remove the 50 ohm load from the LO In port. Leave the load installed on the LO Out port.
- c. On each of the remaining modules, remove both 50 ohm loads.
- d. Save the 50 ohm loads that were just removed for possible reuse in another module configuration.

Getting Started
STEP 4. Install the Network Analyzer Modules

Figure 1-5 50 Ohm Loads Installed on the Network Analyzer Modules



M9370_001_102

Figure 1-6 Socket Adapter for 50 Ohm Loads (part number 5023-1450)



M9370_001_107

12. Install a semi-rigid cable (M9370-20018), seen in **“Installing Semi-Rigid Cable M9370-20018”** on page 17, between the Trig Out port and the Trig In port on each of the module pairs (1 & 2, 2 & 3, 3 & 4, 4 & 5, 5 & 6, 6 & 7, and 7 & 8).

Getting Started
STEP 4. Install the Network Analyzer Modules

Figure 1-7 Installing Semi-Rigid Cable M9370-20018



M9370_001_103

NOTE

Use the Y1281A kit cable removal tool (5002-3361) to remove the M9370-20018 cables if necessary. See [Figure 1-8 on page 18](#) and [“Hardware Requirements” on page 9.](#)^a

- a. The socket adapter (p/n 5023-1450) and Cable removal tool (p/n 5002-3361) are part of the Y1281A kit. Refer to, [“Hardware Requirements” on page 9](#) and to [“Contacting Keysight” on page 24](#).

Getting Started
STEP 4. Install the Network Analyzer Modules

Figure 1-8 Cable Removal Tool (part number 5002-3361)¹

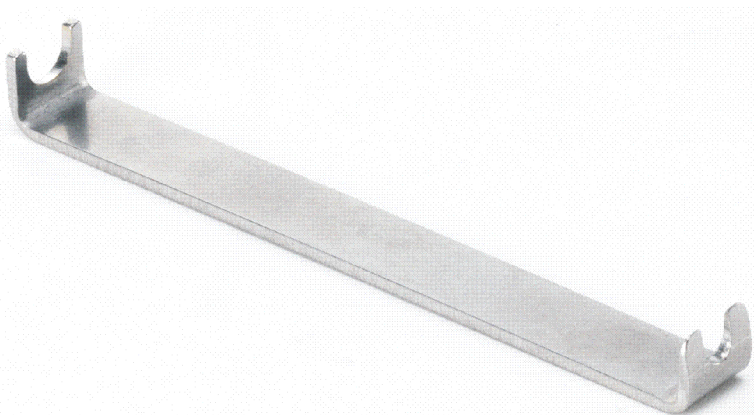

M9370_001_108

13. Install a semi-rigid cable (M9370-20006), seen in **Figure 1-9**, between the LO Out port and the LO In port on each of the module pairs (1 & 2, 2 & 3, 3 & 4, 4 & 5, 5 & 6, 6 & 7, and 7 & 8), hand tightening the connectors.

Figure 1-9 Installing Semi-Rigid Cable M9370-20006

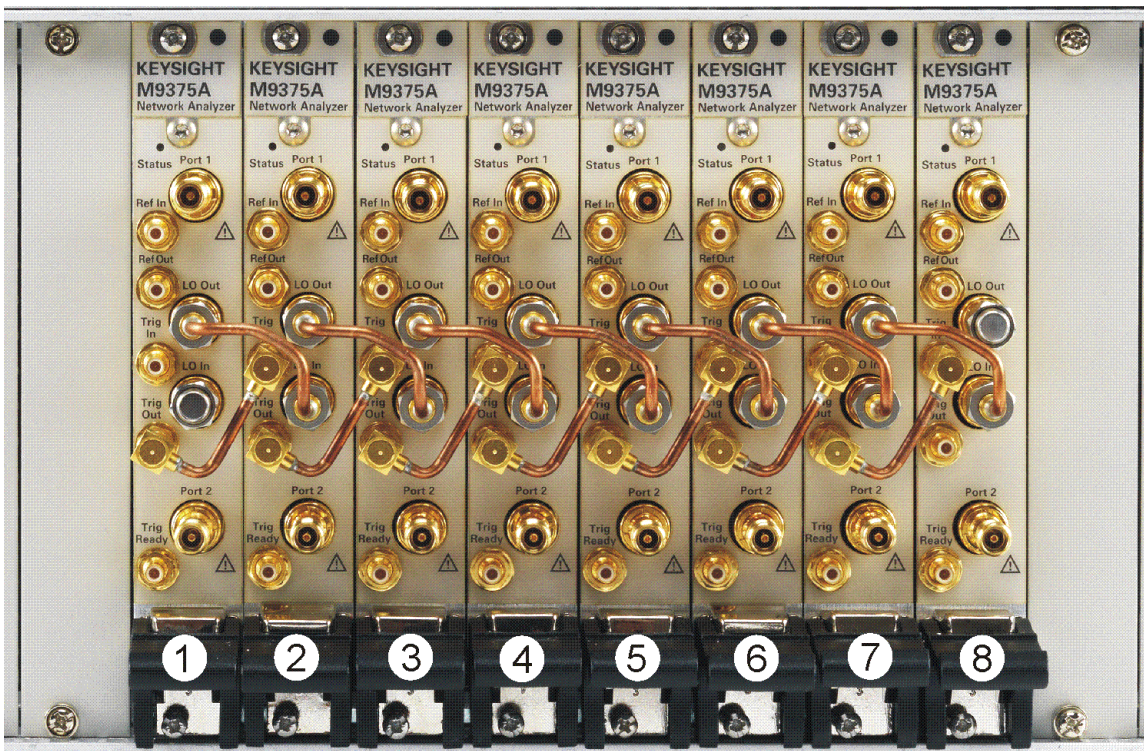

M9370_001_104

1. The socket adapter (p/n 5023-1450) and Cable removal tool (p/n 5002-3361) are part of the Y1281A kit. Refer to, "**Hardware Requirements**" on page 9 and to "**Contacting Keysight**" on page 24.

Getting Started

STEP 4. Install the Network Analyzer Modules

14. Tighten the semi-rigid cable using the socket adapter, seen in [Figure 1-6 on page 16](#), attached to an 8 in-lb (0.91 N.m) torque driver.

15. Install a semi-rigid cable (M9370-20019), seen in [Figure 1-10](#), between the Ref Out port and the Ref In port on each of the module pairs (1 & 2, 2 & 3, 3 & 4, 4 & 5, 5 & 6, 6 & 7, and 7 & 8).

Figure 1-10 Installing Semi-Rigid Cable M9370-20019

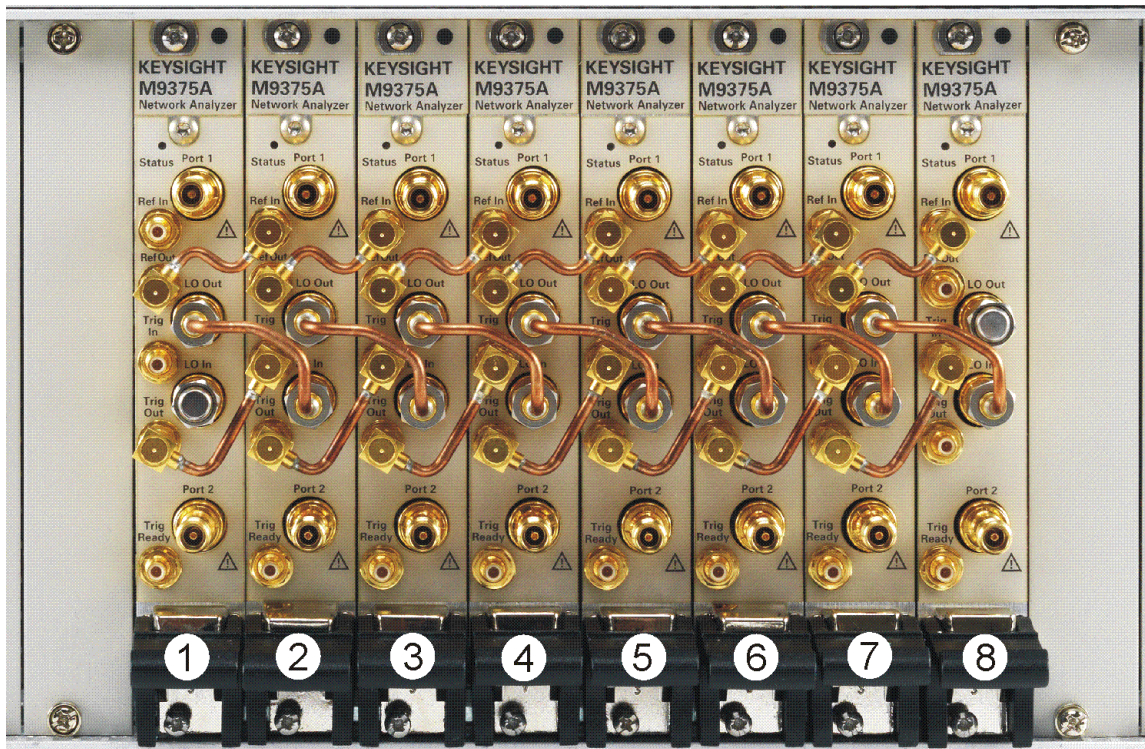

M9370_001_105

NOTE

Use the supplied cable removal tool (5002-3361) to remove the M9370-20019 cables if necessary. See [Figure 1-8 on page 18](#).^a

- a. The socket adapter (p/n 5023-1450) and Cable removal tool (p/n 5002-3361) are part of the Y1281A kit. Refer to, "[Hardware Requirements](#)" on [page 9](#) and to "[Contacting Keysight](#)" on [page 24](#).

You have now completed the hardware installation procedure.

Front Panel Features

Front Panel Photo	Feature	Description
	Status LED	<p>OFF: Power supply off. Safe to remove the network analyzer module from the chassis.</p> <p>AMBER: Power supply on, but no firmware is in control.</p> <p>GREEN: Firmware is in control; instrument is probably idle.</p> <p>FLASHING GREEN: A sweep or measurement has been triggered.</p> <p>RED: Last sweep had an error.</p>
	Port 1	<p>APC 3.5 mm female connector. Sources stimulus signals for the DUT and receives response signals from the DUT. Frequency range is determined by the network analyzer module model.</p>
	Port 2	
	LO In	<p>SMA female connector. If the network analyzer module is not configured with another module, the connector is terminated with a 50 ohm load. If the module is configured with a module in an adjacent slot, the connector receives the LO signal from the configured module.</p>
	LO Out	<p>SMA female connector. If the network analyzer module is not configured with another module, the connector is terminated with a 50 ohm load. If the analyzer module is configured with a module in an adjacent slot, the connector provides the LO signal to the configured module.</p>
	Ref In	<p>SMB female connector. A 10 MHz external reference signal supplied to this port can be used as the instrument frequency reference instead of the internal frequency reference. To activate this feature on the soft front panel, select Utility > System > Configure > External Reference.</p>
	Ref Out	<p>SMB female connector. Outputs a 10 MHz frequency reference signal for use by other test equipment.</p>
	Trig In	<p>SMB female connector. Inputs a signal to trigger the network analyzer module.</p>
	Trig Out	<p>SMB female connector. Outputs a signal either before or after a measurement.</p>
	Trig Ready	<p>SMB female connector. Outputs a "READY" signal to other devices.</p>

STEP 5. Verify Operation of the Network Analyzer Modules

The Operator's Check

NOTE

Allow the network analyzer modules to warm up for at least 15 minutes before performing the Operator's Check.

The operator's check is a software driven test that checks the basic operation of the assemblies in all of the measurement port signal paths. By performing the operator's check, the following are determined:

- attenuation ranges of all installed attenuators
- calibration of the receivers
- frequency response of the receivers
- phase lock
- noise floor and trace noise
- various voltages throughout the network analyzer module

Accessories Used in the Operator's Check

Male short(s) or open(s) from a 3.5 mm calibration kit.

Performing the Operator's Check

NOTE

Perform the Operator's Check on each network analyzer module in your configuration.

1. On your PC screen, click the Network Analyzer icon.
2. Select a network analyzer module in your configuration.
3. On the soft front panel, select Utility > System > Service > Operator's Check.
4. In the PXI Operator's Check dialog box (refer to [Figure 1-11 on page 22](#)), under Configure, select either Prompt for attachment of Short/Open, to pause at each step in the process to allow moving the short/open to the appropriate port, or Shorts/Opens are attached to ALL ports, to run through the test without stopping. Shorts and opens can be mixed on the test ports.
5. Select Begin.
6. If shorts and opens are not connected to all ports, you will be prompted to connect them as they are needed.
7. The result of the operator's check will be shown as a PASS or FAIL next to each test (refer to [Figure 1-11 on page 22](#)).

Figure 1-11

Operator's Check Dialog Box

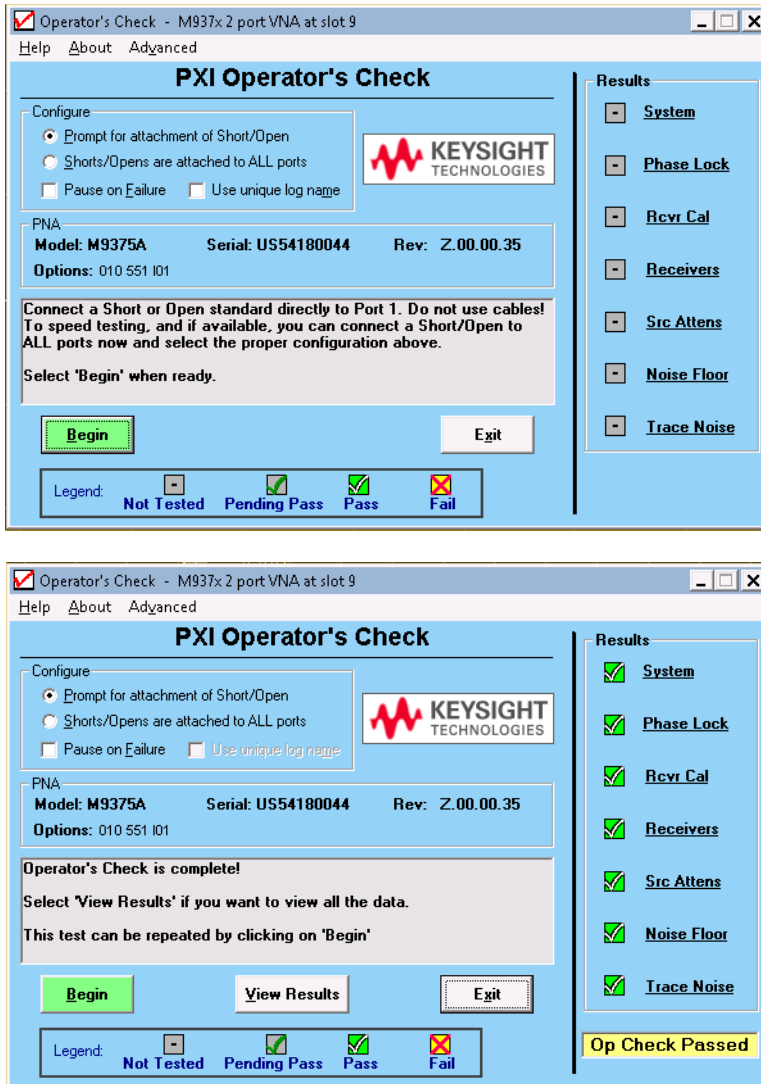

If the Operator's Check Fails

1. Clean the test ports, and the open(s) or short(s). Torque to specification. Repeat the check.
2. If the check still fails, return the network analyzer module to Keysight. See ["How to Return an Instrument for Service" on page 7.](#)

2 Getting Help with Your Network Analyzer Module

Help System

Use the Help System to quickly reference programming and user documentation

To access Help:

- From the analyzer module software
 - On your PC screen, click the Network Analyzer icon.
 - After making your analyzer module configuration settings, click Help.
- Online, go to <http://na.support.keysight.com/pxi/help>.

N937xA on the Internet

The M937xA PXI Network Analyzer System Web page is another resource for help with the analyzer module. You can find all M937xA PXI network analyzer module documentation and other resources at:

<http://na.support.keysight.com/pxi/help>.

Check for software updates at:

<https://www.keysight.com/us/en/products/signal-generators-signal-sources/pxi-signal-generators.html>. Enter the model for your instrument and click

Find

Contacting Keysight

Assistance with test and measurements needs and information on finding a local Keysight office are available on the Web at:

www.keysight.com/find/assist.

If you do not have access to the Internet, please contact your Keysight field engineer.

NOTE

In any correspondence or telephone conversation, refer to the Keysight product by its model number and full serial number. With this information, the Keysight representative can determine whether your product is still within its warranty period.

3 Safety and Regulatory Information

Maintenance

To remove dirt or dust from the external case of the network analyzer module, clean the case using a dry or slightly-dampened cloth only.

WARNING

To prevent electrical shock, remove analyzer module from chassis slot for cleaning. Use a dry cloth or one slightly dampened with water to clean the external case parts. Do not attempt to clean internally.

Shipment for Service

Contact Keysight Technologies for instructions on where to ship the analyzer module for service. Refer to **“Contacting Keysight” on page 24**.

Ship the analyzer module using the original packaging materials. Shipping the analyzer module in anything other than the original packaging may result in non-warranted damage.

Safety Symbols

The following safety symbols are used throughout this manual. Familiarize yourself with each of the symbols and its meaning before operating this instrument.

CAUTION

Denotes a hazard. It calls attention to a procedure that, if not correctly performed or adhered to, would result in damage to or destruction of the product. Do not proceed beyond a caution note until the indicated conditions are fully understood and met.

WARNING

Denotes a hazard. It calls attention to a procedure which, if not correctly performed or adhered to, could result in injury or loss of life. Do not proceed beyond a warning note until the indicated conditions are fully understood and met.

General Safety Considerations

Before Applying Power

WARNING

If this product is not used as specified, the protection provided by the equipment could be impaired. This product must be used in a normal condition (in which all means for protection are intact) only.

CAUTION

The measuring terminals on this instrument are designed to be used with external signals described in Measurement Category I, but NOT with external signals described in Categories II, III, and IV. The input of this instrument cannot be connected to the mains.

Servicing

WARNING

These servicing instructions are for use by qualified personnel only. To avoid electrical shock, do not perform any servicing unless you are qualified to do so.

Operating Conditions

WARNING

Operator is responsible for maintaining safe operating conditions. To ensure safe operating conditions, modules should not be operated beyond the full temperature range documented in the M937xA Data Sheet (<https://www.keysight.com/us/en/assets/9018-03636/technical-specifications/9018-03636.pdf> (M9370-90002)). Not maintaining safe operating conditions can result in shorter module lifespans, improper module performance, and user safety issues. If modules are allowed to exceed the specified full temperature range, module surface temperatures can cause discomfort or burns if touched. If a module exceeds the full temperature range, always allow it to cool before touching it or removing it from the chassis.

Regulatory Information

This section contains information that is required by various government regulatory agencies.

Instructions for Use

This product has been designed and tested in accordance with accepted industry standards, and has been supplied in a safe condition. The documentation contains information and warnings that must be followed by the user to ensure safe operation and to maintain the product in a safe condition.

EMC

Complies with the essential requirements of the European EMC Directive as well as current editions of the following standards (dates and editions are cited in the Declaration of Conformity):

- IEC/EN 61326-1
- CISPR Pub 11 Group 1, class A
- AS/NZS CISPR 11
- ICES/NMB-001
This ISM device complies with Canadian ICES-001.
Cet appareil ISM est conforme a la norme NMB-001 du Canada.

South Korean Class A EMC declaration: This equipment is Class A suitable for professional use and is for use in electromagnetic environments outside of the home.

A 급 기기 (업무용 방송통신기자재) 이 기기는 업무용 (A 급) 전자파적합기
기로서 판 매자 또는 사용자는 이 점을 주의하시기 바라 며 , 가정외의 지역
에서 사용하는 것을 목적으 로 합니

Safety

Acoustic statement (European Machinery Directive)













- Acoustic noise emission
- LpA <70 dB
- Operator position
- Normal operation mode per ISO 7779

Instrument Markings

The table below lists the definitions of markings that may be on or with the product. Familiarize yourself with each marking and its meaning before operating the instrument.



NOTE

Some instrument markings may not appear on your analyzer.

	This symbol marks the standby position of the power line switch.
	This symbol marks the ON position of the power line switch.
	This symbol marks the OFF position of the power line switch.
	This symbol indicates that the input power required is AC.
	This symbol indicates DC voltage
	This symbol indicates a three-phase alternating current.
	This symbol indicates Frame or chassis Terminal.
	The instruction documentation symbol. The product is marked with this symbol when it is necessary for the user to refer to the instruction in the documentation.
	This symbol indicate the presence of a Laser device.
	This symbol indicates the surface can be hot.
	This symbol indicated the product is sensitive to electrostatic discharge.
	This symbol identifies the Protective Conductor terminal.

Safety and Regulatory Information
Regulatory Information

	This symbol indicates the equipment is protected throughout by double or reinforced insulation.
	The CE mark is a registered trademark of the European Community (if accompanied by a year, it is the year when the design was proven). It indicates that the product complies with all the relevant directives.
	The UK conformity mark is a UK government owned mark. Products showing this mark comply with all applicable UK regulations.
	The Keysight email address is required by EU directives applicable to our product.
	The CSA mark is a registered trademark of the CSA International.
	Two person lift required.
CAN ICES/NMB-001(A)	Canada EMC label. Interference-Causing Equipment Standard for industrial, scientific and medical (ISM) equipment. Matériel industriel, scientifique et médical (ISM).
	CE/ICES/ISM label. (Old mark for reference only.) This is a space saver label that combines three markings - CE with CAN ICES and ISM (see above) and ISM (see below).
	This is a space saver label that combines three markings - CE with CAN ICES and ISM (see above) and ISM (see below).
	The RCM mark is a registered trademark of the Australian Communications and Media Authority.
	This is a space saver label that combines two markings - CAN ICES and ISM.
ISM 1-A	This is a symbol of an Industrial Scientific and Medical Group 1 Class A product (CISPR 11, Clause 5).
	South Korean Certification (KC) mark. It includes the marking's identifier code.

	<p>The crossed-out wheeled bin symbol indicates that separate collection for waste electric and electronic equipment (WEEE) is required, as obligated by the EU DIRECTIVE and other National legislation.</p> <p>Please refer to www.keysight.com/go/takeback to understand your trade-in options with Keysight, in addition to product takeback instructions.</p>
	<p>China Restricted Substance Product Label. The EPUP (environmental protection use period) number in the center indicates the time period during which no hazardous or toxic substances or elements are expected to leak or deteriorate during normal use and generally reflects the expected useful life of the product.</p>
	<p>Universal recycling symbol. This symbol indicates compliance with the China standard GB 18455-2001 as required by the China RoHS regulations for paper/fiberboard packaging.</p>
IP x y	<p>This mark indicates product has been designed to meet the requirements of "IP x y", where "x" is the solid particle protection and "y" is the liquid ingress protection.</p>

Declaration of Conformity

A declaration of conformity is available upon request, or a copy is available on the Keysight Technologies Web site at <http://www.keysight.com/go/conformity> or by contacting Keysight - see **"Contacting Keysight" on page 24.**

Warranty

The actual warranty on your instrument depends on the date it was ordered as well as whether or not any warranty options were purchased at that time. To determine the exact warranty on your instrument, contact Keysight Technologies with the model and serial number of your instrument. Refer to **"Contacting Keysight" on page 24.**

Keysight Technologies does not warrant third-party system-level (combination of chassis, controllers, modules, etc.) performance, safety, or regulatory compliance, unless specifically stated.

Safety and Regulatory Information
Warranty

This information is subject to change without notice.
© Keysight Technologies 2014 – 2022
Edition 2, August 2022
Printed in USA/Malaysia



M9370-90001