



**HEWLETT
PACKARD**

INSTALLATION AND VERIFICATION MANUAL

HP 70700A DIGITIZER

SERIAL NUMBERS

This manual applies directly to HP 70700A
Digitizers with serial numbers prefixed 2709A and
below.

FIRMWARE VERSIONS

This manual applies directly to HP 70700A
Digitizers with firmware versions of 870501 and
earlier.

**COPYRIGHT © 1989 HEWLETT-PACKARD COMPANY
1212 VALLEY HOUSE DRIVE, ROHNERT PARK, CALIFORNIA 94928-4999, USA**

**Manual Part Number: 70700-90001
Microfiche Part Number: 70700-90002**

Printed: May 1987

CERTIFICATION

Hewlett-Packard Company certifies that this product met its published specifications at the time of shipment from the factory. Hewlett-Packard further certifies that its calibration measurements are traceable to the United States National Institute of Standards and Technology, to the extent allowed by the Institute's calibration facility, and to the calibration facilities of other International Standards Organization members.

WARRANTY

This Hewlett-Packard instrument product is warranted against defects in material and workmanship for a period of one year from date of shipment. During the warranty period, Hewlett-Packard Company will, at its option, either repair or replace products which prove to be defective.

For warranty service or repair, this product must be returned to a service facility designated by HP. Buyer shall prepay shipping charges to HP and HP shall pay shipping charges to return the product to Buyer. However, Buyer shall pay all shipping charges, duties, and taxes for products returned to HP from another country.

HP warrants that its software and firmware designated by HP for use with an instrument will execute its programming instructions when properly installed on that instrument. HP does not warrant that the operation of the instrument, or software, or firmware will be uninterrupted or error-free.

LIMITATION OF WARRANTY

The foregoing warranty shall not apply to defects resulting from improper or inadequate maintenance by Buyer, Buyer-supplied software or interfacing, unauthorized modification or misuse, operation outside of the environmental specifications for the product, or improper site preparation or maintenance.

NO OTHER WARRANTY IS EXPRESSED OR IMPLIED. HP SPECIFICALLY DISCLAIMS THE IMPLIED WARRANTIES OF MERCHANTABILITY AND FITNESS FOR A PARTICULAR PURPOSE.

EXCLUSIVE REMEDIES

THE REMEDIES PROVIDED HEREIN ARE BUYER'S SOLE AND EXCLUSIVE REMEDIES. HP SHALL NOT BE LIABLE FOR ANY DIRECT, INDIRECT, SPECIAL, INCIDENTAL, OR CONSEQUENTIAL DAMAGES, WHETHER BASED ON CONTRACT, TORT, OR ANY OTHER LEGAL THEORY.

ASSISTANCE

Product maintenance agreements and other customer assistance agreements are available for Hewlett-Packard products.

For any assistance, contact your nearest Hewlett-Packard Sales and Service Office.

SAFETY SYMBOLS

The following safety symbols are used throughout this manual and in the instrument. Familiarize yourself with each of the symbols and its meaning before operating this instrument.



Instruction manual symbol. The instrument will be marked with this symbol when it is necessary for the user to refer to the instruction manual in order to protect the instrument against damage. Location of pertinent information within the manual is indicated by use of this symbol in the table of contents.



Indicates dangerous voltages are present. Be extremely careful.

CAUTION

The CAUTION sign denotes a hazard. It calls attention to a procedure which, if not correctly performed or adhered to, could result in damage to or destruction of the instrument. Do not proceed beyond a CAUTION sign until the indicated conditions are fully understood and met.

WARNING

The WARNING sign denotes a hazard. It calls attention to a procedure which, if not correctly performed or adhered to, could result in injury or loss of life. Do not proceed beyond a WARNING sign until the indicated conditions are fully understood and met.

GENERAL SAFETY CONSIDERATIONS

WARNING

BEFORE THIS INSTRUMENT IS SWITCHED ON, make sure it has been properly grounded through the protective conductor of the ac power cable to a socket outlet provided with protective earth contact. Any interruption of the protective (grounding) conductor, inside or outside the instrument, or disconnection of the protective earth terminal can result in personal injury.

WARNING

There are voltages at many points in the instrument which can, if contacted, cause personal injury. Be extremely careful. Any adjustments or service procedures that require operation of the instrument with protective covers removed should be performed only by trained service personnel.

CAUTION

BEFORE THIS INSTRUMENT IS SWITCHED ON, make sure its primary power circuitry has been adapted to the voltage of the ac power source. Failure to set the ac power input to the correct voltage could cause damage to the instrument when the ac power cable is plugged in.

CONTENTS

Chapter 1. General Information	1-1
Introduction	1-1
Safety	1-1
Printing Conventions	1-2
Software Media	1-2
Description of the HP 70700A Digitizer	1-3
Front Panel	1-3
Rear Panel	1-5
Software/Firmware Compatibility	1-7
HP 70700A Verification Software	1-7
Display Firmware	1-7
HP 70700A Digitizer Firmware	1-8
HP 70900A Local Oscillator Firmware	1-8
Options	1-10
W30 Service Option	1-10
Module/Instrument Options	1-10
Accessories	1-12
Rear Fan Filter	1-12
Display Screen Cleaner	1-12
Probes	1-12
Operating Requirements	1-14
Physical Requirements	1-14
Power Requirements	1-14
Initial Inspection and Setup	1-18
Inspection	1-18
Front Handle Removal and Replacement	1-18
Rack-Mounting	1-20
Rack-Mounting with Slides	1-20
Connecting Instrument Cabinets	1-20
Packaging	1-22
Electrostatic Discharge Information	1-25
Reducing Damage Caused by ESD	1-25
Static-Safe Accessories	1-26
Chapter 2. Installation	2-1
Initial Power-On	2-2
Module Installation and Removal	2-3
Cable Connections and Addressing Examples	2-4
HP-MSIB/HP-IB Addressing	2-11
Modular Measurement System Terms	2-11
Address Matrix	2-12
Address Protocol	2-14
Address Switches	2-15

CONTENTS, Continued

Chapter 3. Specifications	3-1
Specifications versus Characteristics	3-1
Module Specifications	3-2
HP 70700A Digitizer	3-2
HP 70001A Mainframe	3-6
HP 70205A Graphics Display	3-7
HP 70206A System Graphics Display	3-8
System Specifications	3-9
HP 71100A System with HP 70700A As Slave	3-9
HP 71200A, HP 71201A, or HP 71210A Systems with HP 70700A As Slave	3-10
HP 71300A System with HP 70700A As Slave	3-11
Chapter 4. Verification	4-1
Required Test Equipment	4-2
Standard Test Equipment	4-2
Specialized Test Equipment	4-3
Performance Test Software	4-6
Introduction	4-6
Operation	4-7
Measurement Uncertainty	4-14
Installation/Configuration	4-16
Main Menu	4-19
Mass Storage Menu	4-20
Parameter Menu	4-21
Equipment Menu	4-23
HP-MSIB Map Screen Menu	4-26
Test Menu	4-26
Error Messages	4-29
Test Descriptions	4-31
Test List	4-31
1. Effective Number of Bits	4-31
2. Distortion	4-32
3. Gain Accuracy	4-33
4. Offset Accuracy	4-33
5. Frequency Response	4-34
6. Input Isolation	4-35
7. Reference Clock Accuracy	4-36
8. Random-Event Capture	4-37
9. External Trigger	4-37
10. High Sweep	4-38
11. Input Verification	4-39
12. Sync Out	4-40
Chapter 5. Troubleshooting	5-1
Troubleshooting Tools	5-2
Modular Measurement System Terms	5-2
Status Indicators	5-3
Error Message Reporting	5-4
HP 70700A Digitizer Self-Test	5-6

CONTENTS, Continued

Display Tests	5-8
Confidence Test Softkey	5-10
Performance Tests	5-11
HP-MSIB Troubleshooting Utility	5-11
Diagnostic Procedures	5-12
Categorizing Failures	5-12
Troubleshooting from the Front Panel	5-13
Troubleshooting over HP-IB	5-14
Troubleshooting Catastrophic Failures	5-14
Using the HP-MSIB Troubleshooting Utility	5-18
Error Codes	5-24
HP 70700A Digitizer Error Codes	5-24
Display Error Codes	5-32
Replaceable System Parts	5-36
Ordering Information	5-36
Direct Mail-Order System	5-37
Replaceable Parts Tables	5-37

LIST OF ILLUSTRATIONS

Figure Title	Page No.
1-1. HP 70700A Digitizer	1-4
1-2. Display Firmware Version	1-7
1-3. HP 70700A Digitizer Firmware Versions	1-8
1-4. Rear-Fan Filter	1-12
1-5. Line Voltage Selection	1-14
1-6. Line Fuse Removal and Replacement	1-15
1-7. Front Handle Removal and Rack Mounting	1-19
1-8. Interconnecting System II Cabinets	1-21
1-9. Packaging Materials for Mainframe	1-23
1-10. Packaging Materials for Modules	1-24
1-11. Static-Safe Workstation	1-25
2-1. Module Removal/Replacement	2-3
2-2. Mainframe-to-Mainframe	2-4
2-3. Mainframe-to-Mainframe-to-System Graphics Display	2-5
2-4. Single-Digitizer System	2-6
2-5. Multiple-Digitizer System	2-8
2-6. Digitizer Slave in a Spectrum Analyzer System	2-9
2-7. Digitizer Instrument with a Spectrum Analyzer System	2-10
2-8. Address Matrix	2-12
2-9. Master/Slave Addressing	2-15
2-10. Address Switches—HP 70700A	2-16
2-11. Address Switches—Display	2-17
3-1. Physical Dimensions (Characteristic Only)	3-7
4-1. 1 MHz Low-Pass Filter, Schematic with Parts Identification	4-4
4-2. 10 MHz Low-Pass Filter, Schematic with Parts Identification	4-5
4-3. Main Menu Softkeys	4-11
4-4. Configuration Menus Softkeys	4-12
4-5. Test Menu Softkeys	4-13

LIST OF ILLUSTRATIONS, Continued

4-6. Acceptable Measurement Range	4-14
4-7. Sync Output	4-41
5-1. HP 70700A Digitizer Error Reporting	5-4
5-2. Error Report Screen	5-5
5-3. <i>MORE ERRORS</i> Softkey	5-6
5-4. <i>utility</i> Softkey	5-7
5-5. <i>SELF TEST</i> Sofkey	5-7
5-6. <i>DISPLAY TESTS</i> Softkey	5-8
5-7. Display Tests Screen	5-8
5-8. Knob Test Display	5-9
5-9. Confidence Test Results	5-10
5-10. Knob Test Display	5-19
5-11. HP-MSIB Troubleshooting Utility	5-20
5-12. Alphabetical Softkeys	5-21
5-13. Completed HP-MSIB Communication	5-22

LIST OF TABLES

Table Title	Page No.
1-1. HP 70700A Digitizer Input Selection and Input Impedance	1-6
1-2. Power Cables	1-17
2-1. HP-MSIB Functions and Capabilities	2-14
2-2. Systems and Options	2-32
2-3. Replaceable Parts	2-34
4-1. Required Test Equipment and Accessories	4-2
4-2. Critical Specifications for Test Equipment	4-3
5-1. Decimal/Hexadecimal Conversion	5-21
5-2. Cabinet Interconnect and Rack-Mounting Kits	5-37
5-3. Firmware Upgrade Kits	5-38
5-4. Interconnection Cables and Accessories	5-38
5-5. Miscellaneous System-Level Parts	5-39
5-6. Service Accessories	5-39

HP 70000 MODULAR MEASUREMENT SYSTEM DOCUMENTATION OUTLINE

Instruments and modules of the HP 70000 Modular Measurement System are documented to varying levels of detail. Modules that serve as masters of an instrument require operation information in addition to installation and verification instructions. Modules that function as slaves in a system require only a subset of installation and verification information. Service documentation is available for every module of the HP 70000 Modular Measurement System family.

USER MANUALS, SUPPLIED WITH MODULE

Installation and Verification Manual

Topics covered by this manual include installation, specifications, verification of module operation, and some troubleshooting techniques. Manuals for modules that serve as instrument masters will supply information in all these areas; manuals for slave modules will contain only information needed for slave module installation and verification. Master module documentation may also include some system-level information.

Operation Manual

Information in this manual usually pertains to multiple- and single-module instrument systems. The Operation manual describes manual operation of the module, with explanations of softkeys and their use.

Programming Manual

Information in this manual usually pertains to multiple- and single-module instrument systems. The Programming Manual defines commands that enable remote operation of the module, and describes remote command syntax.

SERVICE MANUAL, AVAILABLE SEPARATELY

Technical Reference

This manual provides service information for a module, including performance verification, adjustments, troubleshooting, replaceable parts lists, replacement procedures, schematics, and component location diagrams. For ordering information, contact an HP Sales and Service Office.

SYSTEMS/COMPONENTS COVERED BY THIS MANUAL

This manual supplies installation and verification information for HP 70700A Digitizers used in single- and multiple-channel digitizer systems.

Also given, in Chapter 2, are examples of HP 70700A Digitizers used in spectrum analyzer systems. For more information about HP 70700A Digitizers used in systems, refer to the appropriate system's documentation. (For example, refer to the HP 70900A Local Oscillator Installation and Verification Manual for more information about installation and verification of an HP 70700A Digitizer in a spectrum analyzer system.)

CONTENTS

Chapter 1. General Information	1-1
Introduction	1-1
Safety	1-1
Printing Conventions	1-2
Software Media	1-2
Description of the HP 70700A Digitizer	1-3
Front Panel	1-3
Rear Panel	1-5
Software/Firmware Compatibility	1-7
HP 70700A Verification Software	1-7
Display Firmware	1-7
HP 70700A Digitizer Firmware	1-8
HP 70900A Local Oscillator Firmware	1-8
Options	1-10
W30 Service Option	1-10
Module/Instrument Options	1-10
Accessories	1-12
Rear Fan Filter	1-12
Display Screen Cleaner	1-12
Probes	1-12
Operating Requirements	1-14
Physical Requirements	1-14
Power Requirements	1-14
Initial Inspection and Setup	1-18
Inspection	1-18
Front Handle Removal and Replacement	1-18
Rack-Mounting	1-20
Rack-Mounting with Slides	1-20
Connecting Instrument Cabinets	1-20
Packaging	1-22
Electrostatic Discharge Information	1-25
Reducing Damage Caused by ESD	1-25
Static-Safe Accessories	1-26

Chapter 1

GENERAL INFORMATION

INTRODUCTION

This chapter contains the following information:

- Introduction
- Description of the HP 70700A Digitizer module
- HP 70700A Digitizer software/firmware compatibility
- Options and accessories
- Operating requirements
- Initial inspection and setup
- Packaging
- Electrostatic discharge (ESD)

SAFETY

Before operating this instrument, read the safety markings on the instrument and the safety instructions in the manuals.

The instrument is manufactured and tested to international safety standards. However, to prevent instrument damage and ensure your personal safety, all cautions and warnings must be heeded.

Refer to the summary of safety information in the front of the manual.

PRINTING CONVENTIONS

The conventions listed below are used throughout this manual.

"Hard" keys, keys physically on an instrument, are represented in the following way:

Key [KEY]

Softkeys, keys defined by software or firmware, are represented in the following way:

Softkey *softkey*

Text that appears on the CRT is represented in the following way:

Screen text *screen text*

SOFTWARE MEDIA

When software (e.g., HP 70700A Digitizer Performance Test Software) is shipped with an instrument, the standard media are 3-1/2" discs.

When Option 655 has been ordered, 5-1/4" discs are provided at instrument shipment.

DESCRIPTION OF THE HP 70700A DIGITIZER

The HP 70700A Digitizer is a 1/8 module, with a 20 MHz sampling rate, designed to work in an HP 70000 Series mainframe. It has both HP-IB (Hewlett-Packard Interface Bus) and HP-MSIB (Hewlett-Packard Modular System Interface Bus) communication capabilities. HP 70700A Digitizer configuration (addressing and cabling) varies depending on the application of the digitizer. The HP 70700A Digitizer can be used in the following applications:

- Single-channel digitizer system, with only one HP 70700A Digitizer
- Multiple-channel digitizer system, with one HP 70700A Digitizer functioning as a master to other HP 70700A Digitizers
- In an HP 70000 Series Modular Spectrum Analyzer system, configured as a slave to an HP 70900A Local Oscillator
- With an HP 70000 Series Modular Spectrum Analyzer system, configured as a separate digitizer instrument (In this application, the HP 70700A Digitizer is used to view the spectrum analyzer video output, and is not a slave of the spectrum analyzer.)

A digitizer system, with one or multiple HP 70700A Digitizers, provides waveform digitizing and analysis capabilities. Used in spectrum analyzer systems, the HP 70700A Digitizers provide enhanced zero-span video capture capabilities and faster swept sweep-times.

Below are short descriptions of the HP 70700A Digitizer front and rear panels (see Figure 1-1). The configuration in which the HP 70700A Digitizer is used determines its preset input selection and input impedance, and whether these settings can be changed using softkeys. Table 1-1 shows the preset inputs and input impedance, and softkey-selected alternatives, for different configurations.

Chapter 3 of this manual contains input and output specifications and characteristics. Chapter 2 contains addressing and system configuration information. Refer to the HP 70700A Digitizer Operation Manual for detailed descriptions of the front- and rear-panel features, the softkeys, and manual operation information. Refer to the Programming Manual for remote operation information.

FRONT PANEL

Front-Panel LEDs

The front-panel LEDs indicate the status of the HP 70700A Digitizer or its slave(s). The front-panel LEDs should turn on and off while the HP 70700A Digitizer is doing its self-test (e.g., at turn-on).

If the ERR (error) LEDs light at any time other than during self-test, there is a problem with the HP 70700A Digitizer, or with one of the other components in the system. (Refer to Chapter 5 for more information.)

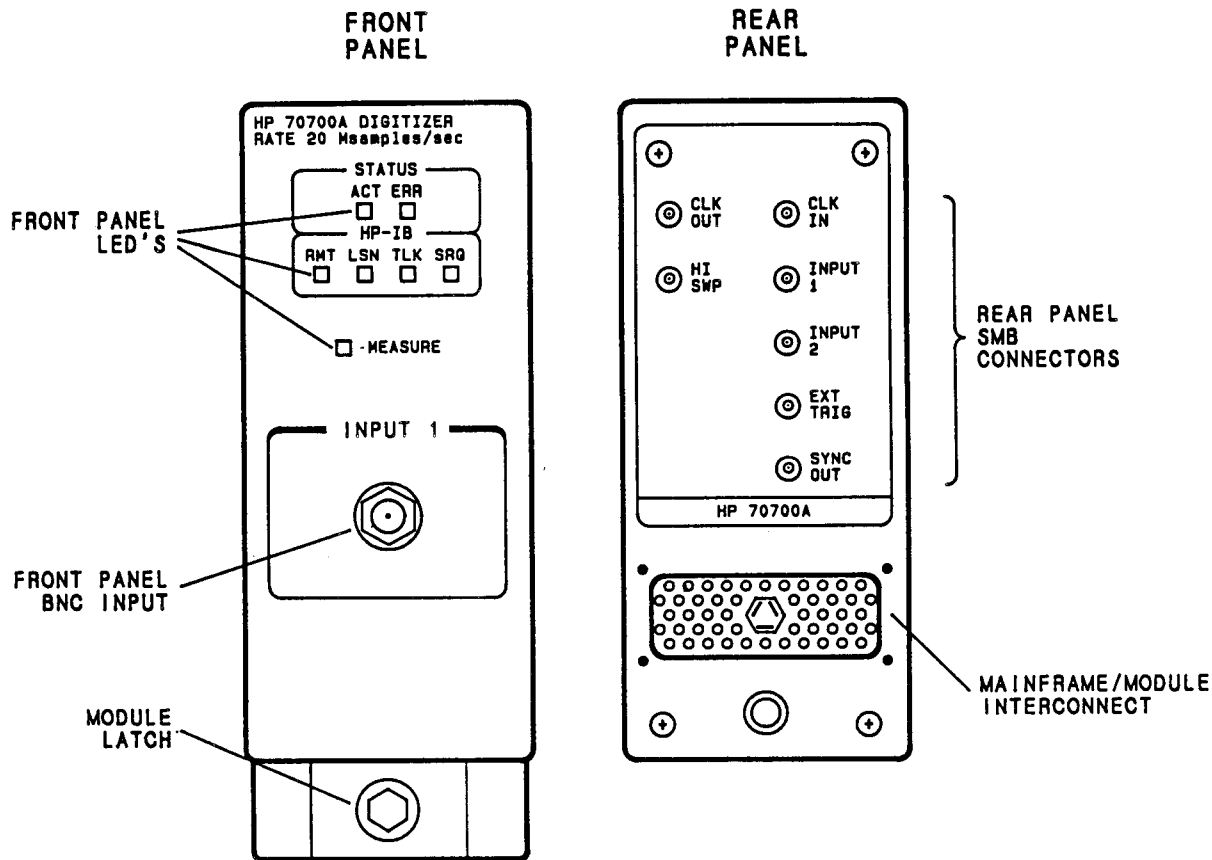

Figure 1-1. HP 70700A Digitizer

The SRQ (service request) LED can be set by the user to light when certain conditions occur (e.g., an error condition, or completion of an operation). Otherwise, it will only be lit during self-test, when it is turned on and off to test the LED.

The other LEDs, ACT (active), RMT (remote), LSN (listen), TLK (talk), and MEASURE, indicate types of activity that the HP 70700A Digitizer is engaged in, and do not indicate an error condition.

Front-Panel BNC Input

INPUT 1 can be utilized only when the HP 70700A Digitizer is used in a digitizer system, or as a separate digitizer instrument with a non-digitizer (e.g., spectrum analyzer) system. The front-panel INPUT 1 and the rear-panel INPUT 1 are connected together and are electrically the same. Refer to Table 1-1 for more information about input selection and input impedance for the different configurations.

Module Latch

An 8 mm hex-ball driver is used to turn the module hex-nut latch for installation of the module in a mainframe. Chapter 2 contains module installation and removal instructions.

REAR PANEL

Rear-Panel SMB Connectors

CLK OUT (clock out) provides a TTL-level 20 MHz clock. When one HP 70700A Digitizer is being used, CLK OUT is connected to the module's own CLK IN (clock in). In a digitizer system with multiple HP 70700A Digitizers, CLK OUT of the master HP 70700A Digitizer is connected both to its own CLK IN and to CLK IN of its slaves. (The cable lengths must be the same from CLK OUT to each of the CLK IN's.)

CLK IN (clock in) requires a 50% duty cycle, TTL-level clock input with a 10 MHz to 20 MHz frequency. (See CLK OUT above.)

HI SWP (High Sweep) is both an input and an output. When an HP 70700A Digitizer is used as a slave to the HP 70900A Local Oscillator in a spectrum analyzer system, the HP 70700A Digitizer HI SWP is connected to the HP 70900A Local Oscillator's H SWP (High Sweep input/output) to synchronize the HP 70700A Digitizer and the HP 70900A Local Oscillator.

INPUT 1 can be utilized only when the HP 70700A Digitizer is used in a digitizer system, or as a separate digitizer instrument with a non-digitizer (e.g., spectrum analyzer) system. The front-panel INPUT 1 and the rear-panel INPUT 1 are connected together and are electrically the same. Refer to Table 1-1 for more information about input selection and input impedance for the different configurations.

INPUT 2 can be utilized when the HP 70700A Digitizer is used in any type of configuration. INPUT 2 is the preset input when the HP 70700A Digitizer is used as a slave to a non-digitizer master (e.g., an HP 70900A Local Oscillator). When the HP 70700A Digitizer is used in a digitizer system, or as a digitizer instrument with a non-digitizer system, INPUT 2 is preset open (i.e., no connection). Refer to Table 1-1 for more information about input selection and input impedance.

EXT TRIG (external trigger input) allows an external input signal to be used to trigger the module externally. The input signal must be TTL with a pulse width of at least one clock period, typically 50 ns. (See SYNC OUT below.) When an HP 70700A Digitizer is used with a spectrum analyzer system, either as a slave or as a digitizer instrument, the H SWP of the HP 70900A Local Oscillator is connected to the HP 70700A Digitizer EXT TRIG input.

SYNC OUT provides a TTL-level signal used to synchronize other HP 70700A Digitizers. In a digitizer system with multiple HP 70700A Digitizers, the SYNC OUT of the master HP 70700A Digitizer is connected to the EXT TRIG of its slave HP 70700A Digitizers. (The cable lengths from SYNC OUT to each of the slave EXT TRIG's must be the same.)

Mainframe/Module Interconnect

The mainframe provides the power supply, HP-MSIB connections, and HP-IB connections for the module through this mainframe/module interconnect.

NOTE

Only elements that have been designed with HP-IB capability, and are addressed at row 0, are able to communicate over HP-IB. (Refer to Chapter 2 for more addressing information.)

Table 1-1. HP 70700A Digitizer Input Selection and Input Impedance

HP 70700A Digitizer used in a digitizer system, or as a digitizer instrument in a non-digitizer system:	
Preset Input	INPUT 1
Softkey-Selected Input	INPUT 2
Preset Input Impedance	DC Coupled 1 M Ω
Softkey-Selected Input Impedance	AC Coupled 1 Ω , or DC Coupled 50 Ω
HP 70700A Digitizer used as a slave to a non-digitizer master:	
Preset Input	INPUT 2
Softkey-Selected Input	none
Preset Input Impedance	DC Coupled 1 M Ω
Softkey-Selected Input Impedance	none

SOFTWARE/FIRMWARE COMPATIBILITY

HP 70700A VERIFICATION SOFTWARE

All versions of HP 70700A Digitizer firmware are compatible with all versions of HP 70700A Digitizer verification software.

DISPLAY FIRMWARE

For full utilization of the HP 70700A Digitizer, both in digitizer and spectrum analyzer systems, the display (e.g., HP 70205A) must have a dot generator release version of 3.2 or later.

The display ID screen, which shows the display firmware (ROM) version, display address, and dot generator release version, flashes on the screen at instrument turn-on. (See Figure 1-2.) The display ID screen can also be accessed using the following steps:

1. Press the [DISPLAY] key on the display.
2. When the Display screen appears, press DISPLAY TESTS.
3. When the Display Test screen appears, press DISPLAY ID.

NOTE

If the display ID screen stays on the CRT at instrument turn-on, the display window may need to be assigned. Assign the display window to the master with the lowest column address by pressing [DISPLAY], then SELECT INSTR. To assign the display window to the master with the next-highest address, press [↑].

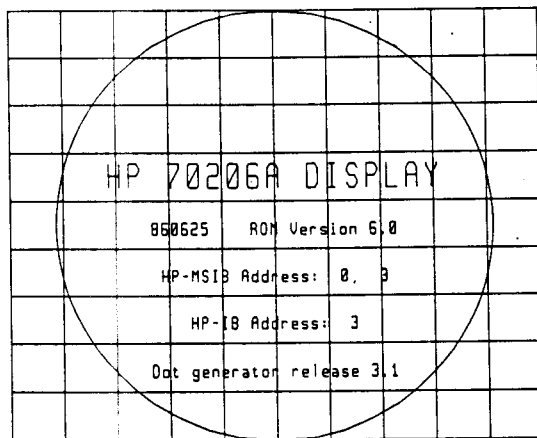

Figure 1-2. Display Firmware Versions

HP 70700A DIGITIZER FIRMWARE

The HP 70700A Digitizer has both ROM (read-only memory) and RAM (random-access memory). All versions of HP 70700A Digitizer ROM and RAM are compatible with each other.

Both types of memory have data loaded into them when the digitizer is produced. The RAM may have its data erased under some conditions (e.g., the battery on the A5 Processor board's failing or being shorted).

A service accessory is available to allow reloading of the data in the RAM using HP Series 200 or Series 300 Computers. Refer to Chapter 5 for the part number of the service accessory.

The HP 70700A Digitizer firmware (ROM and RAM) versions appear on the screen at instrument turn-on and remain on the screen until a key is pressed. This information can be obtained over HP-IB using the remote command *IDN. It can also be obtained by using the following procedure from the front panel:

1. Press the [MENU] key on the display.
2. When the menu screen appears, press *utility*.
3. When the next menu screen appears, press *ROM VERSION*. The ROM and RAM versions will appear on the screen as shown in Figure 1-3.

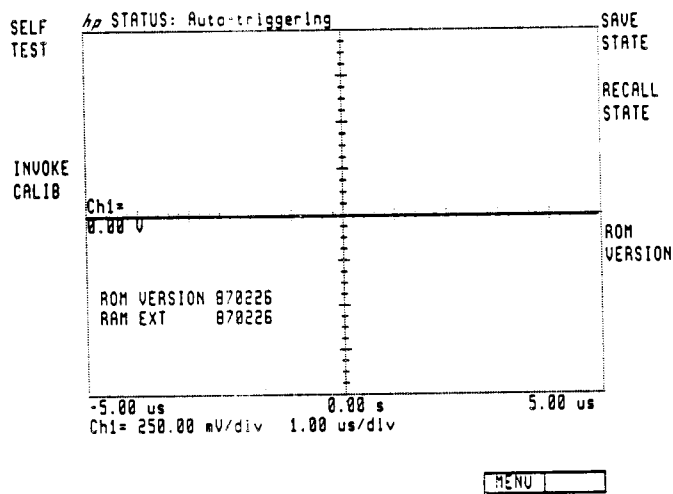

Figure 1-3. HP 70700A Digitizer Firmware Versions

HP 70900A LOCAL OSCILLATOR FIRMWARE

For an HP 70700A Digitizer to function as a slave to an LO (HP 70900A Local Oscillator), the LO must have a firmware version of 870501 or later.

The firmware (ROM) version of the local oscillator can be ascertained as follows:

1. Press the [MENU] key on the display.

2. When the menu screen appears, press CONFIG.
3. When the next menu screen appears, press ROM VERSION. The ROM version will be shown in a box in the upper right-hand corner of the screen.

OPTIONS

W30 SERVICE OPTION

Option W30 (where available) supplies an additional two years of Return-to-HP service. All products have a one year warranty. Option W30 coverage is for years two and three after the product's one year of warranty.

This option is ordered by the customer when the product is ordered. Call your nearest Hewlett-Packard office for Option W30 price information.

MODULE/INSTRUMENT OPTIONS

HP 70001A Mainframe Options

Option 010 is a rack-mount slide kit for mounting a mainframe in an HP rack.

Option 400 provides an in-line isolation transformer for use with the mainframe during 400 Hz operation.

Option 908 is a rack-mount flange kit for a mainframe without handles.

Option 913 is a rack-mount flange kit for a mainframe with handles.

HP 70206A System Graphics Display Options

Option 011 is a rack-mount slide kit for mounting a stand-alone display in an HP rack.

Option 400 provides an in-line isolation transformer for use with the stand-alone display during 400 Hz operation.

Option 908 is a rack-mount flange kit for a stand-alone display without handles.

Option 913 is a rack-mount flange kit for a stand-alone display with handles.

HP 70700A Digitizer Options

Option 098 adds a retrofit kit containing updated firmware for an HP 70900A Local Oscillator with a firmware date of 860203 or earlier. Adding this firmware to the HP 70900A Local Oscillator allows the HP 70700A Digitizer to work as a slave to the HP 70900A Local Oscillator.

Option 099 adds a retrofit kit containing updated firmware for an HP 70900A Local Oscillator with a firmware date of 861015. Adding this firmware to the HP 70900A Local Oscillator allows the HP 70700A Digitizer to work as a slave to the HP 70900A Local Oscillator.

Option 655 changes the media of the software shipped with the instrument from the standard 3-1/2" discs to 5-1/4" discs.

Option 910 provides the following extra manual set:

- HP 70700A Digitizer Operation Manual
- HP 70700A Digitizer Programming Manual
- HP 70700A Digitizer Installation and Verification Manual

Option 915 provides the following service documentation:

- HP 70700A Digitizer Technical Reference
(including Module Verification software)

ACCESSORIES

REAR FAN FILTER

An optional Rear Fan Filter is available for the mainframe to reduce the amount of dust that enters the instrument. Figure 1-4 illustrates filter installation.

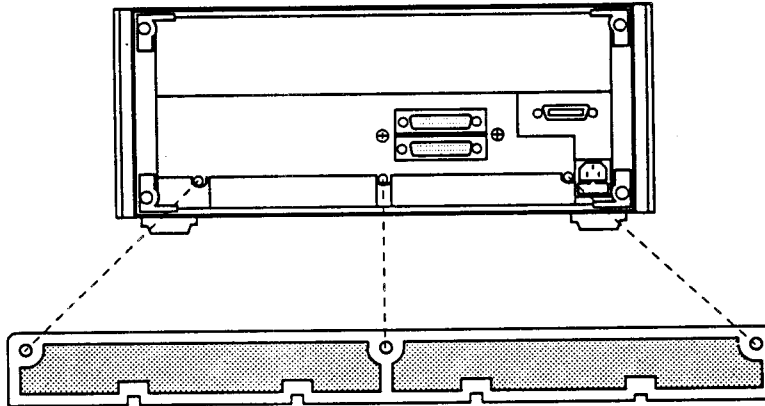

HP 70001-40017

Figure 1-4. Rear Fan Filter

DISPLAY SCREEN CLEANER

To avoid damaging the coating on the display CRT, use a thin film cleaner such as Hewlett-Packard Display Cleaner (HP Part Number 8500-2163). This should be used with an abrasion-free cleaning tissue or soft cloth.

CAUTION

Paper towels, both hand and laboratory, should not be used to clean the screen, because they may scratch the coating.

PROBES

The following probes are recommended for use with the HP 70700A Digitizer. For more information about them, or other accessories that may be used with the HP 70700A Digitizer, call your nearest Hewlett-Packard sales office.

HP 10001A has a division ratio of 10:1, input resistance of 10 M Ω , and a length of 1.5 metres (5 feet).

HP 10002A has a division ratio of 50:1, input resistance of 9 M Ω , and a length of 1.5 metres (5 feet).

HP 10003A has a division ratio of 10:1, input resistance of 10 M Ω , and a length of 1.3 metres (4 feet).

HP 10007B has a division ratio of 1:1, and a length of 1.1 metres (3.5 feet).

HP 10008A has a division ratio of 1:1, and a length of 1.8 metres (6 feet).

HP 10026A has a division ratio of 1:1, input resistance of 50 Ω , and a length of 1 metre (3.3 feet).

OPERATING REQUIREMENTS

PHYSICAL REQUIREMENTS

See Chapter 3 for instrument weights and dimensions, along with temperature and humidity requirements.

POWER REQUIREMENTS

For line-voltage power requirements, see Chapter 3.

WARNING

BEFORE TURNING THIS INSTRUMENT ON, make sure it is grounded through the protective conductor of the power cable to a socket outlet provided with protective earth contact. Any interruption of the protective (grounding) conductor inside or outside the instrument, or disconnection of the protective earth terminal, can result in personal injury.

Line Voltage Selection

CAUTION

BEFORE TURNING THIS INSTRUMENT ON, set the **LINE VOLTAGE SELECTOR** to the voltage of the power source. Failure to do this could cause instrument damage when the power cable is plugged in.

Use the **LINE VOLTAGE SELECTOR** (see Figure 1-5) to select a line voltage. The mainframe **LINE VOLTAGE SELECTOR** switch is located on the mainframe bottom. The **LINE VOLTAGE SELECTOR** switch for the stand-alone display is located on its rear panel.

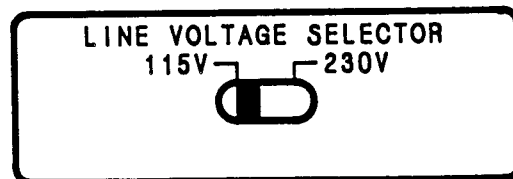

Figure 1-5. Line Voltage Selection

Fuse Replacement

The line module housing at the rear of the instrument contains both the instrument line fuse and a spare fuse. These metric 6.3A fuses (HP Part Number 2110-0703) are used in both 120V and 230V applications. Figure 1-6 illustrates fuse removal and replacement.

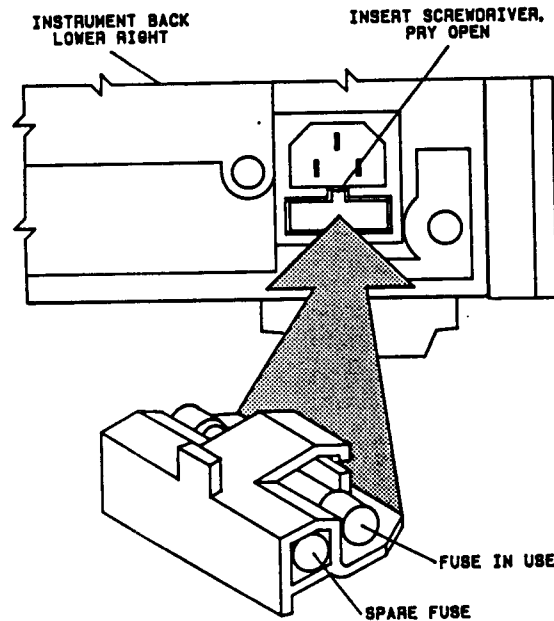

Figure 1-6. Line Fuse Removal and Replacement

400 Hz Option

Both the mainframe and stand-alone display are available with an option that allows them to run on a power-line frequency of 400 Hz. These 400 Hz options come with an external in-line isolation transformer that must be used when the instrument uses a 400 Hz power source. (Refer to Chapter 5 for replaceable parts information.)

WARNING

Never operate a 400 Hz option instrument on a 400 Hz power line without the included in-line isolation transformer. Failure to follow this precaution can result in personal injury.

The 400 Hz option can be operated on a 60 Hz power line if the in-line isolation transformer is detached from the instrument and a standard power cord is used. The in-line isolation transformer must be reattached before the instrument is plugged into a 400 Hz power line source. The in-line isolation transformer protects the user from shock hazard in the event the power-line source is incorrectly grounded.

For 400 Hz option specifications, see Chapter 3.



GENERAL INFORMATION

Power Cables

In accordance with international safety standards, this instrument is supplied with a three-wire power cable. When connected to an appropriate and properly grounded power receptacle, this cable grounds the instrument cabinet.

The type of power cable shipped with the instrument depends on the country of destination. If additional or different cables are needed, refer to Table 1-2 for power cable descriptions and HP part numbers.

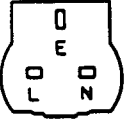
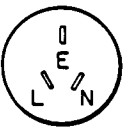
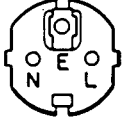
Table 1-2. Power Cables

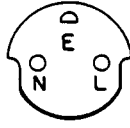
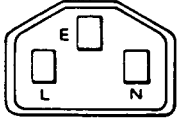
Plug Type**	Cable HP Part Number	Plug Description	Cable Length cm (inches)	Cable Color	For Use In Country
250V 	8120-1351 8120-1703	Straight*BS1363A 90°	229 (90) 229 (90)	Mint Gray Mint Gray	Great Britain, Cyprus, Nigeria, Rhodesia, Singapore, So. Africa, India
250V 	8120-1369 8120-0696	Straight*NZSS198/ASC112 90°	201 (79) 221 (87)	Gray Gray	Australia, New Zealand
250V 	8120-1689 8120-1692	Straight*CEE7-Y11 90°	201 (79) 201 (79)	Mint Gray Mint Gray	East and West Europe, Saudi Arabia, United Arab Republic (unpolarized in many nations)
125V 	8120-1348 8120-1398 8120-1754	Straight*NEMA5-15P 90° Straight*NEMA5-15P	203 (80) 203 (80) 91 (36)	Black Black Black	United States Canada, Japan (100 or 200V), Mexico, Phillipines, Taiwan
	8120-1378 8120-1521 8120-1676	Straight*NEMA5-15P 90° Straight*NEMA5-15P	203 (80) 203 (80) 91 (36)	Jade Gray Jade Gray Jade Gray	
250V 	8120-2104	Straight*SEV1011 1959-24507 Type 12	201 (79)	Gray	Switzerland
220V 	8120-0698	Straight*NEMA6-15P			
250V 	8120-1860	Straight*CEEE22-VI			
<p>* Part number shown for plug is industry identifier for plug only. Number shown for cable is HP Part Number for complete cable, including plug.</p> <p>** E = Earth Ground; L = Line; N = Neutral.</p>					

INITIAL INSPECTION AND SETUP

The information given below covers initial inspection of the instrument after its arrival, removing and replacing the instrument's front handles, rack-mounting and connecting instrument cabinets.

Refer to Chapter 2 for information about module installation and removal, cable connections, and addressing.

INSPECTION

Inspect the shipping container for damage. If the container or cushioning material is damaged, check the contents of the shipment both mechanically and electrically. To check electrical performance, run the performance tests. (Refer to Chapter 4.)

If the instrument is damaged or defective, contact the nearest Hewlett-Packard office. Hewlett-Packard will arrange for repair or replacement of the damaged or defective equipment without waiting for a claim settlement. Keep the shipping materials for the carrier's inspection.

For convenience in bench operation, the stand-alone displays have fold-away tilt stands. Both the stand-alone displays and mainframes have plastic feet that are shaped to make full-width cabinets self-aligning when stacked. The stand-alone displays (e.g., HP 70206A System Graphics Display) and mainframes are shipped with front handles attached for ease of moving. The stand-alone displays and most mainframes also have side strap handles.

WARNING

Do not install side strap handles on HP 70001A Mainframes with a serial prefix of 2504A or below without first installing a new rear frame. In a mainframe with an old rear frame, the weight of the mainframe and modules can loosen the handle, allowing the instrument to drop. This could cause personal injury. Consult with your nearest HP service office for more information.

Keep undamaged shipping materials for future shipment or storage of the instrument. The original HP shipping materials, or the equivalent, are required for reshipment of instruments. Using substandard packaging can result in instrument damage. Read Packaging in this chapter for packaging information and requirements.

FRONT HANDLE REMOVAL AND REPLACEMENT

NOTE

When replacing parts in this instrument, be sure to use identical hardware. This instrument contains both metric and English hardware.

To install rack-mounting options, the front handles need to be removed. See Figure 1-7 for instructions.

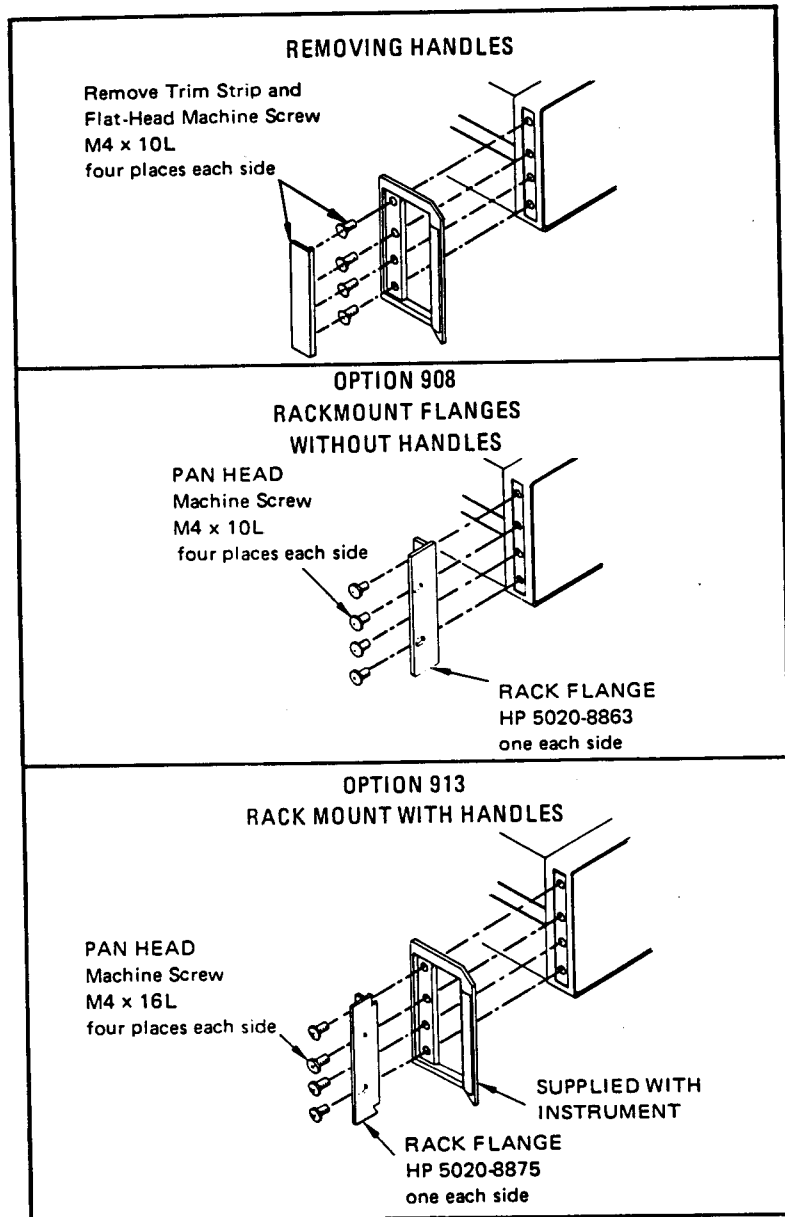

NOTE: LEFT FRONT IS SHOWN IN EACH EXAMPLE.

Figure 1-7. Front Handle Removal and Rack Mounting

CAUTION

Do not rack-mount combined instrument cabinets; use separate rack-mounting kits for each cabinet.

RACK-MOUNTING

Options 908 and 913 for the mainframe and stand-alone display contain the necessary hardware to mount the instrument in a rack with 482.6 mm (19 inches) spacing. Rack-mounting without handles requires Option 908; rack-mounting with handles requires Option 913.

See Figure 1-7 for correct screw size and positioning of handles or brackets when installing rack-mount options. An angle bracket (HP Part Number 12679C) can be ordered to provide the additional support that is required at the rear or sides of the instrument.

RACK-MOUNTING WITH SLIDES

Option 010 contains the necessary hardware to attach slides to a mainframe and mount it in an HP rack with 482.6 mm (19 inch) spacing. Adapter kits are available to allow slide rack-mounting in non-HP racks.

Option 011 contains the necessary hardware to attach slides to a stand-alone display (e.g., HP 70206A) and mount it in an HP rack with 482.6 mm (19 inch) spacing. Adapter kits are available to allow slide rack-mounting in non-HP racks.

Refer to Chapter 5 for the part numbers of the slide rack-mount kits and their adapter kits. Instructions are included with each kit.

CONNECTING INSTRUMENT CABINETS

Connect instrument cabinets using the mainframe-to-mainframe or mainframe-to-System II Interconnect Kit. Refer to Chapter 5 for the part numbers of the interconnect kits.

Figure 1-8 illustrates the kit hardware used for vertically interconnecting the mainframe and various System II cabinets. The kit, which contains metric 4.0, 3.5, and English 6-32 screws, covers all mainframe and System II cabinet combinations.

CAUTION

The HP 70001A Mainframe and HP 70206A System Graphics Display contain metric 4.0 screws. Other System II cabinets contain metric 3.5 or English 6-32 screws. You will damage the cabinets, unless you use screws of the correct size, length, and thread type when connecting instrument cabinets.

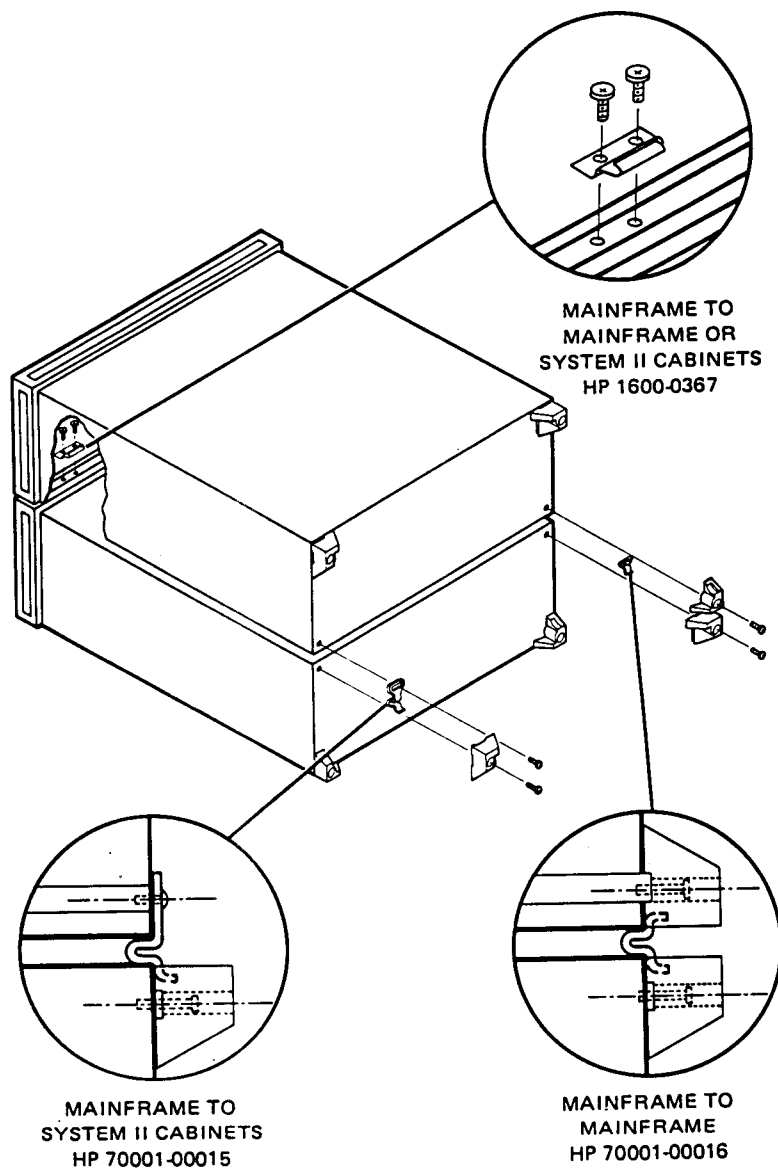

Figure 1-8. Interconnecting System II Cabinets

PACKAGING

The original shipping containers and materials, or the equivalent, must be used when repackaging the mainframe with modules or modules alone. Packaging materials identical to the original factory packaging can be purchased through any Hewlett-Packard office, including those listed at the rear of this book.

Figures 1-9 and 1-10 show the packaging materials. When ordering packaging materials to ship modules, it is necessary to order the proper number of foam inserts. A 3/8 module (e.g. HP 70205A Graphics Display) requires no foam inserts, a 2/8 module (e.g. HP 70900A Local Oscillator) requires one, and a 1/8 module (e.g. HP 70902A IF Section) requires two.

CAUTION

Instrument damage can result from using packaging materials other than those specified. Never use styrene pellets in any shape as packaging materials. They do not adequately cushion the instrument or prevent it from shifting in the carton. They cause instrument damage by generating static electricity and by lodging in the instrument fan.

If the original packaging materials are not available, and you do not wish to order new packaging materials, instruments can be repackaged for shipment using the following instructions.

1. Wrap the instrument in anti-static plastic to reduce the possibility of damage caused by electrostatic discharge.
2. For instruments that weigh less than 120 lbs, use a double-walled, corrugated cardboard carton of 350-lb test strength. The carton must be both large enough and strong enough to accommodate the instrument. Allow at least three to four inches on all sides of the instrument for packing material.
3. Surround the equipment with three to four inches of packing material, and prevent the instrument from moving in the carton. If packing foam is not available, the best alternative is S.D.-240 Air Cap from Sealed Air Corporation (Commerce, California, 90001). Air Cap looks like a plastic sheet filled with 1-1/4 inch air bubbles. Use the pink-colored Air Cap to reduce static electricity. Wrapping the instrument several times in this material should both protect the instrument and prevent it from moving in the carton.
4. If you are returning an instrument to Hewlett-Packard, fill out one of the blue repair cards (located at the rear of this manual) and include it in the package. If a tag is not available, make sure the following information is sent with the returned instrument:
 - a. Type of service required
 - b. Description of the problem; state if the problem is constant or intermittent
 - c. Name of technical contact person (please include phone number)
 - d. Return address

- e. Model number of returned instrument
 - f. Full serial number of returned instrument
 - g. List of any accessories returned with instrument
5. Seal the carton with strong nylon adhesive tape.
 6. Mark the carton "FRAGILE, HANDLE WITH CARE".

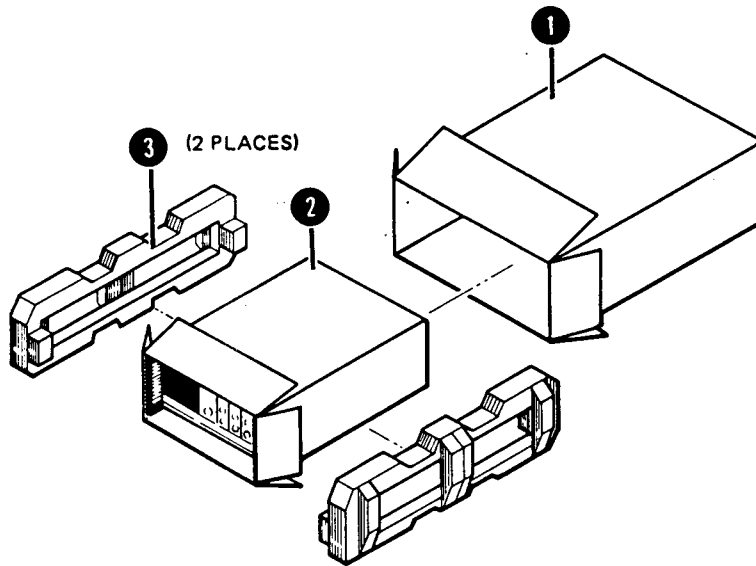

ITEM	QTY	HP PART NO.	DESCRIPTION
1	1	9211-4487	CARTON—OUTER
2	1	5180-2321	CARTON—INNER
3	2	5180-2319 OR 5180-7829	FOAM PADS (HP 70001A) FOAM PADS (HP 70206A)

Figure 1-9. Packaging Materials for Mainframe

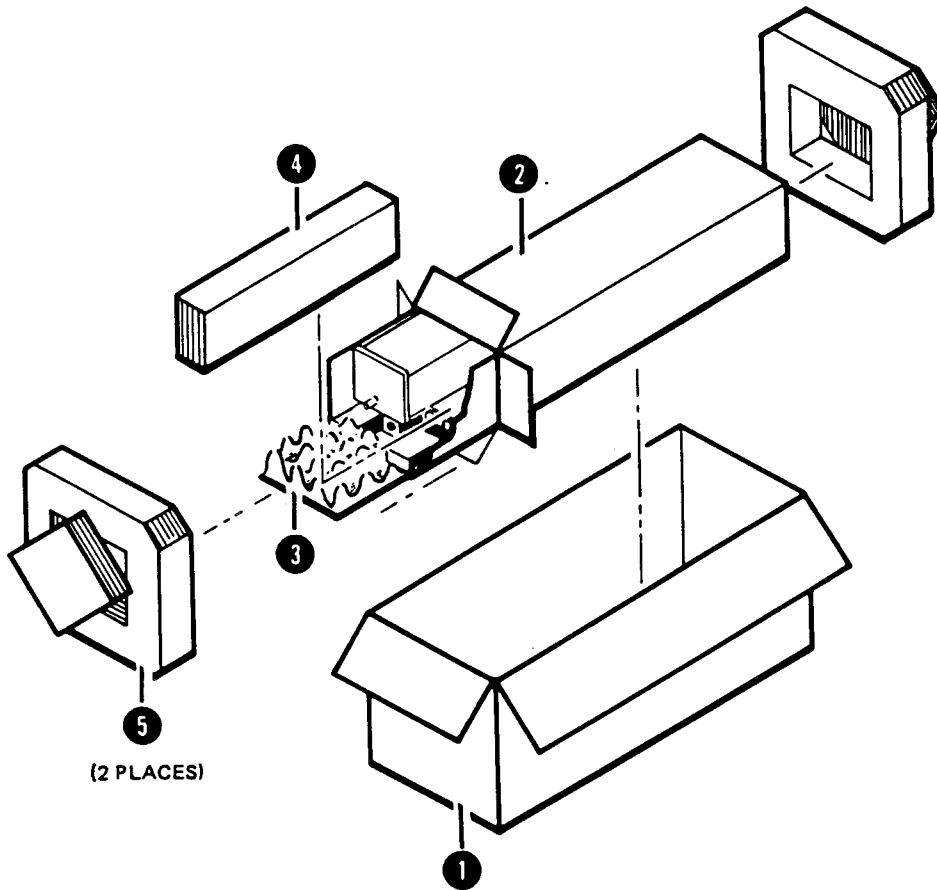

ITEM	QTY	HP PART NO.	DESCRIPTION
1	1	9211-5118	CARTON-OUTER
2	1	9211-5119	CARTON-INNER
3	1	5180-2369	CARTON-SLIDER
4		4280-0493	FOAM INSERT (FOR QUANTITY SEE TEXT)
5	2	5180-2370	FOAM PADS

Figure 1-10. Packaging Materials for Modules

ELECTROSTATIC DISCHARGE INFORMATION

Electrostatic discharge (ESD) can damage or destroy electronic components. Therefore, all work performed on assemblies consisting of electronic components should be done at a static-safe workstation.

Figure 1-11 shows an example of a static-safe workstation using two types of ESD protection: 1) conductive table mat and wrist strap combination, and 2) conductive floor mat and heel strap combination. These methods may be used together or separately. (A list of static-safe accessories and their part numbers is given on the following pages.)

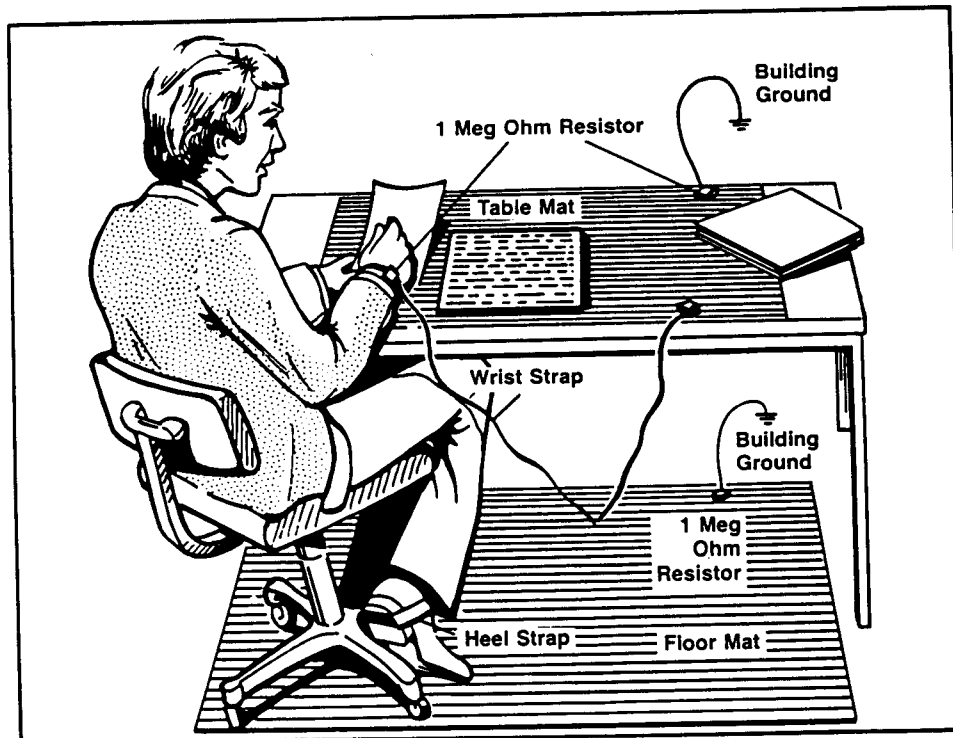

Figure 1-11. Static-Safe Workstation

REDUCING DAMAGE CAUSED BY ESD

Below are suggestions that may help reduce ESD damage that occurs during testing and servicing instruments.

PC Board Assemblies and Electronic Components

- Handle these items at a static-safe workstation.
- Store or transport these items in static-shielding containers.

CAUTION

Do not use erasers to clean the edge connector contacts. Erasers generate static electricity and remove the thin gold plating, which degrades the electrical quality of the contacts.

Do not use paper of any kind to clean the edge connector contacts. Paper or lint particles left on the contact surface can cause intermittent electrical connections.

Do not touch the edge connector contacts or trace surfaces with bare hands. Always handle board assemblies by the edges.

PC board assembly edge connector contacts may be cleaned by using a lint-free cloth with a solution of 80% electronics-grade isopropyl alcohol and 20% deionized water. This procedure should be performed at a static-safe workstation.

Test Equipment

- Before connecting any coaxial cable to an instrument connector for the first time each day, momentarily ground the center and outer conductors of the cable.
- Personnel should be grounded with a resistor-isolated wrist strap before touching the center pin of any connector and before removing any assembly from the instrument.
- Be sure that all instruments are properly earth-grounded to prevent buildup of static charge.

STATIC-SAFE ACCESSORIES

The following is a list of static-safe accessories that may be obtained from any Hewlett-Packard office by using the HP part numbers listed.

HP Part Number 9300-0797

Includes:

3M static control mat .6m × 1.2m
(2 ft. × 4 ft.)
4.6m (15 ft.) ground wire
wrist strap and attachment cord

HP Part Number 9300-0980

Wrist strap cord 1.5m (5 ft.)

HP Part Number 9300-0985

Wrist strap (large)

HP Part Number 9300-0986

Wrist strap (small)

HP Part Number 9300-1169

ESD heel strap (reusable 6 to 12 months)

HP Part Number 9300-0793

Shoe ground strap (one-time use only)

The following ESD accessories can be ordered from:

Hewlett-Packard Company
Computer Supplies Operations
1320 Kifer Road
Sunnyvale, California 94086
Phone: (408) 738-8858

HP Part Number 92175A
Black, hard-surface, static control mat
1.2m × 1.5m (4 ft. × 5 ft.)

HP Part Number 92175B
Brown, soft-surface, static control mat
2.4m × 1.2m (8 ft. × 4 ft.)

HP Part Number 92175C
Small, black, hard-surface, static control mat
1.2m × 0.9m (4 ft. × 3 ft.)

HP Part Number 92175T
Tabletop static control mat
58 cm × 76 cm (23 in. × 30 in.)

HP Part Number 92176A (natural color)
HP Part Number 92176C (russet color)
Anti-static carpet, 1.8m × 1.2m (6 ft. × 4 ft.)

HP Part Number 92176B (natural color)
HP Part Number 92176D (russet color)
Anti-static carpet, 2.4m × 1.2m (8 ft. × 4 ft.)

CONTENTS

Chapter 2. Installation 2-1
 Initial Power-On 2-2
 Module Installation and Removal 2-3
 Cable Connections and Addressing Examples 2-4
 HP-MSIB/HP-IB Addressing 2-11
 Modular Measurement System Terms 2-11
 Address Matrix 2-12
 Address Protocol 2-14
 Address Switches 2-15

Chapter 2

INSTALLATION

This chapter contains the following information:

- Initial power-on
- Module installation and removal
- Cable connection and addressing examples
- HP-MSIB/HP-IB addressing

Most HP 70000 Modular Measurement Series Systems are shipped in a preconfigured system model (e.g., HP 71100A). These preconfigured systems have already been addressed and have had their rear-panel inter-module cables connected.

If you do not have a preconfigured system, or if you want to check the system addressing and cable connections, refer to the following pages for more information. For information about rack-mounting, and connecting instrument cabinets, refer to Chapter 1.

NOTE

The address switches on the back of the HP 70206A System Graphics display are for the display instrument only. They do NOT set the address of the system. The system address can be set using the addressing rules explained in the HP-MSIB/HP-IB Addressing section.

NOTE

When the system is first turned on, the User screen softkeys may not be visible on the CRT. This is usually caused by the display window's not being assigned. Assign the display window to a master, with a row address of 0, by pressing [DISPLAY], then *SELECT INSTR.* This assigns the display to the master with the lowest column address. Press the [↑] key to assign the display to the master with the next-highest column address.

INITIAL POWER-ON

The following procedure may be used for the initial power-on:

1. Check the power cable (shipped with the system) for damage to the socket ends or cable cord.
2. If the cable is not damaged, set the mainframe and/or stand-alone display LINE switch to OFF, connect the power cable(s) to the system and then to the power source.
3. Set the mainframe and/or stand-alone display LINE switch to ON. The power light should come on, and the ventilation fan(s) should start.

NOTE

If the mainframe power light is on, but the ventilation fan does not start, set the mainframe LINE switch to OFF. Visually check for blockage of the fan intakes at the bottom rear of the mainframe. If the fan intakes appear clear and there are no other obvious causes for failure, contact a Hewlett-Packard office for instructions. If the power light on the mainframe or stand-alone display is not on, check the instrument fuse.

4. When the system is started, the indicator lights on the front panel of each module will turn on and off as the modules go through their self-test routine. If there is evidence of a problem after the self-test (e.g., an ERR light's remaining lit), refer to Chapter 5 for more information.

MODULE INSTALLATION AND REMOVAL

To install a module into the mainframe, follow these steps (see Figure 2-1):

1. Set the instrument LINE switch to OFF.
2. Swing the mainframe front door down. Note that the door will not open unless the LINE switch is OFF.
3. Check the module HP-MSIB address switches for correct addressing. (Refer to the addressing information in the following pages.)
4. Slide the module into the mainframe.
5. Tighten the module latch using an 8 mm hex-ball driver.
6. Connect the rear-panel inter-module cables (see the cable connection information on the following pages).

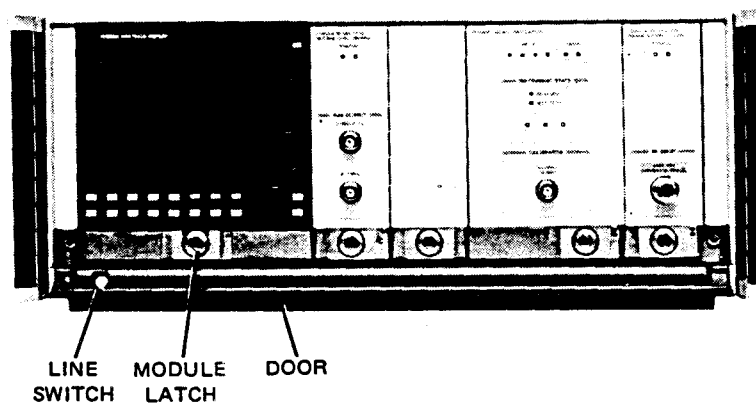

Figure 2-1. Module Removal/Replacement

To remove a module from the mainframe, follow these steps (see Figure 2-1):

1. Set the instrument LINE switch to OFF.
2. Remove the rear-panel inter-module cables.
3. Swing the mainframe front door down. Note that the door will not open unless the LINE switch is OFF.
4. Loosen the module latch using an 8 mm hex-ball driver.
5. Slide the module forward, out of the instrument.

CABLE CONNECTIONS AND ADDRESSING EXAMPLES

The following figures show the addressing order and cable hook-ups for some common system configurations. Each figure contains a sample Address Map (Display screen) illustrating the addressing order, and a partial view of the system rear-panel illustrating the cable hook-ups.

These figures are examples. To address a system differently than shown, see HP-MSIB/HP-IB Addressing.

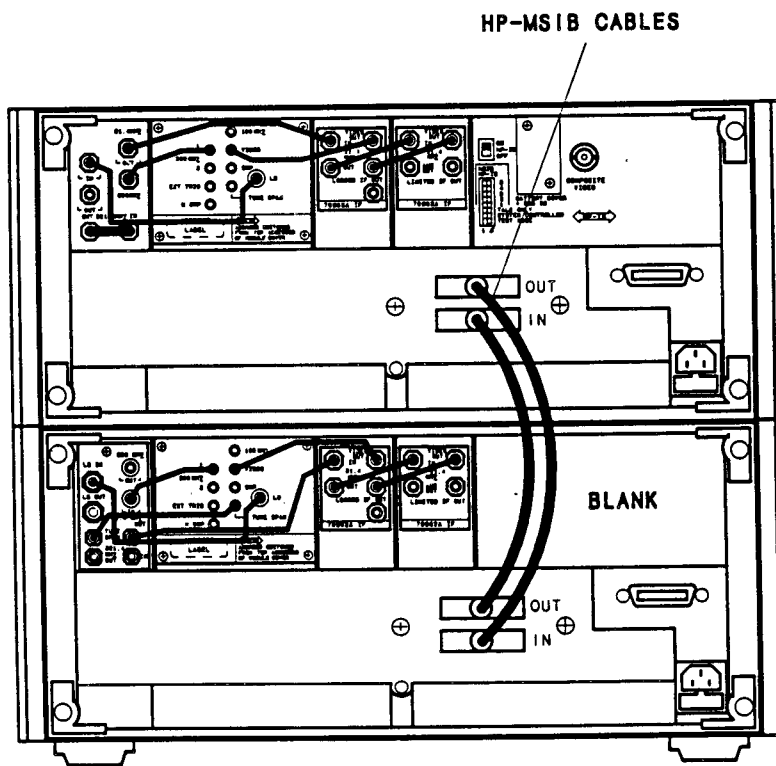

NOTE: ALWAYS CONNECT AN OUTPUT TO AN INPUT.

Figure 2-2. Mainframe-to-Mainframe

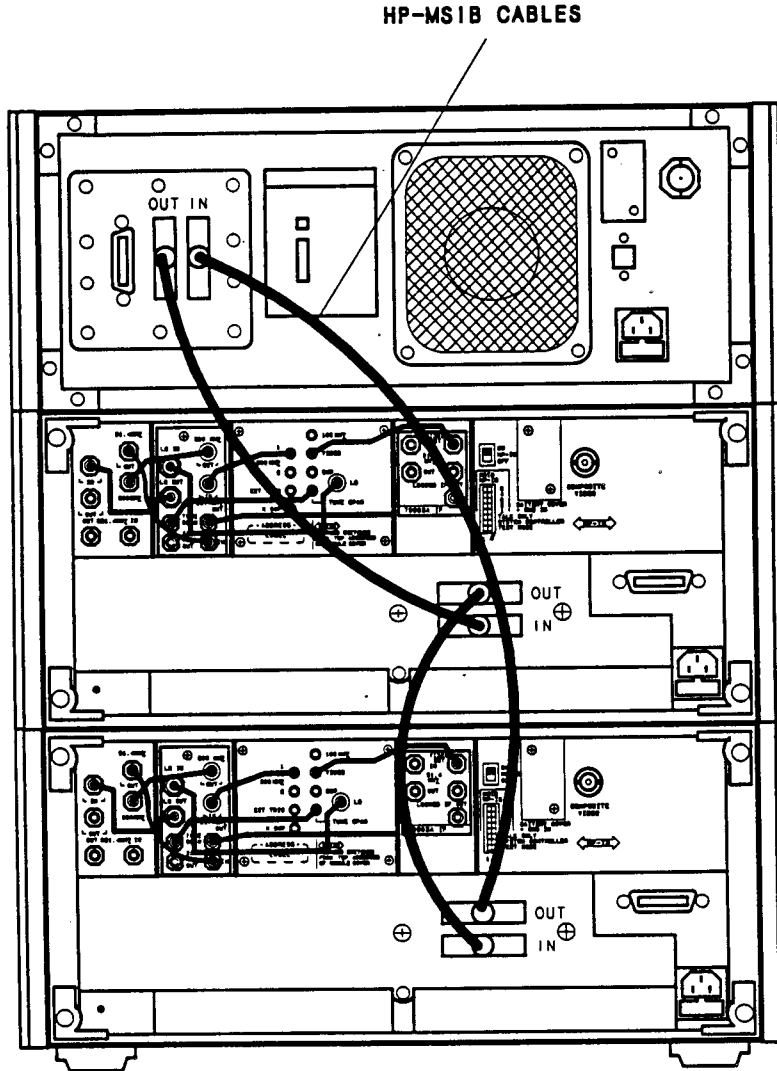

NOTE

ALWAYS CONNECT AN OUTPUT TO AN INPUT

Figure 2-3. Mainframe-to-Mainframe-to-System Graphics Display

SYSTEM COMPONENTS:

- HP 70001A MAINFRAME
- HP 70205A GRAPHICS DISPLAY
- HP 70700A DIGITIZER

NOTES:

1. THE CHANNEL ASSIGNED TO EACH HP 70700A DIGITIZER DEPENDS UPON ITS ADDRESS. REFER TO THE HP-MSIB/HP-IB ADDRESSING CHAPTER FOR MORE INFORMATION.

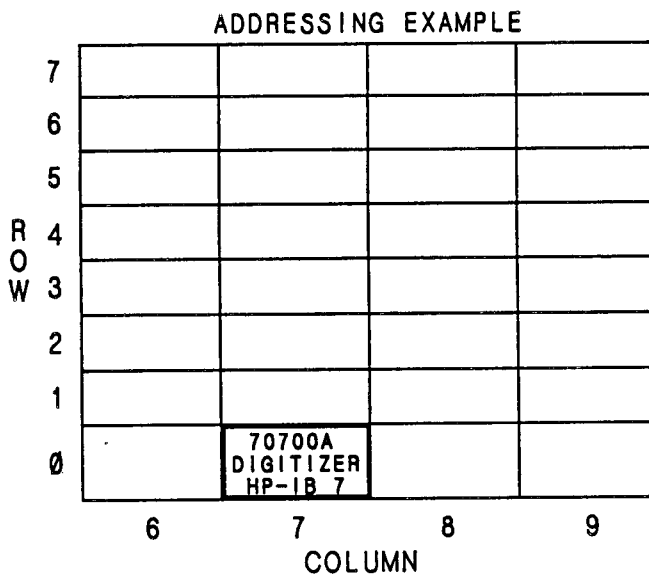

THE HP 70001A MAINFRAME DOES NOT HAVE AN HP-MSIB ADDRESS. THE USUAL ADDRESS FOR THE HP 70205A OR HP 70206A DISPLAY IS ROW 0, COLUMN 4.

CABLE CONNECTION EXAMPLE

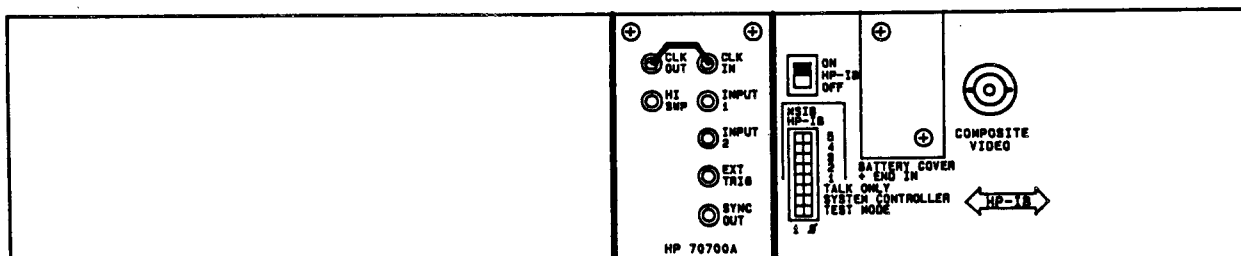

2. MODULES CAN BE CONFIGURED IN ANY ORDER, PROVIDED THE CABLES ARE CONNECTED TO THE CORRECT INPUTS AND OUTPUTS. FOR APPROPRIATE CABLES, REFER TO REPLACEABLE SYSTEM PARTS IN THE TROUBLESHOOTING CHAPTER. CABLE LENGTHS MUST BE KEPT AS SHORT AS POSSIBLE IN A SYSTEM WITH AN HP 70700A DIGITIZER.

Figure 2-4. Single-Digitizer System

NOTE

Digitizer cables must be kept as short as possible for correct operation of the HP 70700A Digitizer. A cable length of 12 inches is the recommended maximum.

In a multiple-digitizer system, the length of the cables connecting CLK OUT and CLK IN must be the same for each of the modules. In Figure 2-5, for example, CLK OUT of the master is connected to both its own CLK IN and to the CLK IN inputs of two slaves. Each of the three input cables (from the "tee" connector to the CLK IN inputs) must be the same length.

The same considerations apply when connecting SYNC OUT of the master to the EXT TRIG input of the slaves. In Figure 2-5, SYNC OUT of the master is connected, through a "tee" connector, to the EXT TRIG inputs of two slaves. Both of the cables must be the same length.

NOTE

If the cable lengths are not matched properly, or are too long, instrument performance may be degraded.

Refer to Chapter 5 for ordering information for the "tee" connectors and cables.

NOTE

Multiple-digitizer systems with from two to four channels may be controlled over the front panel of the display. Multiple-digitizer systems with more than four channels must be controlled over HP-IB with an external controller with IEEE-488 interface bus capability (i.e., HP-IB).

SYSTEM COMPONENTS:

- HP 70001A MAINFRAME
- HP 70205A GRAPHICS DISPLAY
- HP 70700A DIGITIZER
- HP 70700A DIGITIZER
- HP 70700A DIGITIZER

ADDRESSING EXAMPLE

7				
6				
5				
4				
3				
2		70700A DIGITIZER		
1		70700A DIGITIZER		
0		70700A DIGITIZER HP-IB 7		
	6	7	8	9

NOTES:

1. THE CHANNEL ASSIGNED TO EACH HP 70700A DIGITIZER DEPENDS UPON ITS ADDRESS. REFER TO THE HP-MSIB/HP-IB ADDRESSING CHAPTER FOR MORE INFORMATION.

THE HP 70001A MAINFRAME DOES NOT HAVE AN HP-MSIB ADDRESS. THE USUAL ADDRESS FOR THE HP 70205A OR HP 70206A DISPLAY IS ROW 0, COLUMN 4.

CABLE CONNECTION EXAMPLE

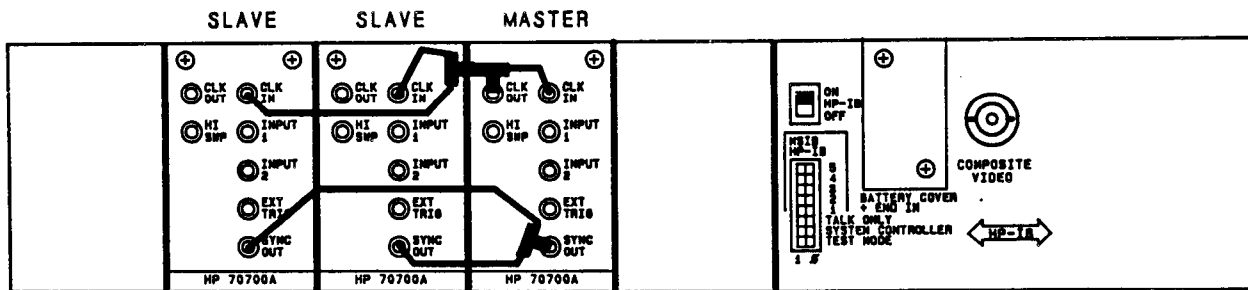

2. MODULES CAN BE CONFIGURED IN ANY ORDER, PROVIDED THE CABLES ARE CONNECTED TO THE CORRECT INPUTS AND OUTPUTS. CABLE LENGTH CAN AFFECT THE PERFORMANCE OF THE DIGITIZER SYSTEM. REFER TO THE CABLE SELECTION INFORMATION IN THE INSTALLATION CHAPTER. FOR APPROPRIATE CABLES AND CONNECTORS, REFER TO THE REPLACEABLE SYSTEM PARTS INFORMATION IN THE TROUBLESHOOTING CHAPTER.

Figure 2-5. Multiple-Digitizer System

SYSTEM COMPONENTS:

HP 70700A DIGITIZER
 HP 71100A SPECTRUM ANALYZER SYSTEM,
 STD., WHICH CONSISTS OF:

- HP 70001A Mainframe
- HP 70205A Graphics Display
- HP 70900A Local Oscillator
- HP 70902A IF Section
- HP 70904A RF Section

NOTES:

1. TO RUN THE SYSTEM DIAGNOSTICS PROGRAM ON THIS SPECTRUM ANALYZER, THE HP-MSIB ADDRESSES MUST BE IN A SPECIFIC ORDER. SEE SYSTEM DIAGNOSTICS UNDER THE TROUBLESHOOTING TAB OF THE HP 70900A LOCAL OSCILLATOR INSTALLATION AND VERIFICATION MANUAL.
2. REFER TO THE GENERAL INFORMATION CHAPTER FOR INFORMATION ABOUT SOFTWARE/FIRMWARE COMPATIBILITY.

ADDRESSING EXAMPLE

R O W	7				
	6				
	5				
	4		70904A RF SECT		
	3				
	2		70700A DIGITIZER		
	1		70902A IF SECT		
	0		70900A LO/CTLR HP-1B1B		
		17	18	19	20
		C O L U M N			

THE HP 70001A MAINFRAME DOES NOT HAVE AN HP-MSIB ADDRESS. THE USUAL ADDRESS FOR THE HP 70205A OR HP 70206A DISPLAY IS ROW 0, COLUMN 4.

CABLE CONNECTION EXAMPLE

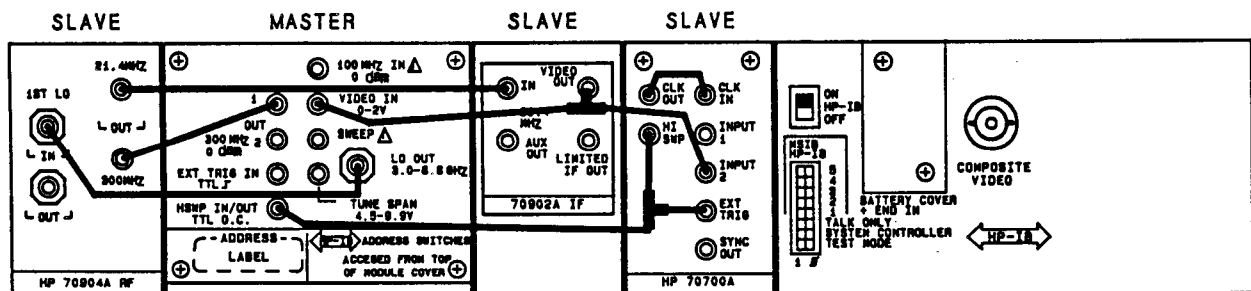

3. MODULES CAN BE CONFIGURED IN ANY ORDER, PROVIDED THE CABLES ARE CONNECTED TO THE CORRECT INPUTS AND OUTPUTS. FOR APPROPRIATE CABLES, REFER TO REPLACEABLE SYSTEM PARTS UNDER THE TROUBLESHOOTING TAB OF THE HP 70900A LOCAL OSCILLATOR INSTALLATION AND VERIFICATION MANUAL (FOR SPECTRUM ANALYZER-RELATED CABLES), OR THE HP 70700A DIGITIZER INSTALLATION AND VERIFICATION MANUAL (FOR DIGITIZER-RELATED CABLES).

Figure 2-6. Digitizer Slave in a Spectrum Analyzer System

SYSTEM COMPONENTS:

HP 70700A DIGITIZER
 HP 71100A SPECTRUM ANALYZER SYSTEM,
 STD., WHICH CONSISTS OF:

- HP 70001A Mainframe
- HP 70205A Graphics Display
- HP 70900A Local Oscillator
- HP 70902A IF Section
- HP 70904A RF Section

ADDRESSING EXAMPLE:

7		...	
6		...	
5		...	
4		...	70904A RF SECT
3		...	
2		...	
1		...	70902A IF SECT
0	70700A DIGITIZER HP-1B7	...	70900A LO/CTLR HP-1B18
	6	7	...
			18
			COLUMN

NOTES:

1. TO RUN THE SYSTEM DIAGNOSTICS PROGRAM ON THIS SPECTRUM ANALYZER, THE HP-MSIB ADDRESSES MUST BE IN A SPECIFIC ORDER. SEE SYSTEM DIAGNOSTICS UNDER THE TROUBLESHOOTING TAB OF THE HP 70900A LOCAL OSCILLATOR INSTALLATION AND VERIFICATION MANUAL.

THE HP 70001A MAINFRAME DOES NOT HAVE AN HP-MSIB ADDRESS. THE USUAL ADDRESS FOR THE HP 70205A OR HP 70208A DISPLAY IS ROW 0, COLUMN 4.

CABLE CONNECTION EXAMPLE

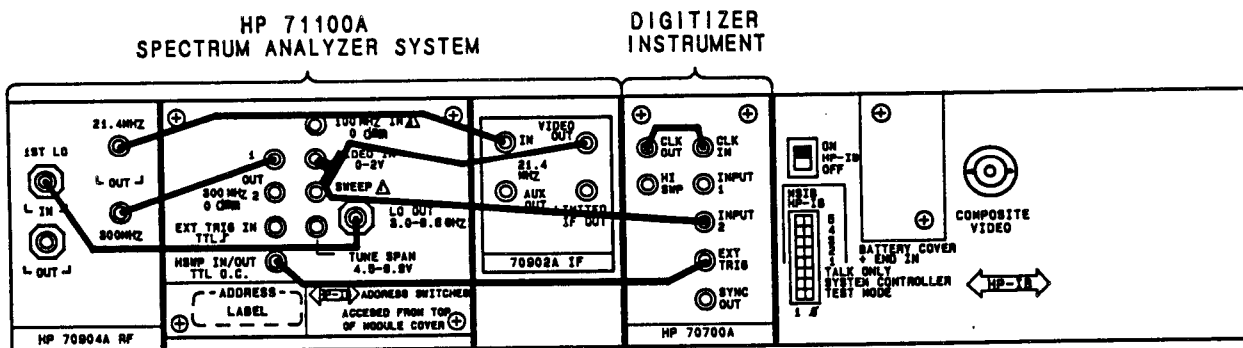

2. MODULES CAN BE CONFIGURED IN ANY ORDER, PROVIDED THE CABLES ARE CONNECTED TO THE CORRECT INPUTS AND OUTPUTS. FOR APPROPRIATE CABLES, REFER TO REPLACEABLE SYSTEM PARTS UNDER THE TROUBLESHOOTING TAB OF THE HP 70900A LOCAL OSCILLATOR INSTALLATION AND VERIFICATION MANUAL (FOR SPECTRUM ANALYZER-RELATED CABLES), OR THE HP 70700A DIGITIZER INSTALLATION AND VERIFICATION MANUAL (FOR DIGITIZER-RELATED CABLES).

Figure 2-7. Digitizer Instrument with a Spectrum Analyzer System

HP-MSIB/HP-IB ADDRESSING

HP 70000 Modular Measurement Systems are made up of separate parts called elements. All elements communicate over the HP-MSIB. To communicate and function properly, all elements must have appropriate HP-MSIB addresses.

HP-MSIB addressing is not the same as HP-IB addressing. Given below are definitions of essential terms, and explanations of the three main subjects you must understand to set the HP-MSIB and HP-IB addresses of an element:

- **Modular Measurement System Terms**
- **Address Matrix**
- **Address Protocol**
- **Address Switches**

MODULAR MEASUREMENT SYSTEM TERMS

Understanding the following terms is essential to understanding HP-MSIB addressing and the structural relationship of modular measurement system devices.

Functional Terms

Functional terms refer to the types of function, or work, that a given device may perform in a system and to the interrelationships (e.g., master or slave) that occur among the devices in a system.

Element: Any device (e.g., HP 70902A IF Section) that communicates over the HP-MSIB. In contrast, the HP 70001A Mainframe controls all HP-MSIB communication, but does not communicate over the HP-MSIB and therefore is not an element.

Slave: An element that is controlled by another element.

Master: An element that controls other elements.

Independent element: An element that is neither a master nor a slave (e.g., a display).

Instrument: An independent element, a master element, or a master with slaves, that performs an independent function.

Structural Terms

Structural terms refer to the hardware type of the device.

Mainframe: A device designed for modules to plug into. The mainframe supplies power, and HP-IB and HP-MSIB interconnections for the modules, in addition to controlling HP-MSIB communication.

Module: A plug-in designed to work in a Hewlett-Packard modular measurement system mainframe.

Stand-Alone Instrument: An element that can function without being plugged into a mainframe (e.g., HP 70206A System Graphics Display).

ADDRESS MATRIX

The address matrix (see Figure 2-8) is a graphic representation of the addresses available on the HP-MSIB and the relationships among elements (i.e., master/slave). The placement of an element on the address matrix is one of the factors that determines whether the element will have HP-IB access and can respond to display queries. (Illustrations of the physical switches used to set these addresses are given in Address Switches later in this section.)

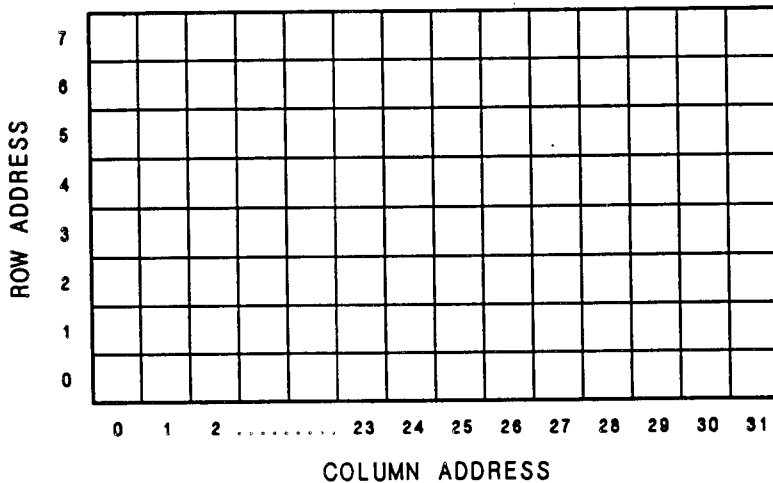

Figure 2-8. Address Matrix

To allow the elements to communicate and function properly, each element must have a binary eight-bit HP-MSIB address that is appropriately positioned on the address matrix. Every element in a system must have a unique address. The three most significant bits (MSB) of the HP-MSIB address determine the row address; the five least significant bits (LSB) determine the column address (see Figure 2-8). The decimal equivalents of the binary row and column addresses are used throughout this documentation. For example:

	Row	Column
Binary	(MSB)→ 010	11000 ←(LSB)
Decimal	2	24

There are 8 possible row addresses and 32 possible column addresses. Address 0, 31 (row, column) is an illegal address, leaving 255 HP-MSIB addresses available.

HP-IB Access Area

The HP-IB access area on the address matrix is row 0 (except address 0, 31). Elements that have been designed for HP-IB access will be able to communicate on HP-IB only if they are addressed at row address 0 in the HP-IB access area.

Display-Response Area

When there is a display on the HP-MSIB, a display-response area exists at row address 0 of the address matrix. Only elements that have been designed to interface with the display and report errors (e.g., HP 70700A Digitizer and HP 70900A Local Oscillator) should be addressed at row address 0.

NOTE

If an element that does not have these capabilities is addressed at row address 0, the system will cease to communicate.

Display Communication Capabilities

Before an element can communicate with the display it must have a display window, or keyboard, assigned. This provides a link for communication between the display and the element.

A display can be assigned to any element at a legal address, that has been designed with the capability to interface with the display and report errors. Master elements such, as the HP 70700A Digitizer and HP 70900A Local Oscillator, are examples of elements designed with this capability.

An element that is addressed at row address 0, and has a display assigned to it, can use both the automatic error-reporting routine and the *REPORT ERRORS* softkey to report errors to the display. To assign a display to an element at row address 0, press [DISPLAY], then *SELECT INSTR*. This automatically assigns the display to the element with the lowest HP-MSIB column address. Use the [↑] key to select an element with a higher HP-MSIB column address.

A display can be assigned to an element that is at an address other than row address 0. However the element will not be able to use the *REPORT ERRORS* softkey to report errors to the display. It will be able to use the automatic error-reporting routine. To assign a display to an element that is at an address other than row address 0, use the *assign keybd*, *assign window* or *ALLOC DISPLAY* softkeys in the Display menus to gain a display link. For example, to use the *ALLOC DISPLAY* softkey, press [DISPLAY], then *address map*. After using the front-panel knob, or [↑] and [↓] keys, to select the element to which you want to assign the display, press *ALLOC DISPLAY*.

ADDRESS PROTOCOL

Below is addressing information for two categories of elements: master/slave and independent. An element that controls another is called a master. An element that is controlled by another is called a slave. Some elements are neither controlled nor controllers; they are independent.

Master/Slave Elements

A master may be placed at any legal address; however, it must be placed at row 0 to have HP-IB access and full error-reporting capabilities. The slave elements that a master controls must be in the master's slave area.

The slave area of the master is the area the master controls on the address matrix. (See Figure 2-9.) To determine its slave area, the master searches for an element that defines the boundaries of the slave area.

The master starts searching at its own address column, which is one row above its row address. It searches up the column until it reaches the top. Then it continues the search one column address higher, starting at its own row address. For example, master M1 in Figure 2-9 would start searching at row 1, column 23, one row above its address. When it reaches the top of column 23, it searches up column 24, starting at row address 0. The search continues until the master either finishes searching the entire address matrix or finds the defining element.

Digitizer Channel Number Assignment is determined by address. The master digitizer, at row 0, will always be assigned as CHANNEL 1. The next HP 70700A encountered by the master in its search will be assigned as CHANNEL 2. This process continues until all of the channels have been assigned or until all of the HP 70700A Digitizers have been assigned channels. A maximum of four channels are available when a digitizer system is controlled from the front panel. A maximum of eight channels are available when the system is controlled by a computer.

The Defining Element for a system is an element which meets the following requirements:

1. It must be in a column that is greater than the column address of the master. In Figure 2-9, the master is in column 23, so the defining element for this master must be in column 24 or above.
2. It must be in a row that is the same as or less than the row address of the master. In Figure 2-9, the master is in row 0, so the defining element for this master must be in row 0.

For the master shown at row 0, column 23 in Figure 2-9, the defining element is at row 0, column 29.

If there is no defining element, the right-side boundary of the slave area extends to and includes column 31.

NOTE

If a display is on the HP-MSIB, and the system master is addressed at row address 0, the defining element must have been designed to be addressed in the display response area. When there is a display on the HP-MSIB, the system may cease communication if an element not designed for use in the display response area is addressed there.

The **Slave Area Boundaries** are defined once the master finds either a defining element or address 7, 31 (the last address in the matrix). The master sets the slave area boundaries using the criteria below:

1. The left-side boundary equals the column address of the master. In Figure 2-9 this is column 23.
2. The right-side boundary equals a column address one less than the column address of the defining element. In Figure 2-9 this is column 28. If there is no defining element, the side boundary extends to and includes column 31.
3. The bottom boundary is always one row greater than the row address of the master. In Figure 2-9 this is row 1.
4. The top boundary is the top of the matrix (row 7).

If a new element is added to the area labeled "No Element Present" in Figure 2-9, this element becomes the new defining element and the right-side boundary will move toward the master.

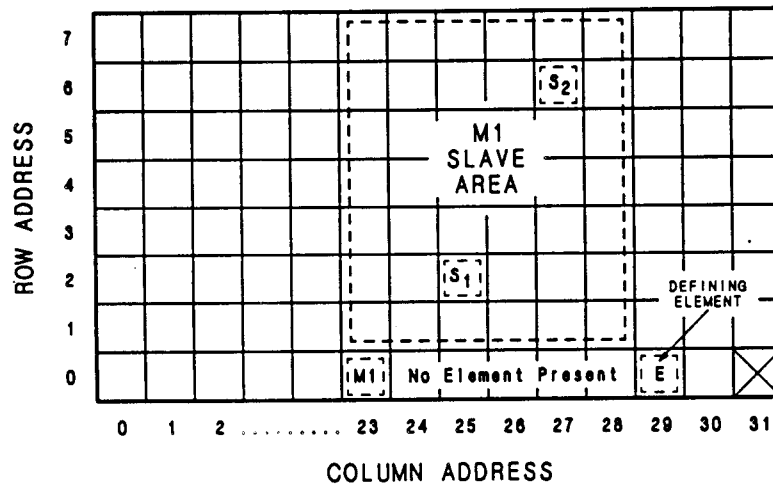

Figure 2-9. Master/Slave Addressing

Independent Elements

Independent elements, such as displays, function neither as masters nor as slaves. Independent elements are considered separate instruments.

Because displays do not have row address switches, they automatically default to a row address of 0. The usual address for a display is row 0, column 4.

ADDRESS SWITCHES

The address switches set the HP-MSIB address of an element; the column switches also set the HP-IB address for masters and independent elements. Some master elements and displays can also have their HP-IB address set through the use of softkeys (i.e., soft-set address). The instructions for entering a soft-set HP-IB address are given after the descriptions of the (hard) address switches.

INSTALLATION

The address switches (see Figures 2-10 and 2-11) are located on the top, side, or rear of the modules, and the rear of the HP 70206A System Graphics Display.

Descriptions of the address switches are given below.

HP 70700A Address Switches

The HP 70700A Digitizer address switches are located on the top of the module.

HP-IB ON-OFF When this is set to OFF, the HP 70700A Digitizer is switched off the HP-IB.

Column ADDRESS Switches 1-5 These set the HP-MSIB column address, which is also the HP-IB address.

Row ADDRESS Switches 1-3 These set the HP-MSIB row address.

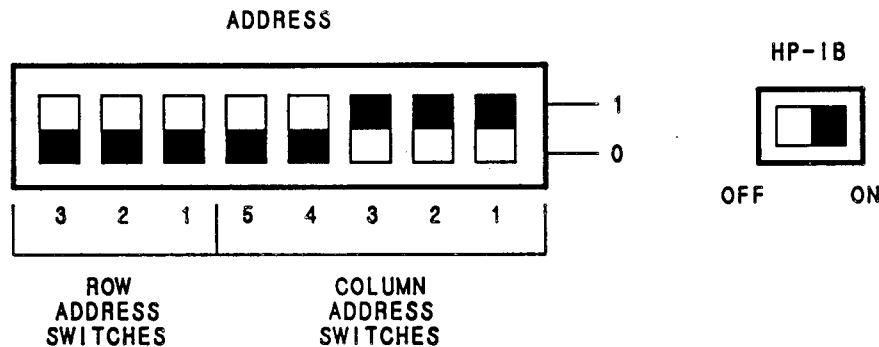

Figure 2-10. Address Switches — HP 70700A

Display Address Switches

HP-IB ON/OFF This switches the display on or off the HP-IB without disrupting instrument operation.

A6-A8 or MSIB ROW This shows that the default HP-MSIB row address is (0).

A1-A5 HP-IB/HP-MSIB These address switches set the HP-MSIB column address, which is also the HP-IB address.

TALK ONLY When this is set to 1 (on), the display can talk on the HP-IB without requiring a reply (some plotters cannot reply). In normal operation, this switch is set to 0 (off).

SYSTEM CONTROLLER When this is set to 1 (on), the display functions as a controller on the HP-IB bus. In normal operation, the switch is set to 0 (off).

TEST MODE When this is set to 1 (on), the display goes into a special test mode at instrument power-on. In normal operation, the switch is set to 0 (off).

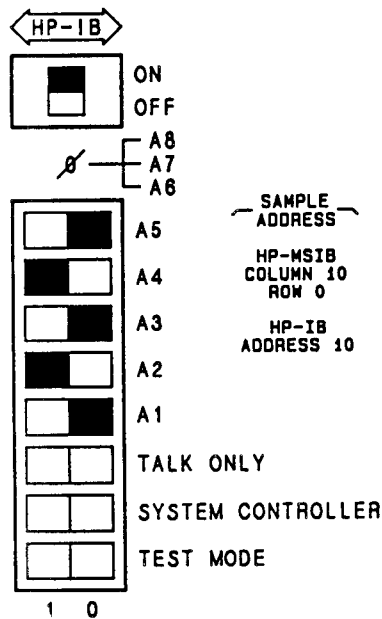

Figure 2-11. Address Switches — Display

Soft-Set HP-IB Addresses

The HP-IB address of many masters and displays can, under certain conditions, be set from the front panel of a display. At startup, the soft-set address will override the address switch settings. The soft-set address remains until the (hard) address switches are reset, or until another soft-set address is entered.

Use the following procedure to enter a soft-set HP-IB address:

1. Press [DISPLAY] on the display front panel.
2. When the menu appears, press *address map*.
3. When the next menu appears, select the appropriate master or display, using the display front-panel knob or [↑] and [↓] keys.
4. Press *SET HP-IB*.
5. Enter the new HP-IB address, using the numeric keys on the display front panel.
6. Press *ENTER*.

CONTENTS

Chapter 3. Specifications	3-1
Specifications versus Characteristics	3-1
Module Specifications	3-2
HP 70700A Digitizer	3-2
HP 70001A Mainframe	3-6
HP 70205A Graphics Display	3-7
HP 70206A System Graphics Display	3-8
System Specifications	3-9
HP 71100A System with HP 70700A As Slave	3-9
HP 71200A, HP 71201A, or HP 71210A Systems with HP 70700A As Slave	3-10
HP 71300A System with HP 70700A As Slave	3-11

Chapter 3

SPECIFICATIONS

This chapter contains two types of specifications:

- **Module Specifications** include characteristics and measurement-related specifications for the HP 70700A Digitizer. They also include specifications and characteristics for the displays and mainframe that can be used with an HP 70700 Digitizer in a digitizer system.
- **System Specifications** include only the specifications that are modified when using the HP 70700A Digitizer in a predefined HP 70000A Modular Measurement System (e.g., HP 71100A RF Spectrum Analyzer System).

The HP 70700A Digitizer Performance Test program is used to verify whether system performance meets specifications. Refer to Chapter 4 for information on running the program.

SPECIFICATIONS VERSUS CHARACTERISTICS

Specifications and characteristics are listed together. Characteristics are identified with the words *characteristic only*.

Specifications

Specifications describe warranted performance over the temperature range of 0°C to +55°C after one hour of continuous operation (unless otherwise noted).

Unless otherwise noted, where specifications are subject to minimization with error correction routines, corrected limits are given.

Characteristics

Characteristics provide useful information by giving functional, but non-warranted, performance parameters.

MODULE SPECIFICATIONS

This section lists only characteristics and measurement-related specifications (i.e., common specifications that apply to making measurements) for the following elements and mainframe:

- HP 70700A Digitizer
- HP 70001A Mainframe
- HP 70205A Graphics Display
- HP 70206A System Graphics Display

HP 70700A DIGITIZER

Specifications

Analog Input:

Analog (3 dB) bandwidth:
 Input 1 >35 MHz
 Input 2 >35 MHz

Damage Level:

1 M Ω input impedance $\pm 12V$ above 1 kHz, ± 40 below 1kHz
 50 Ω input impedance 5V rms

Isolation between Inputs 1 and 2 >40 dBc at 10 MHz
 (with input coupling set to dc 50 Ω)

Gain accuracy $\pm 1\%$
 (after recalibration at operating temperature)

Gain accuracy without recalibration $\pm 1\% + 0.03\%/^{\circ}C$

Offset Accuracy $\pm 1\%$
 (after recalibration at operating temperature)

Offset Accuracy without recalibration $\pm 1\% + 0.1\%/^{\circ}C$

Digitizing Performance:

Resolution 10 bits; 1 part in 1024

Internal reference 20 MHz $\pm 0.01\%$

Effective number of bits* ≥ 7.5 at 1 MHz (with $\pm 1V$ sine wave)
 ≥ 7.0 at 10 MHz (with $\pm 1V$ sine wave)

Harmonic and spurious distortion > 50 dBc at 1 MHz (with $\pm 1V$ sine wave)
 > 45 dBc at 10 MHz (with $\pm 1V$ sine wave)

Data Storage:

Memory size 262,144 10-bit samples

Record length 20 to 261,888 10-bit samples

General:

Temperature:

Operating 0 to 55°C

Storage -40 to +70°C

Humidity:

Operation 0 to 95% at +40°C

EMI:

Conducted and radiated interference is in compliance with CISPR publication 11 (1975) and
 Messemphaenger-Postverfuegung 526/527/79 (Kennzeichnung Mit F-Nummer/Funkschutzzeichen).
 Radiated interference is in compliance with MIL-STD 461B, Part 7, RE02.

Warm-up time 15 minutes, from cold start

Power and cooling requirements provided by the HP 70000 Series mainframe

Net weight (*characteristic only*) 2.2 kg (4.9 lbs)

Dimensions 1/8-width module

Supplemental Characteristics

Multi-channel configurability

Number of channels per HP 70700A module one

Maximum number of channels with display control four

Maximum number of channels with external controller eight**

Multi-channel sampling synchronous

Digitizer performance in multi-channel system same as for single channel

* The effective number of bits specification is a measure of dynamic performance. Refer to HP Product Note 5180A-2, "Dynamic Performance Testing of A to D Converters" for more information.

** More channels can be configured into a system if some external circuitry is provided. Consult factory.

SPECIFICATIONS

Programmability

Fully programmable via HP-IB
Based on the proposed standard, "IEEE-488.2—Codes, Formats, Protocols and Common Commands".

Analog Input

Selection: Two analog inputs, one active at any time.

Connectors:

	Input 1	Input 2
Front Panel	BNC (f)	(none)
Rear Panel	SMB (f)	SMB (f)

Input coupling and impedance: Selectable via softkeys (manual operation) or under program control (remote operation), as follows:

Coupling/Resistance	Capacitance	
	Input 1	Input 2
AC, 1 M Ω	60 pF	45 pF
DC, 1 M Ω	60 pF	45 pF
DC, 50 Ω	60 pF	45 pF

Input ranges (full scale) $\pm 0.3V, \pm 1V, \pm 3V, \pm 10V$.

Maximum sensitivity 0.5 mV/LSB on the $\pm 0.3V$ range

Input offset voltage $\pm 100\%$ of attenuator range in 1% steps

Probe selection 1 \times , 10 \times , or 50 \times

Timebase

External reference input: 10 to 20 MHz; TTL level; positive and negative widths must each be greater than 24 ns.

Available sampling rates: R/N , where R is the reference frequency and N is an integer between 1 and 2^{23} , inclusive.

Dual Timebase: second timebase is switched in after $8N$ samples, where N is between 1 and 32,768, inclusive.

Random-Event Capture: Each time a trigger is received, a record of data (consisting of a predetermined number of pre- and post-trigger samples) is recorded in a different segment of memory. No re-arm time is required between triggers. The relative times of the triggers are recorded with a precision of one sample period. Either the absolute or the relative times of the triggers may be examined with or without reading the data. The total number of records of data that can be captured depends on the size of the records and the mode of operation, and is typically several hundred. The maximum allowable time between triggers is 22 minutes at a sampling rate of 20 megasamples/second and using the smallest possible record size (worst-case conditions).

Equivalent Time Sampling: A detailed record of a periodic waveform is constructed from sparse samples collected over many periods. For Equivalent Time Sampling to function, the periodic waveform must be jitter-free, the pulse width must be greater than one sample period, and the fundamental frequency must not be an integer-submultiple of the reference frequency.

Data Storage and Transfer

Waveform registers: Four 512-point waveform registers are available for storage, display, and trace math.

Maximum data transfer rate: 60 kbyte/s (depends on receiving instrument)

Triggering

Source: Channel 1, external, line and none (free running)

Trigger timing uncertainty (without interpolation): 50 ns

Internal triggering modes: Trigger when waveform passes through a level (positive, negative, or either slope); trigger when waveform goes above a level, below a level, or outside a range.

External triggering modes: TTL level (positive, negative, or either edge)

Triggering Parameters:

Holdoff: The amount of time the module will wait before re-arming the trigger, adjustable between 0 and 10,000 seconds in 10 ms steps.

Hysteresis: Adjustable in 1% steps (available in level/slope triggering only)

External trigger input: TTL level; impedance is equivalent to one 74AS TTL load.

Pre- and post-trigger data: A "trace" or record of samples may be aligned anywhere in the interval $[K - 2^{18}, K + 2^{20}]$, where K is the index of the sample corresponding to the trigger.

Display features (requires HP 70000 Series display)

Screen modes: full/split

Background: Grid, frame or axes

Trace display modes: Dot mode (each sample point is represented by a dot); line mode (adjacent sample point dots are connected by line segments).

Interpolation: The sampling density is increased by digital processing. Zeroes are inserted between samples, and the resulting unsampled waveform is then digitally lowpass-filtered. The available lowpass filters are: Gaussian (gradual rolloff), and brickwall (sharp cutoff).

Detection sampling modes: A subsampled waveform is obtained by dividing the time axis into uniform intervals, and retaining from each the maximum or minimum value of the original sampled waveform. The available modes are conventional sampling (sample detection), positive peak detection, negative peak detection, and alternate peak detection.

SPECIFICATIONS

Frequency mode: An FFT (fast Fourier transform) is computed of the trace currently being displayed. The magnitude (in dB) of the transform is displayed as a function of frequency. The available FFT sizes are 32, 64, 128, . . . , 1024 points. Nevertheless, the number of points displayed in frequency domain is not restricted to be a power of two; intermediate sizes are obtained through sample rate conversion in the frequency domain. The available windows are Hanning, flat-top, and uniform.

Other display features: Time and voltage markers; trace averaging.

Automatic measurement and analysis

Auto-scale: Adjusts sampling rate and input attenuation levels to match the characteristics of the input signal.

Automatic pulse parameter measurements: Rise time, fall time, duration of positive or negative portion of pulse, duty cycle, period, fundamental frequency, pre-shoot, over-shoot, peak-to-peak voltage, RMS voltage.

Waveform math functions: Point-by-point trace addition, subtraction, multiplication, and computation of additive inverse. Operands may be selected from the channels and trace memories.

HP 70001A MAINFRAME

General

Temperature:	
operation	0 °C to +55 °C
storage	-40 °C to +75 °C
Humidity:	
operation	0 to 95% relative humidity at +40 °C
EMI:	
Conducted and radiated interference is in compliance with CISPR publication 11 (1975) and Messemphaenger-Postverfuegung 526/527/79 (Kennzeichnung Mit F-Nummer/Funkschutzzeichen).	
Radiated interference is in compliance with MIL-STD 461B, Part 7, RE02.	
Line Voltage	100, 120, 220, and 240 Vac (+5%, -10%)
Line Frequency:	
standard	47-66 Hz
Option 400	356-444 Hz
Power consumption	650 VA maximum
Warm-up time:	
One hour warm-up from cold start	0 °C to 55 °C
Weight (<i>characteristic only</i>)	14.5 kg (31.9 lb)

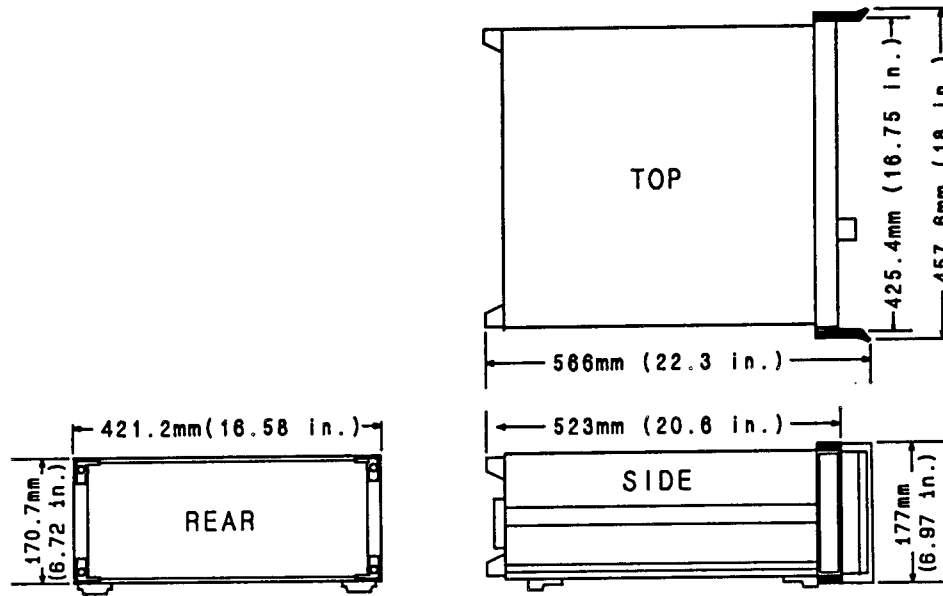

Figure 3-1. Physical Dimensions (Characteristic Only)

HP 70205A GRAPHICS DISPLAY

The HP 70205A Graphics Display is 3/8-width module that is also an independent element. It has the following measurement-related specifications.

Outputs

Composite Video

Horizontal frequency	24 kHz \pm 1%
Signal level:	
into 75 Ω load	1V p-p \pm 10%
Refresh rate	60 Hz \pm 1%
Bandwidth	25 MHz
Connector	BNC (f)

General

Temperature:	
operation	0 $^{\circ}$ C to +55 $^{\circ}$ C
storage	-40 $^{\circ}$ C to +75 $^{\circ}$ C
Humidity:	
operation	0 to 95% relative humidity at +40 $^{\circ}$ C

SPECIFICATIONS

EMI:

Conducted and radiated interference is in compliance with CISPR publication 11 (1975) and Mesempfaenger-Postverfuegung 526/527/79 (Kennzeichnung Mit F-Nummer/Funkschutzzeichen).
Radiated interference is in compliance with MIL-STD 461B, Part 7, RE02.

Power and cooling requirements:

Power and cooling are provided by the HP 70000 Series mainframe

Warm-up time:

One hour warm-up from cold start 0°C to 55°C

Weight (*characteristic only*) 5.1 kg (11.2 lb)

Dimensions 3/8-width module

HP 70206A SYSTEM GRAPHICS DISPLAY

The HP 70206A System Graphics Display is an independent element that is also a stand-alone instrument (it does not plug into an HP 70000 Series mainframe). It has the following measurement-related specifications.

Inputs and Outputs

Composite Video

Horizontal frequency 24 kHz \pm 1%

Signal level (into 75 Ω load) 1V p-p \pm 10%

Refresh rate 60 Hz \pm 1%

Bandwidth 25 MHz

Connector BNC (f)

General

Temperature:

operation 0°C to +55°C

storage -40°C to +75°C

Humidity:

operation 0 to 95% relative humidity at +40°C

EMI:

Conducted and radiated interference is in compliance with CISPR publication 11 (1975) and Mesempfaenger-Postverfuegung 526/527/79 (Kennzeichnung Mit F-Nummer/Funkschutzzeichen).
Radiated interference is in compliance with MIL-STD 461B, Part 7, RE02.

Line Voltage 100, 120, 220, and 240 Vac (+5%, -10%)

Line Frequency:

standard 47-66 Hz

Option 400 356-444 Hz (100, 120 Vac only)

Option 401 356-444 Hz (100, 120 Vac only)

Power consumption 300 VA maximum

Warm-up time:

One hour warm-up from cold start 0°C to 55°C

Weight (*characteristic only*) 18.6 kg (41 lb)

Dimensions (*characteristic only*):

See Figure 3-1, Physical Dimensions (Characteristic Only)

SYSTEM SPECIFICATIONS

This section lists **only** the system specifications that are modified when an HP 70700A Digitizer is used as a slave in a non-digitizer system.

The modified system specifications are given in the following order:

- HP 71100A RF Spectrum Analyzer System with HP 70700A Digitizer as slave
- HP 71200A, HP 71201A, or HP 71210A Spectrum Analyzer Systems with an HP 70700A Digitizer as slave
- HP 71300A Millimetre Spectrum Analyzer with an HP 70700A Digitizer as slave

HP 71100A SYSTEM WITH HP 70700A AS SLAVE

The following changes to standard system specifications need to be made:

SWEEP

SWEEP TIME*

Range

Zero span	80 μ s to 335s with traces of 800 points**
Swept span	15 ms to 335s with traces of 800 points**

FREQUENCY

FREQUENCY SPAN

Accuracy

Span \leq 10 MHz	\pm [1% of span + (span \times freq ref accuracy)]
Span >10 MHz	\pm (5% of span)

FREQUENCY READOUT ACCURACY

Span \leq 10 MHz	\pm [(freq readout \times freq ref accuracy) + 1% of span + 10 Hz]
Span >10 MHz	\pm [(freq readout \times freq ref accuracy) + 2% of span + 10 Hz]

* A sweep time accuracy of \pm 2% is ensured if **one** of the following conditions is met:

$$\begin{aligned} &\text{Sweep time} \geq (\text{trace length} \times 5.0 \mu\text{s}) \\ &\text{or Sweep time} = (n \times \text{trace length} \times 100 \text{ ns}) \\ &\quad (\text{where } n \text{ is an integer}) \end{aligned}$$

** Faster sweep times are available when traces of less than 800 points are defined.

SPECIFICATIONS

AMPLITUDE ACCURACY

DIGITIZATION RESOLUTION 0.4 dB

HP 71200A, HP 71201A, OR HP 71210A SYSTEMS WITH HP 70700A AS SLAVE

The following changes to standard system specifications need to be made:

SWEEP

SWEEP TIME*

Range

Zero span 80 μ s to 335s with traces of 800 points**
Swept span 15 ms to 335s with traces of 800 points**

FREQUENCY

FREQUENCY SPAN

Accuracy

Span ≤ 10 MHz $\times N$ $\pm [1\%$ of span + (span \times freq ref accuracy)]
Span > 10 MHz $\times N$ $\pm (5\%$ of span)
(where N is the harmonic mixing band number)

FREQUENCY READOUT ACCURACY

Span ≤ 10 MHz $\times N$ $\pm [($ freq readout \times freq ref accuracy) + 1% of span + 10 Hz]
Span > 10 MHz $\times N$ $\pm [($ freq readout \times freq ref accuracy) + 2% of span + 10 Hz]
(where N is the harmonic mixing band number)
Span > 200 MHz*** $\pm [($ freq readout \times freq ref accuracy) + 5% of span + 10 Hz]

AMPLITUDE ACCURACY

DIGITIZATION RESOLUTION 0.4 dB

* A sweep time accuracy of $\pm 2\%$ is ensured if **one** of the following conditions is met:

Sweep time \geq (trace length $\times 5.0$ μ s)
or Sweep time = (n \times trace length $\times 100$ ns)
(where n is an integer)

** Faster sweep times are available when traces of less than 800 points are defined.

*** For band-crossing situations

HP 71300A SYSTEM WITH HP 70700A AS SLAVE

The following changes to standard system specifications need to be made:

SWEEP

SWEEP TIME*

Range

Zero span	80 μ s to 335s with traces of 800 points**
Swept span	15 ms to 335s with traces of 800 points**

FREQUENCY

FREQUENCY SPAN

Accuracy

Span ≤ 10 MHz \times N	$\pm[1\%$ of span + (span \times freq ref accuracy)]
Span > 10 MHz \times N	$\pm(5\%$ of span)

(where N is the harmonic mixing band number)

FREQUENCY READOUT ACCURACY

Span ≤ 10 MHz \times N:

$\pm[(\text{freq readout} \times \text{freq ref accuracy}) + 1\%$ of span + (300 Hz or 35% of Res BW, whichever is greater)]

Span > 10 MHz \times N:

$\pm[(\text{freq readout} \times \text{freq ref accuracy}) + 2\%$ of span + (300 Hz or 35% of Res BW, whichever is greater)]

(where N is the harmonic mixing band number)

AMPLITUDE ACCURACY

DIGITIZATION RESOLUTION 0.4 dB

* A sweep time accuracy of $\pm 2\%$ is ensured if **one** of the following conditions is met:
 Sweep time \geq (trace length \times 5.0 μ s)
 or Sweep time = (n \times trace length \times 100 ns)
 (where n is an integer)

** Faster sweep times are available when traces of less than 800 points are defined.

CONTENTS

Chapter 4. Verification	4-1
Required Test Equipment	4-2
Standard Test Equipment	4-2
Specialized Test Equipment	4-3
Performance Test Software	4-6
Introduction	4-6
Operation	4-7
Measurement Uncertainty	4-14
Installation/Configuration	4-16
Main Menu	4-19
Mass Storage Menu	4-20
Parameter Menu	4-21
Equipment Menu	4-23
HP-MSIB Map Screen Menu	4-26
Test Menu	4-26
Error Messages	4-29
Test Descriptions	4-31
Test List	4-31
1. Effective Number of Bits	4-31
2. Distortion	4-32
3. Gain Accuracy	4-33
4. Offset Accuracy	4-33
5. Frequency Response	4-34
6. Input Isolation	4-35
7. Reference Clock Accuracy	4-36
8. Random-Event Capture	4-37
9. External Trigger	4-37
10. High Sweep	4-38
11. Input Verification	4-39
12. Sync Out	4-40

Chapter 4

VERIFICATION

The tests given in this chapter verify the electrical performance of a single channel of the HP 70700A Digitizer module. This is done by using the HP 70700A Digitizer Performance Test Software provided with this manual. If the module passes this verification, its operation is also assured within an HP 70000 Modular Spectrum Analyzer System.

This chapter contains the following information:

- **Required Test Equipment** lists standard and specialized test equipment needed for the performance tests.
- **Performance Test Software** describes how to install, configure, and operate the HP 70700A Digitizer Performance Test software.
- **Test Descriptions** contains a full list of the tests of specified performance and functional tests. (Tests of specified performance verify that the module meets its specifications; these tests are required for calibration and are all automated. Functional tests are used to check the functionality of the module during troubleshooting or after a repair; these tests are not required for calibration, and several are manual rather than automated.) This section also includes test descriptions, which consist of test setup instructions, a list of equipment for each specific test, and instructions for running the manual tests.

NOTE

Some systems (e.g., multiple-digitizer systems) may have more than one channel available. For information about testing each channel, refer to Testing Multiple Channels in the Operation section of this chapter.

REQUIRED TEST EQUIPMENT

STANDARD TEST EQUIPMENT

The equipment and accessories required for the performance tests are listed below in Table 4-1. Other equipment may be substituted if it meets or exceeds the requirements listed in Table 4-2 (however, the user must supply the instrument driver).

Table 4-1. Required Test Equipment and Accessories

Equipment	HP Model Number
Function Generator	HP 8116A
DC Source	HP 8116A
Level Generator	HP 3335A
Pulse Generator	HP 8116A, Opt. 001
Voltmeter	HP 3456A
Mainframe	HP 70001A
Display	HP 70205A or HP 70206A
Technical Computer	See Note, below
Graphics/Non-Graphics Printer (Optional)	Any HP-IB Printer
1 MHz and 10 MHz Low-Pass Filters	See Specialized Test Equipment, below
Accessories	
Cable, 122 cm (4 ft.) BNC (m) to SMB (m)	HP 85680-60093
Cable, 122 cm (4 ft.) BNC (m) to BNC (m)	HP 10503A

NOTE

Refer to the **Computer Compatibility** section of this chapter for the technical computer requirements.

Table 4-2. Critical Specifications for Test Equipment

Equipment	Critical Specifications
Level Generator	Frequency Range: 200 Hz to 50 MHz Stability: $\pm 1 \times 10^{-7}$ /month Resolution: 0.01 Hz Amplitude Range: +12 to -85 dBm Resolution: 0.01 dB Flatness: 200 Hz to 50 MHz, ± 0.2 dB Step Attenuator Accuracy: +12 to -26 dBm: ± 0.025 dB -26 to -46 dBm: ± 0.03 dB -46 to -85 dBm: ± 0.09 dB Harmonics <-40 dBc
1 MHz Low-Pass Filter	<1 dB Loss at 1 MHz >40 dB Stop Band at 2 MHz
10 MHz Low-Pass Filter	<1 dB Loss at 10 MHz >40 dB Stop Band at 20 MHz

SPECIALIZED TEST EQUIPMENT

Two filters are required for the HP 70700A Digitizer Performance Tests: a 1 MHz low-pass filter, and a 10 MHz low-pass filter. Schematics and parts lists are provided to allow you to build the filters. See Figures 4-1 and 4-2.

A board assembly containing pre-built filters can be purchased through your nearest Hewlett-Packard Sales Office. This assembly also includes a 5 MHz low-pass filter that is not used in the HP 70700A Digitizer Performance Tests, in addition to the 1 MHz and 10 MHz low-pass filters. Refer to the Replaceable System Parts section of Chapter 5 for information on the filter board assembly part number.

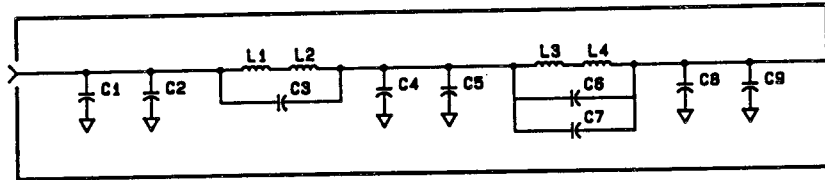

Reference Designator	HP Part Number	CD	Description
C1	0160-2225	5	2000 pF
C2	0160-2226	6	2200 pF
C3	0140-0199	6	240 pF
C4	0140-0170	3	5600 pF
C5	0160-2218	6	1000 pF
C6	0160-2213	1	620 pF
C7	0140-0190	7	39 pF
C8	0160-2225	5	2000 pF
C9	0160-2225	5	2000 pF
L1	9140-0111	1	3.3 uH
L2	9100-1610	3	150 nH
L3	9140-0111	1	3.3 uH
L4	9140-0309	9	1.8 uH

Figure 4-1. 1 MHz Low-Pass Filter, Schematic with Parts Identification

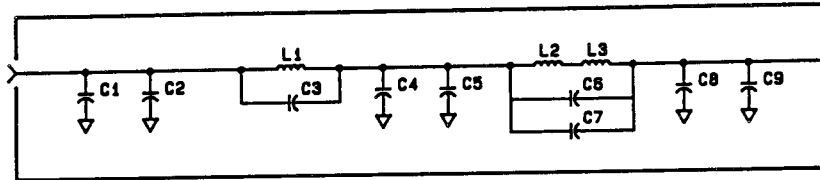

Reference Designator	HP Part Number	CD	Description
C1	0160-0939	4	430 pF
C2	0140-0201	1	12 pF
C3	0140-0145	2	22 pF
C4	0160-2213	1	620 pF
C5	0140-0190	7	39 pF
C6	0140-0214	6	60 pF
C7	0140-0209	9	5 pF
C8	0140-0200	0	390 pF
C9	0140-0202	2	15 pF
L1	9140-0096	1	1 uH
L2	9100-1611	4	220 nH
L3	9140-0094	9	.68 uH

Figure 4-2. 10 MHz Low-Pass Filter, Schematic with Parts Identification

PERFORMANCE TEST SOFTWARE

INTRODUCTION

This section describes how to install, configure, and operate the HP 70700A Digitizer Performance Test Software. The software provides testing for the HP 70700A Digitizer's specifications.

Before running the software, read the rest of this chapter. Then follow the instructions in the Installation/Configuration section for installing the hardware and software.

Computer Key Names

Computer key names and execution differ depending on the HP Series 200/300 Computer used. The verification instructions in this manual assume the use of an HP Series 200 keyboard. If your key names do not match those found in the text, substitute the alternate key names described below.

Keys Used in Text	Alternate Key
[EXECUTE]	[Return]
[ENTER]	[Return]
[RUN]	press [System], then [Run]
[CONTINUE]	press [System], then [Continue]

Program Versions

The program version number (e.g., Rev. A.01.00) is displayed in the upper right-hand corner of the Main Menu.

Computer Compatibility

The program can be run on the following HP Series 200/300 Computers. (1.5 megabytes of total RAM memory is required):

- HP 9816
- HP 9836
- HP 9920 (with an HP 35721A Monitor)
- HP Series 300 Computer (Refer to Note, below)

NOTE

HP Series 300 Computers should have a standard monitor. This program will not work with a high-resolution monitor.

Computer Language Compatibility

The software runs on HP BASIC 3.0 or later that has the following BIN files loaded:

CLOCK	GRAPH	KBD
CS80	GRAPHX	MAT
DISC	HPIB	MS
ERR	IO	PDEV

If the software will be operating in a shared resource environment, the following BIN files are also required:

DCOM
SRM

Printer Compatibility (Graphics/Non-Graphics)

The program will support any HP-IB printer. However, many of the printed test results require a graphics printer. If a non-graphics printer is used, graphical test results will not be sent to the printer.

OPERATION

This section gives an overview of the menu structure for the Performance Test Software. An explanation of how the measurement uncertainty for the program is calculated is also included in this section.

Menu Structure

The first menu displayed by the program is the Main Menu. All other menus are accessed from Main Menu softkeys. The menus are:

First level
MAIN MENU

Second level
MASS STORAGE MENU
PARAMETER MENU
EQUIPMENT MENU
HP-MSIB MAP SCREEN MENU
TEST MENU

The Mass Storage, Parameter, Equipment, and HP-MSIB Map Screen menus are configuration menus that initialize the software for operation. The Test Menu allows the selection and execution of the desired tests. Detailed information on each menu is provided following the Installation/Configuration section of this chapter.

NOTE

There are minor differences between the appearance of the menus on the HP 9816/9836 Computers and the HP Series 300 Computers due to the different keyboards.

Main Menu

The Main Menu accesses all other program menus. It is the first menu displayed upon installing the software. A verification of HP 70700A Digitizer operation may be initiated from the Main Menu. Figure 4-3 illustrates the Main Menu's structure and softkeys.

Configuration Menus

Figure 4-4 illustrates the structure and softkeys used for each configuration menu.

Mass Storage Menu: customizes the mass storage environment, if used.

Parameter Menu: controls operating conditions of the program, such as destination of test results and printer lines per page.

Equipment Menu: enters the model numbers and HP-IB address of the external test equipment (ETE) and the device under test. The program needs this information to locate the equipment on the HP-IB successfully.

HP-MSIB Map Screen Menu: indicates the system being tested. This menu is also used to select the channel to be tested, if there is more than one channel available in the system.

Test Menu

The Test Menu allows the user to select and run the tests. Figure 4-5 illustrates the Test Menu's structure and softkeys. For a complete list and description of the performance tests, see the Test Descriptions section of this chapter.

Command/Edit Screens

Two kinds of screens are displayed in the menus: **edit** and **command** screens. An edit screen allows the user to edit or input text on the display. Command screens allow the user to choose menu functions. These functions include storing information changed with the edit screen, test mode selection, access to "Help" displays, and exiting to the Main Menu.

The Main, Test, and HP-MSIB Map Screen menus use command screens only. The Mass Storage, Parameter, and Equipment menus use both edit and command screens. The edit screen always appears first. The command screen is then accessed through the *DONE* softkey.

Menu Cursor: The menu cursor is used to indicate screen selections. To move the cursor, rotate the knob or press the cursor keys on the computer keyboard.

Common Menu Softkeys: The following three softkeys are common to all command screens:

Main Menu returns program operation to the Main Menu.

Help displays a description of the menu and its softkeys.

Quit allows the user to leave the Performance Test program.

Limited Cal

Limited Cal, a subset of the performance tests, is used to verify the operation of the system. Use Limited Cal whenever system operation needs to be verified, or after any repair. The remaining performance tests are used for troubleshooting or for a full calibration. Limited Cal may be run from either the Main or Test menus.

Printing Test Results

The Performance Test program uses printed test results for permanent test records. The Parameter Menu configures the program to print test results, and also controls their format. If the Parameter Menu is configured to have test results printed, they are automatically printed during testing if an HP-IB printer is on the interface bus.

Output Format: The printed test results contain a title page and a summary page.

The title page lists the following information:

- Test date
- Serial number of the tested instrument
- Firmware versions of the tested instrument
- Test person identification (from Parameter Menu)
- Power line frequency (from Parameter Menu)
- Model numbers of test equipment with ID, or blanks for identification

The summary page lists the following information:

- Tests that passed (Passed)
- Tests that failed (Adjust)
- Tests not run because of unavailable external test equipment (Missing ETE)
- Tests that were aborted (Aborted)

Test Results

For each test, the program indicates whether the instrument passed the test limits. The measurement uncertainty for each test is calculated based on the test equipment. See the Required Test Equipment section in the beginning of this chapter.

VERIFICATION

Testing Multiple Channels

When there is more than one channel available in a digitizer system, the HP-MSIB Map Screen Menu contains a softkey, *Channel*, to allow selection of the channel to be tested.

The software will only test one channel of a system at a time. After one channel has been tested, use *Channel* in the HP-MSIB Map Screen Menu to select the next channel to be tested.

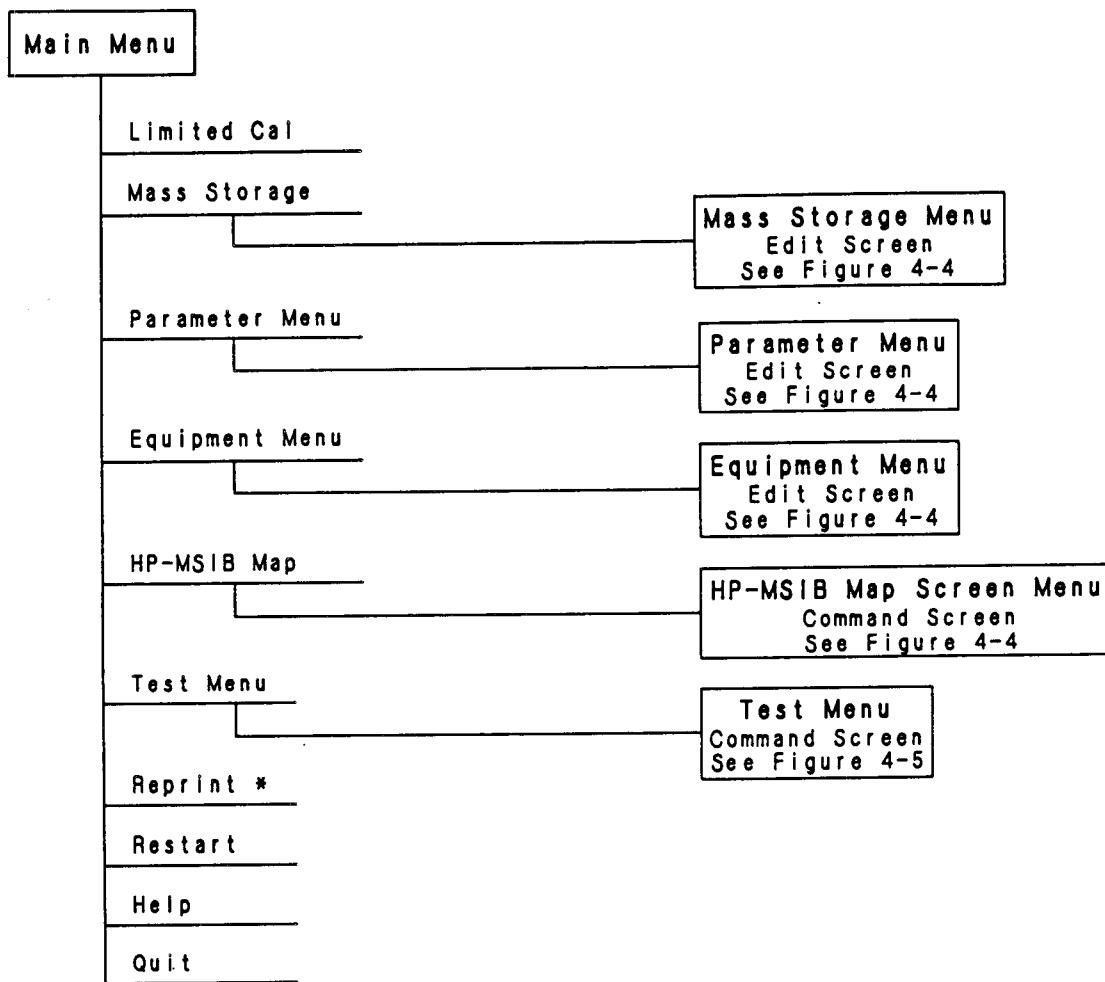

* This softkey is only shown if a printer is available.

Figure 4-3. Main Menu Softkeys

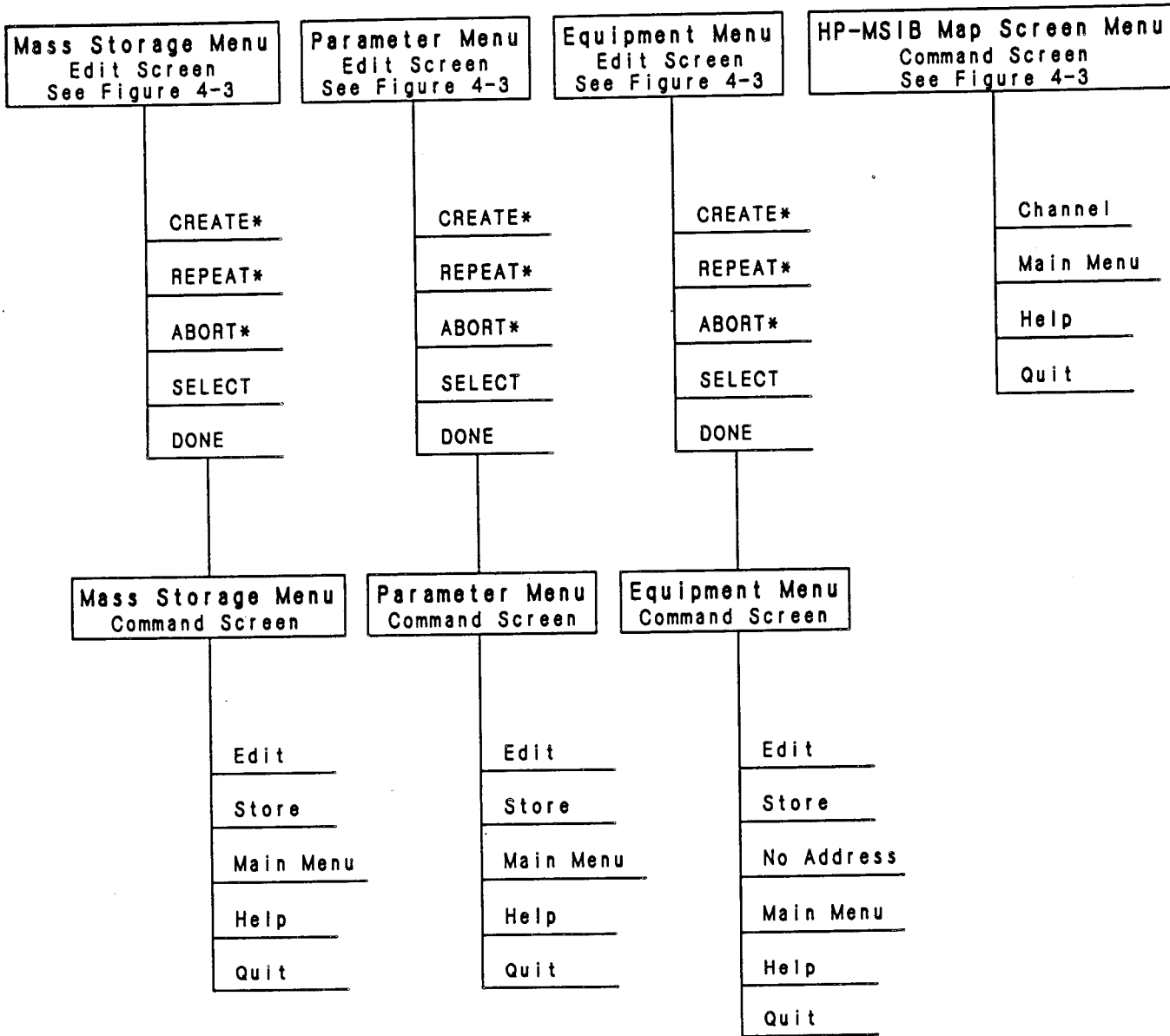

* Softkey that is displayed when the menu is entered for the first time.

Figure 4-4. Configuration Menus Softkeys

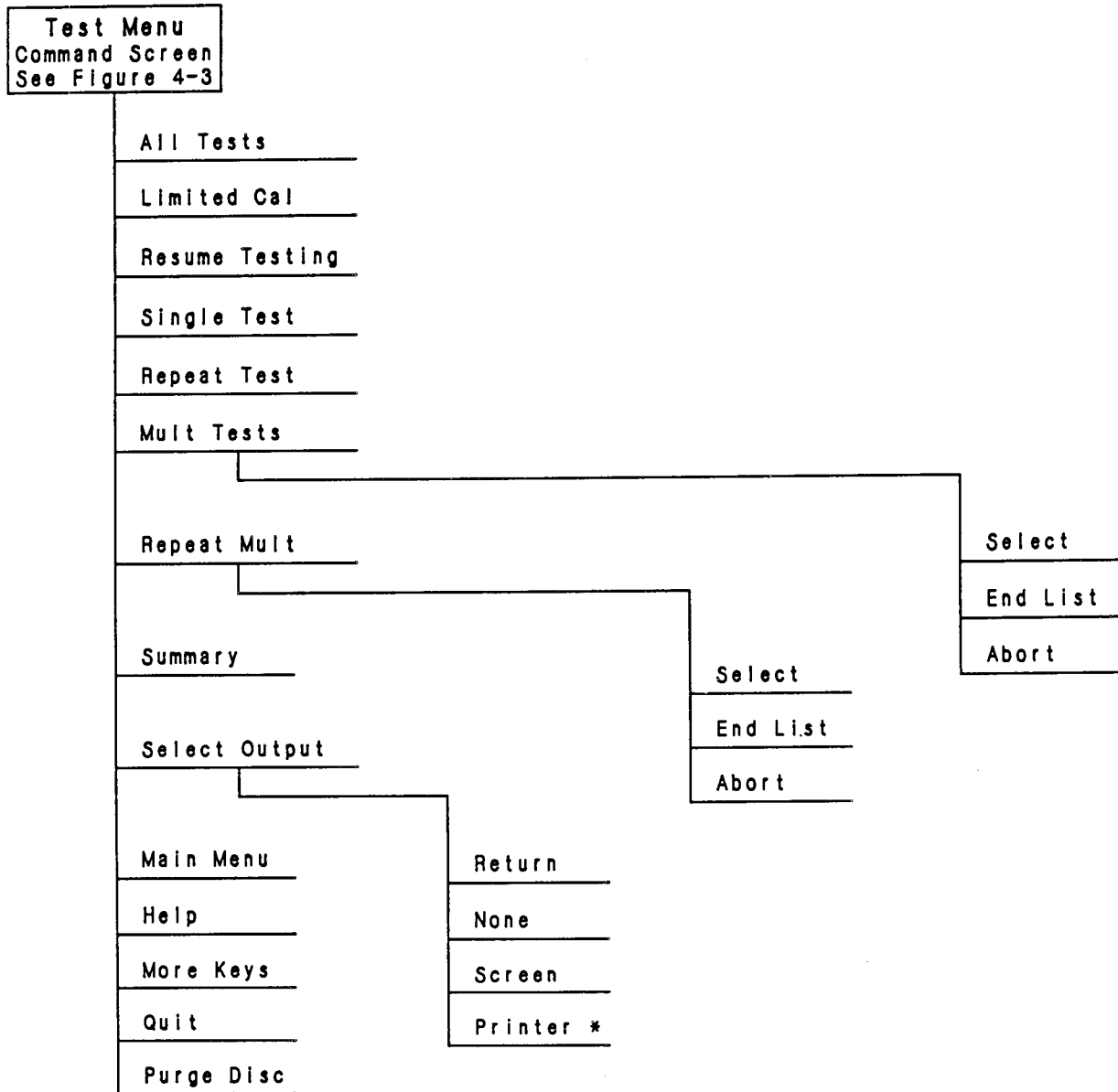

* Softkey is only shown if there is a printer available.

Figure 4-5. Test Menu Softkeys

MEASUREMENT UNCERTAINTY

The Performance Test program combines individual uncertainties involved in each measurement to calculate total uncertainty. This total uncertainty is then multiplied by a coefficient, and this result is combined with the specifications to set test limits. These limits are used to determine whether the system under test has acceptable performance. Hewlett-Packard uses a coefficient of zero; therefore, the test limits are set at the limits of the specification range. See Figure 4-6.

The total uncertainty determines which measured values are definite and which are ambiguous. See Figure 4-6. These values are listed in tabular format with test results that are sent to the computer screen or a printer. The Parameter Menu is used to set the destination and format of the test results.

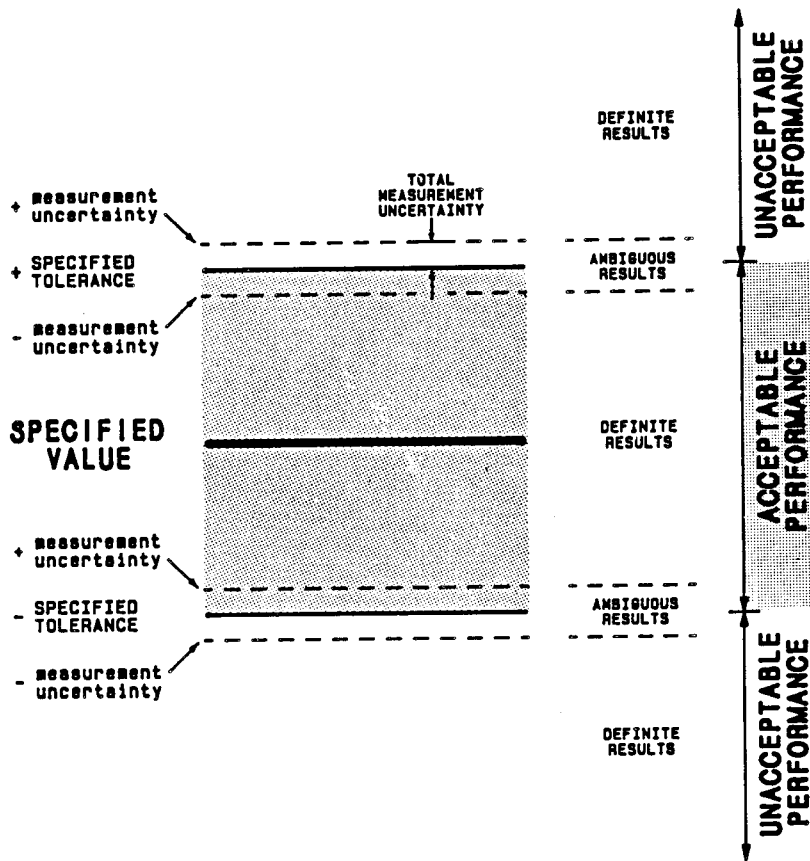

Figure 4-6. Acceptable Measurement Range

Combining Individual Uncertainties

Individual uncertainties of each measurement are dependent on models of test equipment and measurement technique that the program uses. These uncertainties can be combined to obtain a total measurement uncertainty in two ways: worst case, and root-sum-of-the-squares

Worst Case analysis determines the largest possible value of total measurement uncertainty. This is generated by summing the absolute magnitudes of individual measurement uncertainties as follows:

$$|U_1| + |U_2| + |U_3| + \dots + |U_n|$$

Root-Sum-of-the-Squares (RSS) uncertainty is based on the fact that individual uncertainties are independent of each other. They can, therefore, be combined as random variables as follows:

$$\sqrt{\left(\frac{U_1}{M_1}\right)^2 + \left(\frac{U_2}{M_2}\right)^2 + \left(\frac{U_3}{M_3}\right)^2 + \dots + \left(\frac{U_n}{M_n}\right)^2}$$

where

U_i = uncertainties in the particular measurement (linear)
 M_i = expected value of the measurement (in linear)

The RSS is an accurate and statistically significant estimate of the total measurement uncertainty. The Worst Case Sum simply defines the boundaries of the total uncertainty without giving a specific estimate of it. The performance tests use RSS where appropriate.

Combining Uncertainty and Specification

The way that total measurement uncertainty is combined with the specification is separately controlled for each test. Each test has a measurement uncertainty coefficient that is multiplied by the total measurement uncertainty. This result is then combined with the specification to determine whether it is within specification. The Performance Test program shipped with a modular system has this coefficient set to zero. Figure 4-6 illustrates acceptable performance when the coefficient is set to zero.

The uncertainty coefficient can be changed by modifying the TEST_LIST files. (Since these are ASCII files, the GET and SAVE commands must be used to retrieve and store them.) There is one TEST_LIST file on each Test Disc and on the Operating Disc. This file has a section for each test on that disc. Each section has a line labeled FLAGS. The number after the second comma on a line is the measurement uncertainty coefficient for that test. A negative coefficient tightens the test limit. For example, a coefficient of -1 tightens the test limit by the uncertainty times 1.

NOTE

When the Performance Test program is used to verify warranted performance, the uncertainty coefficient must be zero for all tests. Figure 4-6 illustrates what is acceptable performance (i.e., within specification) when the coefficient is zero.

INSTALLATION/CONFIGURATION

The software must be installed and configured before testing can begin. The installation and configuration procedure given below consists of the following stages:

- Connecting the hardware
- Installing the BASIC language system
- Loading Performance Test Software
- Configuring the software
- Loading the test discs

NOTE

Do not use RAM memory volume ":MEMORY, 0, 15". This is used by the program.

Connecting the Hardware

1. Connect the HP 70000 Modular Measurement System to the computer. The computer port used for the connection depends upon the following criteria:
 - a. If the computer has an HP 98624A HP-IB Interface, connect the HP 70000 Modular Measurement System HP-IB to the computer port labeled HP-IB SELECT CODE 8. The HP 98624A must be switched to an HP-IB controller device.
 - b. If the computer does not have an HP 98624A HP-IB Interface, connect the HP 70000 Modular Measurement System HP-IB to the computer port labeled HP-IB SELECT CODE 7.
2. Connect HP-IB cables from the external test equipment to the computer port labeled HP-IB SELECT CODE 7.
3. Connect the HP-IB of the external dual disc drive, if one is used, to the computer HP-IB port labeled HP-IB SELECT CODE 7. Use a 0.5 metre HP-IB cable, such as HP 10833D.
4. Turn on the external test equipment and HP 70000 Modular Measurement System, and allow them to warm up as specified in each respective manual.
5. Turn both the computer and external disc drive on.

Installing the BASIC Language System

6. Refer to the computer manual for instructions on how to load HP BASIC. Due to the variety of computer system configurations possible, it is not appropriate to include detailed language system installation procedures in this manual.

Loading Performance Test Software

7. Insert the disc labeled "Executive Disc #1" into the default drive of the computer. For external disc drives this will be the left-hand drive.
8. Type LOAD "700_PT", 1. Press [EXECUTE].
9. After a short time, the computer will beep and instruct you to replace Executive Disc #1 (in the default drive) with Executive Disc #2. After replacing the disc, press [CONTINUE]. When prompted, supply date and time information and press [ENTER].

Configuring the Software: Mass Storage Menu

10. The computer should display the following message with softkeys:

No Mass Storage Parameters were found. Either press Continue to use defaults, or press EDIT MS to change OPERATING volume.

11. If you are using the default disc drives, press *CONTINUE*, and continue this procedure with step 15. If you are **not** using the default disc drives, you need to edit the "MSUS" for the "Operating" Volume Label in the Mass Storage Menu. (Refer to the Mass Storage Menu section of this chapter for more information.) Continue with step 12.

NOTE

Although changes can be made to the Mass Storage Menu configuration at this point, any changes made cannot be stored until the Operating disc has been inserted.

12. Press *EDIT MS*. The Mass Storage Menu will be displayed.
13. Refer to the Mass Storage Menu section in this chapter. Read the explanation of the Mass Storage Menu.
14. Perform steps 1 through 7 of the Menu Editing procedure in the Mass Storage Menu section. After completing the procedure, continue with step 15 below.
15. After a short time, the computer will beep and instruct you to replace Executive Disc #2 (in the default drive) with the OPERATING disc. Press [CONTINUE].
16. The Main Menu should be displayed on the computer. At this time, if anything except an HP 9836 is being used, the Mass Storage Menu configuration should be verified. Any changes made to the Mass Storage Menu configuration can now be stored using the Menu Editing procedure in the Mass Storage Menu section.

Configuring the Software: Parameter Menu

17. Press *Parameter Menu*. The Parameter Menu will be displayed.

18. Refer to the Parameter Menu section in this chapter for instructions on setting the value of the program operating parameters. When all the desired parameter values have been entered, and the data is stored, press **Main Menu**.
19. The Main Menu should be displayed on the computer.

Configuring the Software: Equipment Menu

20. Press **Equipment Menu**. The Equipment Menu will be displayed.
21. Refer to the Equipment Menu section in this chapter for instructions on entering information about the external test equipment. When all data entry is complete, and the data is stored, press **Main Menu**.
22. The Main Menu should be displayed on the computer.

Configuring the Software: HP-MSIB Map Screen Menu

23. Press **HP-MSIB Map**. The computer will search for the HP 70700A Digitizer system listed in the Equipment Menu. When found, the HP-MSIB Map Screen Menu will be displayed. If your system has more than one channel, use the **Channel** softkey to select the channel to be tested.
24. Press **Main Menu**.

Loading the Test Discs

NOTE

Step 25 below assumes the use of the default disc drive. If the Mass Storage Menu has been configured to use memory disc drives other than the default drives, make sure that Test Disc # 1 is placed in the appropriate drive.

25. Place Test Disc #1 into the empty drive.
26. Press **TEST MENU**. The computer will load the test disc and then display the Test Menu. Although the Test Menu contains the directory of all available tests, some of the actual tests may be located on the remaining test discs. If a test is selected that is contained on one of these other discs, the display will produce an error message for a missing disc. Take out Test Disc #1, replace it with the Test Disc called out in the error message, and press **REPEAT**.
27. The software is now ready to begin testing. Refer to the Test Menu section of this chapter for instructions on using the Test Menu.
28. Refer to the Test Descriptions section in this chapter for important information about the test setups used for each test, and test equipment preparation.

MAIN MENU

The Main Menu is the first menu displayed by Performance Test Software. It provides access to all other program menus. The Main Menu does not have an edit screen.

Menu Softkeys

Limited Cal places the program in the Limited Cal mode of the Test Menu. If all of the external test equipment is available for performing the tests, then this mode will execute all Limited Cal tests that are listed in the Test Menu.

NOTE

If the Equipment Menu has not been properly configured, the program cannot perform a complete Limited Cal. Instead, it will run only the Limited Cal tests for which the equipment is configured.

Mass Storage displays the Mass Storage Menu, which allows control of the mass storage conditions of the program.

Parameter Menu displays the Parameter Menu, which allows control of the operating conditions of the program.

Equipment Menu displays the Equipment Menu, which enables entry of model numbers and HP-IB addresses of external test equipment.

HP-MSIB Map displays the Map Screen Menu, which shows the systems presently on the HP-MSIB and their HP-MSIB addresses. When a system has more than one channel, this menu allows the user to select the channel to be tested.

Test Menu displays the Test Menu. When this softkey is pressed, the program searches the HP-IB for an instrument at each address specified in the Equipment Menu. If an invalid address is found, the program defaults to the Equipment Menu and places parentheses around the corresponding instrument.

Reprint provides a printout of test data collected if Save For Reprinting: Yes was selected in the Parameter Menu.

Help displays a description of the Main Menu and its softkeys. The following softkey is also presented:

Return Press this softkey to return to the command screen.

Quit displays the Quit Screen. The screen asks if the program is to be terminated and presents two softkeys:

Yes stops the program, leaving the computer in HP BASIC.

No displays the command screen.

Restart provides a means to restart the program. Note that pressing this softkey sets the program to purge stored test data from the disc, and removes test status in the Test Menu, when the Test Menu is next entered.

MASS STORAGE MENU

The Mass Storage Menu allows the operator to customize disc configuration. This configuration information tells the computer where to find the major sections of the program. These sections are called Volumes. For example, the menu may be configured for storing the Volumes in a Shared Resource Management (SRM) environment.

The Volume labels used by the software are:

DATA: a temporary storage area for individual test equipment parameters and limits

ERROR LOG: contains logging errors.

OPERATING: contains all program data storage.

TEST DISCS: contain(s) system tests. The number of test discs varies depending upon the specific software sent with your manual and the revision of that software.

The location of each Volume is set to default values until changed by the operator. The DATA, ERROR LOG, and OPERATING Volumes are accessed often and should be readily available. They may have the same MSUS (Mass Storage Unit Specifier), and be stored on the same disc.

Although the Volume labels cannot be edited, their MSUS and Directory Path data fields may be changed. For the proper command to use when editing the MSUS field, refer to the Language Reference for the language (e.g., BASIC 4.0 or 5.0) being used. The Directory Path should only be used if an SRM system is used, or you are using BASIC 5.0 or later. Otherwise, leave this field blank.

Menu Editing

1. Move the cursor to the desired Volume label. Then, move the cursor to the MSUS field. The Directory Path field is used only in an SRM environment.
2. Press **SELECT** and type in the new location.
3. Press **[ENTER]** to terminate data entry.
4. Repeat steps 1 through 3 for each Volume label.
5. Press **DONE** when all editing is finished. This will exit you to the command screen.
6. Press **Store Items** to save the edited information.
7. Press **Main Menu** to return to the Main Menu.

Edit Screen Softkeys

SELECT activates the field indicated by the cursor for data entry.

DONE displays the command screen.

Command Screen Softkeys

Edit Items displays the Mass Storage edit screen.

Store Items stores mass storage parameters on disc for future use.

Main Menu returns the program to the Main Menu.

Help displays a description of the Main Menu and its softkeys. The following softkey is also presented:

Return Press this softkey to return to the command screen.

Quit displays the Quit Screen. The screen asks if the program is to be terminated and presents two softkeys:

Yes stops the program, leaving the computer in HP BASIC.

No displays the edit screen.

PARAMETER MENU

The Parameter Menu allows the user to set, or change, the value of program operating parameters.

Operating Parameters (Edit Screen)

Results sent to: flags program to send test result data to the screen or the HP-IB printer.

Valid Entries: Screen
 Printer
 None

Output Format: determines if the test result data will be presented in graph or table form. Enter **Graph** and the data will be in tabular or graph form, depending on the test. A graphics printer is required if the output is sent to a printer. Enter **Table** for results that are several pages long.

Valid Entries: Graph
 Short Table
 Table

Save For Reprinting: determines whether the test result data will be saved on disc for reprinting. The stored test results may be reprinted with the **Reprint** softkey in the Main Menu.

VERIFICATION

The stored test results can be purged with the *Purge Disc* softkey in the Test Menu. Test results are automatically purged when the Test Menu is first re-entered after running the program. The program assumes that the existing test results are from a previous instrument, so it purges the disc record to accommodate new test results.

Valid Entries: Yes
 No

Printer Lines: sets the number of lines the HP-IB printer can print per page. The program uses this number to make logical page breaks when printing test results.

Valid Entries: 50 to 70

Line Frequency: enter the power line frequency. The program prints the selected answer with those test results that can be affected by the power line frequency.

Valid Entries: 50
 60
 400

Ambient Temperature: is used to determine if the test limits should reflect temperature-drift guard-bands. Enter the ambient temperature in Celsius.

Valid Entries: 0 to 55

Equipment Calibration Period: Enter the number of months that have passed since the external test equipment was calibrated. The program uses this number in some of the measurement uncertainty calculations. It prints the number on the header page of the output report.

Test person's ID.: enter the name or ID number of the person running the program. This information is printed on the output report.

Number lines added: this parameter allows a message to be printed with the test results. Use the following steps to enter a message:

1. Place the cursor to the left of the first "User Line" on the screen and type in the desired message. Each line provides for the entry of up to 20 characters. Use additional lines for messages longer than 20 characters.
2. Place the cursor at "Number lines added" on the display and enter the number of "User Lines" used. Up to thirty lines can be created.

Menu Editing

1. Move the cursor to the Operating Parameter that you want to edit.
2. Press *SELECT* to activate the "User Supplied" field for editing.

3. Type in the new parameter value.
4. Press [ENTER] to terminate data entry.
5. Repeat steps 1 through 4 to change any parameter.
6. Press DONE when all editing is finished. This will exit you to the command screen.
7. Press Store to save the parameter values. If the data is being saved for the first time, the computer will beep and an error message will prompt you to create a file. Press CREATE.
8. Press Main Menu to return to the Main Menu.

Edit Screen Softkeys

SELECT activates the field indicated by the cursor for data entry.

DONE displays the command screen.

Command Screen Softkeys

Edit displays the edit screen.

Store Params stores the parameter on disc for future use.

Main Menu returns program to the Main Menu.

Help displays a description of the Parameter Menu and its softkeys. The following softkey is also presented:

Return Press this softkey to return to the command screen.

Quit displays the Quit Screen. The screen asks if the program is to be terminated and presents two softkeys:

Yes stops the program, leaving the computer in HP BASIC.

No displays the edit screen.

EQUIPMENT MENU

The Equipment Menu allows the user to enter the model numbers, HP-IB addresses, and serial numbers of external test equipment (ETE). This information is necessary for program operation. If this information is missing, the program may indicate "Missing ETE" next to several tests in the Test Menu. For a list of equipment types required for a specific test, refer to the Test Descriptions section of this chapter.

Using the preferred models ensures the most complete testing capability. Using acceptable models may affect measurement uncertainty.

Edit/Command Screens: Use the edit screen to enter device model numbers, addresses, serial numbers, and availability of equipment. Use the command screen to enter calibration data for the power sensor. The power sensor serial number must be entered in the edit screen. All other serial number entries are optional; their only application is that they are printed on the test results.

NOTE

When the Equipment Menu is exited, or the Test Menu is entered, the program searches the HP-IB for an instrument at each address specified in the Equipment Menu. If an address fails to respond, the program defaults to the Equipment Menu's command screen. Press Edit to display the edit screen, and move the cursor to view the ADDRESS column. Each invalid address will be in parentheses. See the description of No Address in this section.

Device Data Entry

The edit screen is divided into four columns: DEVICE TYPE, DEVICE MODEL, ADDRESS, and SERIAL NUMBER. The DEVICE TYPE cannot be edited. Use the following steps to view the DEVICE TYPE, or edit the other selections:

1. Move the cursor to DEVICE TYPE to see which device types are needed for the tests. See the equipment list for test equipment models supported for this software.
2. Move the cursor to the DEVICE MODEL to be edited and press SELECT to activate the field for data entry.
3. Type in the model number of the equipment selected and press [ENTER].
4. Move the cursor to ADDRESS and press SELECT to activate the field for data entry.

NOTE

The address is a three-digit number consisting of the HP-IB SELECT CODE and HP-IB address of the instrument. For example, if an HP 70000 Modular Measurement System has an HP-IB SELECT CODE of 8, and an HP-IB address of 21, the address that would be entered for the system is 821.

5. Type in the address for the equipment selected. The valid address ranges for an HP 70000 Modular Measurement Series master module are 700 to 730 and 800 to 830. The valid address range for any other equipment is 700 to 730. Any device type with "N/A" indicates that the address is not applicable. Editing "N/A" has no affect.
6. Press [ENTER] to terminate the data entry.

NOTE

If a passive device (e.g., filter) is not available, do not enter a serial number for it. Leave its serial number field blank.

7. Move the cursor to the SERIAL NUMBER column, press SELECT, and type in the number. A serial number is a five-digit identifier of any equipment. Serial numbers must be five digits or less.
8. Press [ENTER] to terminate data entry.
9. Repeat steps 1 through 8 for all the required device types.
10. Press DONE to display the command screen. Press Store to save the equipment data just entered. If the data is being saved for the first time, an error message will be displayed, prompting you to create a file. Press Create.
11. Press Main Menu to return to the Main Menu.

Edit Screen Softkeys

SELECT activates the field indicated by the cursor for data entry.

DONE displays the command screen.

Command Screen Softkeys

Edit Items displays the edit screen.

Store Equip stores the equipment list on disc for future use.

No Address This softkey is presented only when the program cannot find an instrument at a specified HP-IB address and defaults to this menu. Pressing this softkey automatically deletes these addresses from the edit screen.

Main Menu returns the program to the Main Menu.

Help displays a description of the Main Menu and its softkeys. The following softkey is also presented:

Return Press this softkey to return to the command screen.

Quit displays the Quit Screen. The screen asks if the program is to be terminated and presents two softkeys:

Yes stops the program, leaving the computer in HP BASIC.

No displays the edit screen.

HP-MSIB MAP SCREEN MENU

The HP-MSIB Map Screen Menu lists the modules and corresponding HP-MSIB addresses of the HP 70000 Modular Measurement System under test. The HP-MSIB address of the master module is also the system address. Refer to the Equipment Menu section of this chapter for instructions on configuring the software for the system under test.

When the system under test has more than one channel available, the Channel softkey allows selection of the channel to be tested. Refer to Testing Multiple Channels under Operation in this section for more information.

Command Screen Softkeys

Channel allows selection of the channel that will be tested.

Main Menu returns the program to the Main Menu.

Help displays a description of the Main Menu and its softkeys. The following softkey is also presented:

Return Press this softkey to return to the command screen.

Quit displays the Quit Screen. The screen asks if the program is to be terminated and presents the following two softkeys:

Yes stops the program, leaving the computer in HP BASIC.

No displays the command screen.

TEST MENU

The Test Menu allows selection of the different types of testing available. It also provides a list of all performance tests.

If the external test equipment required to do one of the tests is not present on the HP-IB, the message Missing ETE appears onscreen next to the test. The program will not run a test with missing test equipment.

Once testing begins, the program prompts the operator to make any necessary interconnections between the external test equipment and the system under test. Error messages produced by the program are described in the Error Messages section of this chapter.

NOTE

If the Equipment Menu is selected anytime after the testing begins, the status (Pass/Fail/Abort) information is lost.

Command Screen Softkeys

ALL Tests All tests listed in this menu will be run sequentially.

The following softkeys are presented during testing:

End Sequence The program completes the test in progress and then returns program operation to the Test Selection Menu.

Abort Tests The program interrupts the test in progress and then returns program operation to the Test Selection Menu.

Limited Cal Limited Cal tests listed in this menu will be run sequentially.

The following softkeys are presented during testing:

End Sequence The program completes the test in progress and then returns program operation to the Test Selection Menu.

Abort Tests The program interrupts the test in progress and then returns program operation to the Test Selection Menu.

Resume Testing This softkey appears only when Limited Cal or All Tests has been interrupted by the pressing of the **End Sequence** or **Abort Tests** softkeys. Pressing **Resume Testing** causes the program to continue testing.

Single Test The program runs the test indicated by the cursor.

The following softkey is presented during testing:

Abort Test The program interrupts the test in progress and then returns program operation to the Test Selection Menu.

Repeat Test The program runs the test indicated by the cursor repeatedly until interrupted. This mode indicates, next to the listing of the test being run, how many times the test passed versus how many times it was run (e.g., P=3/5).

The following softkeys are presented during testing:

End Sequence The program completes the test in progress and then returns program operation to the Test Selection Menu.

Abort Test The program interrupts the test in progress and then returns program operation to the Test Selection Menu.

Mult. Tests The program allows the user to define a set of tests to be performed in sequence by the program.

The following softkeys are presented for determining tests:

Select Select a test with the cursor and then use this softkey to assign a number to the test. Numbering starts with one. Tests will be run in the order in which they are numbered.

End List Pressing this key terminates test entry and begins testing.

Abort When pressed, the Test Selection Menu is displayed.

The following softkeys are presented during testing:

End Sequence The program completes the test in progress and then returns program operation to the Test Selection Menu.

Abort Tests The program interrupts the test in progress and then returns program operation to the Test Selection Menu.

Repeat Mult The program allows the user to define a set of tests to be performed in sequence by the program. These tests will be run repeatedly until interrupted.

The following softkeys are presented for determining tests:

Select Select a test with the cursor and then use this softkey to assign a number to the test. Numbering starts with one. Tests will be run in the order in which they are numbered.

End List Pressing this softkey terminates test entry and begins testing.

Abort When this softkey is pressed, the Test Menu is displayed.

The following softkeys are presented during testing:

End Sequence The program completes the test in progress and then returns program operation to the Test Menu.

Abort Tests The program interrupts the test in progress and then returns program operation to the Test Menu.

Summary provides the operator with a printed copy of the current test results.

Select Output The program allows the user to select the output device.

The following softkeys are presented:

Screen Selects the computer screen as the output device for the test results. This softkey is displayed whenever the screen is not the selected destination for test results. Test-result data is formatted according to the "Type of format for test results?" parameter of the Parameter Menu.

Printer Selects the HP-IB printer as the output device for the test results. The softkey is displayed whenever an HP-IB printer is available but not selected as the output device. Test results data is formatted according to the "Type of format for test results?" parameter of the Parameter Menu.

More Keys If a Series 200 Computer is being use, **More Keys** is shown when there is not room for all of the softkeys to be displayed at one time. Pressing **More Keys** displays the remaining Test Menu softkeys. If a Series 300 Computer is being used, the [Next] and [Prev] keys are used to view all of the available softkeys.

Purge Disc purges the current data storage file of all previous test data.

Main Menu returns the program to the Main Menu.

Help displays a description of the Main Menu and its softkeys. The following softkey is also presented:

Return Press this key to return to the command screen.

Quit displays the Quit Screen. The screen asks if the program is to be terminated and presents the following two softkeys:

Yes stops the program, leaving the computer in HP BASIC.

No displays the command screen.

ERROR MESSAGES

Listed below in alphabetical order are the error messages produced by the Performance Test Software. These messages indicate operator errors and test status or results.

The DUT must have an HP-IB address is displayed when an attempt is made to leave the Equipment Menu, but the program cannot find the HP 70000 Series system at the HP-IB address specified.

Disc not initialized. This error message indicates a blank disc has not been initialized. After correcting the condition, press [CONTINUE] to return to normal operation.

Enter serial number first. A device serial number must be specified before calibration data can be edited or used.

Equipment list is not acceptable. The equipment selected is not on the HP-IB.

ERROR: Address is HP-IB controller address The HP-IB allows only one instrument per address. The address entered, probably 7, is reserved for the controller. Use another address.

ERROR: Address matches system disc drive The HP-IB allows only one instrument per address. The address entered matches the address of the external disc drive.

ERROR: Address not in acceptable range The HP-IB address entered must be between 700 and 730 or 800 and 830.

ERROR: Duplicate HP-IB address The HP-IB allows only one instrument per address. The same address has been entered for two different instrument model numbers.

ERROR: Non-responding HP-IB address indicates controller cannot locate an instrument at an HP-IB address. Check actual instrument addresses with address values loaded in the Test Equipment Menu.

Error XXX _____ encountered This message appears if an abnormal operation of the software has been attempted. If this message appears, contact an HP Sales and Service Office.

Fail This error message indicates that the system failed the test limits.

File already exists This message appears if an attempt is made to store or save a file that already exists on the disc. This error should not occur in normal operation.

VERIFICATION

File not on disc The file accessed is not on the disc. This error should not occur unless a disc was improperly changed.

Passed This error message indicates that the system passed the test limits.

PRGM ERROR (Program Error) This error message indicates that the program has detected an error in itself. Contact an HP Sales and Service Office for assistance.

Testing _____ **dd_mmm_yyyy** indicates the date that the test (e.g., Calibrator Amplitude) was last modified.

Timed Out indicates that the program aborted the test.

Unable to locate disc or disc changed The appropriate disc is missing. After this condition has been corrected, press [CONTINUE] to return to normal operation.

TEST DESCRIPTIONS

Each test description contains the following information: the specification being tested, whether the test is performed in the Limited Cal mode, a description of the test algorithm, a list of necessary test equipment, and a description of the test equipment setup. Test descriptions list external test equipment by generic type. Refer to the Required Test Equipment section of this chapter for a listing of acceptable model numbers for each type of test equipment.

TEST LIST

Tests of Specified Performance

1. Effective Number of Bits
2. Distortion
3. Gain Accuracy
4. Offset Accuracy
5. Frequency Response
6. Input Isolation
7. Reference Clock Accuracy

Functional Tests

8. Random-Event Capture
9. External Trigger
10. High Sweep
11. Input Verification (manual test)
12. Sync Out (manual test)

1. EFFECTIVE NUMBER OF BITS

Purpose

This test verifies the specification EFFECTIVE NUMBER OF BITS. It runs in the Limited Cal mode.

Description

The HP 70700A Digitizer's clock frequency is calculated using an FFT measurement. To improve the measurement uncertainty, test frequencies are selected that are not harmonically related to the digitizer's calculated clock frequency. Reference level measurements are made without the external filter. The filter is then inserted and the signal level is adjusted back up to the reference level. A time domain measurement is then made. An idealized best-fit sine wave for the data is identified. The rms error between the actual data and the best-fit sine wave is found and the effective number of bits is calculated.

Uncertainties

The following characteristic contributes to uncertainties:

- Digitizing uncertainty

Equipment

Level Generator
1 MHz Low-Pass Filter
10 MHz Low-Pass Filter

Equipment Setup

Connect the 50 Ω output of the level generator directly to Input 1 of the Digitizer (DUT) for the reference measurement. Then connect the 50 Ω output of the level generator to the input of the low-pass filter and connect the output of the low-pass filter to Input 1 of the HP 70700A Digitizer.

2. DISTORTION

Purpose

This test verifies the specification DISTORTION. It runs in the Limited Cal mode.

Description

The HP 70700A clock frequency is calculated using an FFT measurement. To improve the measurement uncertainty, test frequencies are selected that are not harmonically related to the digitizer's calculated clock frequency. Reference level measurements are made without the external filter. The filter is then inserted and the signal level is adjusted back up to the reference level. A frequency domain measurement is then made. The distortion is measured as the difference between the largest response and the next largest response in the frequency domain measurement.

Uncertainties

The following characteristics contribute to uncertainties:

- FFT amplitude interpolation error
- Source harmonics

The RSS total of these uncertainties is calculated for each measurement.

Equipment

Level Generator
1 MHz Low-Pass Filter
10 MHz Low-Pass Filter

Equipment Setup

Connect the 50 Ω output of the level generator directly to Input 1 of the Digitizer (DUT) for the reference measurement. Then connect the 50 Ω output of the level generator to the input of the low-pass filter and connect the output of the low-pass filter to Input 1 of the HP 70700A Digitizer.

3. GAIN ACCURACY

Purpose

This test verifies the specification INPUT, Voltage Range. It runs in the Limited Cal mode.

Description

The gain accuracy can be checked by comparing the measured value to a known value. The dc source is set to a dc voltage which is 100% of the selected voltage range. (Both positive and negative voltages are checked.) This voltage is measured by the voltmeter. The HP 70700A also measures the voltage, taking the average of a 1024-point trace. The difference between these voltages is used to calculate the percent error. This process is repeated for each voltage range (20V, 6V, 2V, and 0.6V).

Uncertainties

The following characteristic contributes to uncertainties:

- Voltmeter measurement uncertainty

Equipment

DC Source
Voltmeter

Equipment Setup

Connect the dc source output to Input 1 of the HP 70700A Digitizer. Also connect Input 1 to the input of the 1 MHz low-pass filter. Then connect the output of the filter to the voltmeter's volts input. (Refer to Specialized Test Equipment in the Required Test Equipment section of this chapter for more information about the 1 MHz filter.)

4. OFFSET ACCURACY

Purpose

This test verifies the specification INPUT, Offset Voltage. It runs in the Limited Cal mode.

Description

The dc source is set to dc volts with 0 volts of offset. The voltage is measured by the voltmeter to establish a reference for measuring the offset accuracy of the HP 70700A Digitizer. The digitizer is then set to an offset voltage and a time domain measurement is made. The average of this 1024-point trace is compared to the reference voltage to calculate the percent error for the offset voltage being tested. The process is repeated at several positive and negative offset increments for each voltage range (20V, 6V, 2V, and 0.6V).

Uncertainties

The following characteristic contributes to uncertainties:

- Voltmeter measurement uncertainty

Equipment

DC Source
Voltmeter

Equipment Setup

Connect the dc source output to Input 1 of the HP 70700A Digitizer. Also connect Input 1 to the input of the 1 MHz low-pass filter. Then connect the output of the filter to the voltmeter's volts input. (Refer to Specialized Test Equipment in the Required Test Equipment section of this chapter for more information about the 1 MHz low-pass filter.)

5. FREQUENCY RESPONSE

Purpose

This test verifies the specification INPUT, Bandwidth, and checks the input impedance. It runs in the Limited Cal mode.

Description

The HP 70700A input is set to dc, at 50 Ω . The level generator frequency is set to 1 kHz. A frequency domain measurement is made to obtain a reference level. The input signal frequency is stepped from 1 kHz to 50 MHz, and the peak amplitude is measured at each frequency. The process is repeated for each voltage range (20V, 6V, 2V, and 0.6V) to verify the bandwidth.

The 1 kHz reference level, measured with the level generator, is used as a reference for low frequency testing. The level generator is replaced by the function generator and its amplitude is adjusted to the reference level. The input signal is stepped from 1 Hz to 1 kHz, and the peak amplitude is measured at each frequency. Only the 2V range is tested.

Finally, the input is changed to ac at 1 M Ω , and the 2V range is tested over the 1 Hz to 1 kHz frequency range.

When the test is run in the Limited Cal mode, only the high frequency response is measured.

Uncertainties

The following characteristics contribute to uncertainties:

- Source amplitude accuracy
- FFT amplitude interpolation error

The RSS total of these uncertainties is calculated for each measurement.

Equipment

Function Generator
Level Generator

Equipment Setup

Connect the level generator output to Input 1 of the HP 70700A Digitizer for the high (>1 kHz) frequency part of the test. Then connect the function generator output to Input 1 of the HP 70700A Digitizer for the low (<1 kHz) frequency part of the test.

6. INPUT ISOLATION

Purpose

This test verifies the specification INPUT, Isolation. It should be run after repairs to inputs, the cabling, or the A4 Converter board assembly.

Description

A 2V, 9.5 MHz signal from the level generator is sent to Input 1 of the HP 70700A Digitizer. The amplitudes at Input 1 and Input 2 are measured by the digitizer. The difference between the amplitudes is a measure of the isolation between the two channels.

Uncertainties

The following characteristic contributes to uncertainties:

- FFT amplitude interpolation error

Equipment

Level Generator

Equipment Setup

Connect the level generator output to the HP 70700A Digitizer's rear-panel Input 1.

7. REFERENCE CLOCK ACCURACY

Purpose

This test verifies the accuracy of the internal clock. It runs in the Limited Cal mode.

Description

The level generator signal is set to 5 MHz and then is input to the digitizer (DUT). A frequency domain sweep, in a 10 MHz span, is taken. The trace location of the peak signal is determined. This information is used to narrow the span to 8 kHz, and another measurement is made. The actual trace location of the signal is compared to the expected location to calculate the error in the clock frequency.

Uncertainties

The following characteristics contribute to uncertainties:

- Source frequency error
- FFT frequency interpolation error

The RSS total of these uncertainties is calculated for each measurement.

Equipment

Level Generator

Equipment Setup

Connect the output of the level generator to Input 1 of the HP 70700A Digitizer.

8. RANDOM-EVENT CAPTURE

Purpose

This test verifies the operation of the random-event capture feature.

Description

The function generator is set to "burst" three cycles of a 95 kHz sine wave every 5 ms. The HP 70700A is put in the random-event capture mode and set to trigger on either edge at a level of 0.5V. One hundred and fifty trigger events are stored, and the timing is compared to the known values. If they are all correct, the operation of the random-event capture mode is verified.

Uncertainties

None (functional check only)

Equipment

Function Generator

Equipment Setup

Connect the function generator output to the Input 1 of the HP 70700A Digitizer.

9. EXTERNAL TRIGGER

Purpose

This test verifies the operation of the External Trigger input.

Description

The pulse generator trigger output is set to output a trigger pulse to the Digitizer's External Trigger input. The program loops ten times, each time deciding whether or not to send out a trigger. Each time the program loops, the digitizer's Operation Complete status is checked to see if it corresponds to the trigger/no-trigger condition. In this way the functional operation of the external trigger input is verified.

Uncertainties

None (functional check only)

VERIFICATION

Equipment

Pulse Generator

Equipment Setup

Connect the pulse generator trigger output to the External Trigger input on the HP 70700A Digitizer.

10. HIGH SWEEP

Purpose

This test verifies the operation of the High Sweep input. It should be run after a repair to the connector or the A5 Processor board assembly.

Description

The pulse generator is set to send a 0V to 5V, 3 Hz pulse to the HI SWP port of the HP 70700A Digitizer. The pulse generator's trigger output is connected to the digitizer's External Trigger input. The digitizer is set for single sweep at one second and the pulse generator sends a trigger to the digitizer. Since data is only taken when High Sweep is high, the resulting trace length should be high for 1/3 of the sweep. The number of trace points is counted and compared to the number of points in a full trace divided by three ($\pm 10\%$).

Then the HI SWP port of the HP 70700A is connected to the voltmeter. The voltage level out of the HI SWP port is measured with the high sweep drive enabled and disabled. These two values are compared to acceptable TTL levels to determine the port's functionality.

Uncertainties

None (functional check only)

Equipment

Pulse Generator
Voltmeter

Equipment Setup

1. Connect the output of the pulse generator to the HI SWP port on the HP 70700A Digitizer. Connect the trigger out of the pulse generator to the external trigger input of the digitizer.
2. Disconnect the pulse generator output from the HI SWP port and connect the HI SWP port to the input of the voltmeter.

11. INPUT VERIFICATION

Purpose

This is a manual test to verify the functionality of the front- and rear-panel Input 1 and Input 2 ports.

Description

A 2V, 2.5 kHz signal from the pulse generator is sent to the rear-panel Input 1 of the HP 70700A Digitizer. The amplitude is measured. The signal is then input to the front-panel Input 1 and measured to see if the amplitude is within $\pm 1\%$ of the rear-panel Input 1.

The signal is then input to the rear-panel Input 2 and the amplitude is measured. The values of the front-panel Input 1 and rear-panel Input 2 measurements are compared to verify the operation of the second input.

Uncertainties

None (functional check only)

Equipment

Function Generator

Equipment Setup

Connect the output of the function generator to the HP 70700A Digitizer rear-panel Input 1.

Procedure

1. Set the function generator output to 2.5 kHz at 2V.
2. Execute an instrument preset on the HP 70700A Digitizer by pressing the green [I-P] key on the display.
3. Set the digitizer as follows:

<i>chan 1 50 Ω</i>	enabled
<i>chan 1 VOLTS/DIV</i>	250 mV
<i>timebase SEC/DIV</i>	100 μ s
<i>markers AUTO PITPEAK</i>	enabled

4. Note the "pitpeak" amplitude of the signal in the lower right-hand corner of the display screen.

5. Disconnect the function generator output from the digitizer's rear-panel Input 1 and connect it to the front-panel Input 1 port.
6. Measure the amplitude by pressing **AUTO PITPEAK** again. The difference between the front-panel and rear-panel Input 1 amplitudes should be less than 1% of full scale, 20 mV.
7. Disconnect the function generator output from the front-panel Input 1 port and connect it to the rear-panel Input 2 port. Press **chan 1** and then **INPUT 2** to select the digitizer's second input.
8. Press **markers** and **AUTO PITPEAK** to make a measurement. The difference between the front-panel Input 1 and the rear-panel Input 2 amplitudes should be less than 1% of full scale, 20 mV.

12. SYNC OUT

Purpose

This is a manual test that verifies that the Sync Out port on the HP 70700A is functional.

Description

A signal from the function generator is sent to the external trigger input of the digitizer (DUT). When this trigger is received by the digitizer, it should send out a sync pulse. The sync pulse is then input to the digitizer so it can be measured. The displayed sync pulse should be a TTL output.

Uncertainties

None (functional check only)

Equipment

Function Generator

Equipment Setup

Connect the function generator output to the HP 70700A Digitizer's External Trigger Input. Connect the digitizer's Sync Out to its rear-panel Input 1.

Procedure

1. Set the function generator to 2.5 kHz with a peak-to-peak amplitude of 4V and an offset of 2V.
2. Execute an instrument preset on the HP 70700A Digitizer by pressing the green [I-P] key on the display.

3. Set the digitizer as follows:

chan 1 DC	enabled
chan 1 TTL	enabled
trigger EXTERNAL	enabled
trigger AUTO	enabled
display TRACE LENGTH	20 points
display GRID	enabled

4. The displayed pulse should originate near the center graticule. See Figure 4-7. Verify that the "high" and "low" voltages meet the standard TTL requirements; that is, the high should be $\geq 2.4V$ and the low should be $\leq 0.4V$. (Note that this is a functional check only.)

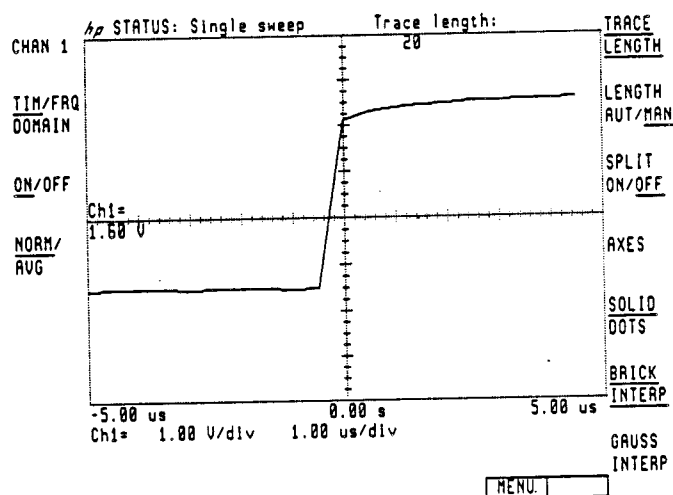

Figure 4-7. Sync Output

CONTENTS

Chapter 5. Troubleshooting	5-1
Troubleshooting Tools	5-2
Modular Measurement System Terms	5-2
Status Indicators	5-3
Error Message Reporting	5-4
HP 70700A Digitizer Self-Test	5-6
Display Tests	5-8
Confidence Test Softkey	5-10
Performance Tests	5-11
HP-MSIB Troubleshooting Utility	5-11
Diagnostic Procedures	5-12
Categorizing Failures	5-12
Troubleshooting from the Front Panel	5-13
Troubleshooting over HP-IB	5-14
Troubleshooting Catastrophic Failures	5-14
Using the HP-MSIB Troubleshooting Utility	5-18
Error Codes	5-24
HP 70700A Digitizer Error Codes	5-24
Display Error Codes	5-32
Replaceable System Parts	5-36
Ordering Information	5-36
Direct Mail-Order System	5-37
Replaceable Parts Tables	5-37

Chapter 5

TROUBLESHOOTING

This chapter contains information needed to troubleshoot an HP 70700A Digitizer system to the faulty element or mainframe. It contains the following sections:

- **Troubleshooting Tools** explains the tools (e.g., status indicators) used to isolate problems.
- **Diagnostic Procedures** tells you how to use the troubleshooting tools to identify which part of the system is faulty.
- **Error Codes** lists all of the error code messages used in the HP 70700A Digitizer system.
- **Replaceable System Parts** contains ordering information and part numbers for system-level replacement parts, cables, and service accessories.

NOTE

When troubleshooting another type of system, refer to the **Installation and Verification Manual** for the master of the system. For example, when troubleshooting an HP 71100A Spectrum Analyzer System, refer to the HP 70900A Local Oscillator Installation and Verification Manual.

TROUBLESHOOTING TOOLS

This section contains definitions of some HP 70000 Modular Measurement System terms, and explanations of the troubleshooting tools used for isolating problems in HP 70700A Digitizer systems:

- Status Indicators
- Error Message Reporting
- HP 70700A Digitizer Self-Test
- Display Tests
- Performance Test Software
- HP-MSIB Troubleshooting Utility

The information in this section should be read before using the procedures given in the Diagnostic Procedures section of this chapter.

MODULAR MEASUREMENT SYSTEM TERMS

Functional Terms refer to the types of function, or work, that a given device may perform in a system, and to the interrelationships (e.g., master or slave) that occur among the devices in a system.

Element: Any device (e.g., HP 70902A IF Section) that communicates over the HP-MSIB. In contrast, the HP 70001A Mainframe controls all HP-MSIB communication, but does not communicate over the HP-MSIB and therefore is not an element.

Slave: An element that is controlled by another element.

Master: An element that controls other elements.

Independent element: An element that is neither a master nor a slave (e.g., a display).

Instrument: An independent element, or a master with slaves, that performs a function that does not require, or rely on, another piece of equipment.

Structural Terms refer to the hardware type of the device.

Mainframe: A device designed for modules to plug into. The mainframe supplies power, cooling, and HP-IB and HP-MSIB interconnections for the modules, in addition to controlling HP-MSIB communication.

Module: A plug-in designed to work in a Hewlett-Packard modular measurement system mainframe.

Stand-Alone Instrument: An element that can function without being plugged into a mainframe (e.g., HP 70206A System Graphics Display).

STATUS INDICATORS

All elements and the mainframe have status indicators. Status indicators that inform the operator of a problem are called error indicators. Indicators that tell the user which elements are being controlled or accessed are called active indicators.

All elements, except the displays, have **ERR** (error) and **ACT** (active) indicator lights located on the front panel. Displays have indicator letters, **E** (error) and **A** (active). The display indicator letters are in the lower right corner of the display in the display status block. Some elements have additional status indicators:

- The HP 70206A System Graphics Display has an I/O error indicator light on the front panel. The I/O light should be off when both HP-MSIB cables are either connected to or disconnected from the HP 70206A System Graphics Display. It should be lit when only one HP-MSIB cable is disconnected from the HP 70206A System Graphics Display. Refer to Troubleshooting Catastrophic Failures for more information about the I/O error indicator.
- The HP 70700A Digitizer has several HP-IB related indicators: **RMT** (remote), **LSN** (listen), **TLK** (talk), and **SRQ** (service request). RMT, LSN and TLK are status indicators and do **not** indicate an error condition when they are lit. SRQ can be set by the user to light in response to different conditions (e.g., an error condition, or completion of an operation). Refer to the HP 70700A Digitizer Programming Manual for information about setting SRQ.

The HP 70001A Mainframe does not have an active indicator, but it does have three front-panel error indicators: **VOLT/TEMP**, **CURRENT**, and **I/O CHECK**. The I/O CHECK indicator should be off when both HP-MSIB cables are either connected to or disconnected from the HP 70001A Mainframe. It should be lit when only one HP-MSIB cable is connected to the HP 70001A Mainframe. Refer to the Troubleshooting Catastrophic Failures section for more information about the mainframe error indicators.

Error Indicators

The **ERR** (error) light indicates that the element has an error condition. If the element is a slave, the error lights of both the slave and its master indicate the error condition. The error lights go out when the error condition no longer exists and the error condition has been reported. (When the master has a display link, error conditions are reported to the display by an automatic error-reporting routine. If the master has a row 0 address, error conditions can also be reported using the **REPORT ERRORS** softkey in the Display screen.)

The display **E** (error) letter indicates an error condition in any element on the HP-MSIB which is on row 0, or whose master is on row 0. All elements at row 0 report their error status to the display. Masters at row 0 also report their slave error conditions to the display.

An error indicator flashing at about a 1 Hz rate indicates that the element cannot communicate on the HP-MSIB. A flashing error indicator also occurs with other errors (e.g., locking errors) that are present only when the system sweeps. In this case, the error indicator flashes at the sweep rate.

Active Indicators

The **ACT** (active) light of an element comes on when the element is being used through the display keyboard, or when the master element has told a slave to light its ACT light. Most elements also turn their ACT light on and off during their self-test.

TROUBLESHOOTING

The display **A** (active) letter comes on when [DISPLAY] is pressed, and may come on when Display screen softkeys are selected.

Each element turns its active indicator on when the cursor of the Address Map (Display screen) is at that particular element's HP-MSIB address. The HP-MSIB address of each element can be identified by scrolling the cursor through the Address Map and observing the active indicators.

ERROR MESSAGE REPORTING

Any element on the HP-MSIB that has a display link, or whose master has a display link, has its errors reported to the display through the automatic error-reporting routine.

If the element or its master has a row 0 address, the errors are also available through the use of the **REPORT ERRORS** softkey in the Display screen.

An element that is not on row address 0 reports its errors to its master; if it has the capability to interface with a display and has a display link, it can also report those errors directly to the display.

NOTE

Not all elements have the capability to interface with a display. Examples of elements with this capability are the HP 70700A Digitizer and the HP 70900A Local Oscillator.

Error Message Block

Error messages reported by the automatic error-reporting routine are written in the error message block of the display window that is assigned to the master HP 70700A Digitizer. See Figure 5-1.

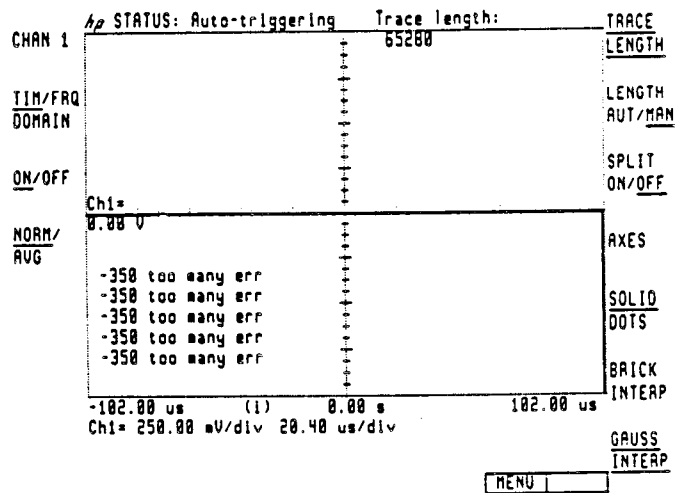

Figure 5-1. HP 70700A Digitizer Error Reporting

Each error message contains a description of the error, the error number, and the model number and address of the element with the error condition. Five error messages can be displayed at the same time.

Error Report Screen

Errors reported by any element at row address 0 can also be seen by using the **REPORT ERRORS** softkey in the Display Menu to view the Error Report screen. See Figure 5-2. The Error Report screen allows the errors to be seen whether the element has a display window or not. When **REPORT ERRORS** is pressed, the display queries all elements that are at row address 0.

The top of the Error Report screen shows the model number, description, and HP-MSIB address of the element that is reporting errors. See Figures 5-2 and 5-3.

A master (e.g., HP 70700A Digitizer) reports its errors and the errors of its slaves on the same screen. Slave error messages reported by the master show the model number and HP-MSIB address of the element that generated the error.

NOTE

When a slave reports an error, the error indicator of its master remains lit until the master reports the slave error condition, even if the slave error condition clears. When the **REPORT ERRORS** key is pressed, the master reports the error and its error indicator goes off if the slave error has cleared.

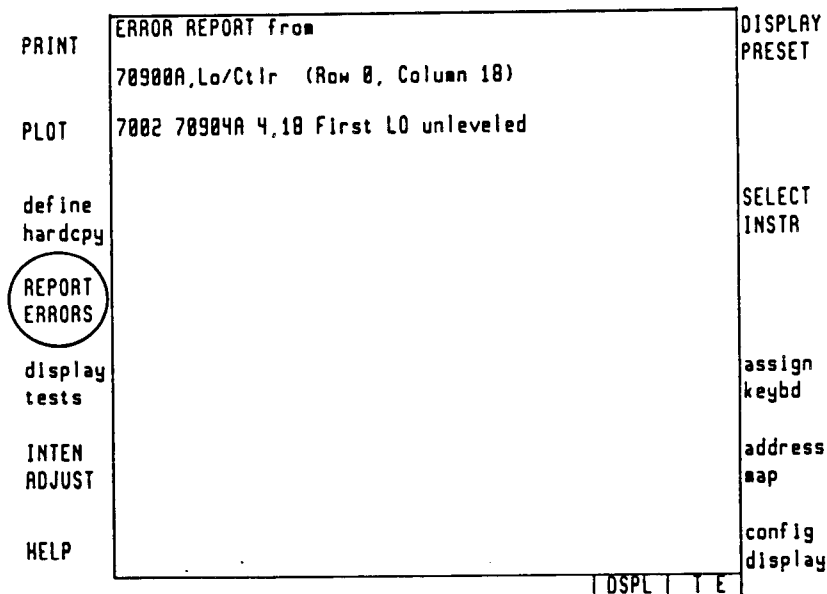

Figure 5-2. Error Report Screen

If any two elements in row 0 (including the display) are reporting errors, the Error Report screen displays the errors of the element with the lowest column address and a MORE ERRORS softkey. Pressing MORE ERRORS displays the errors of the element with the next-highest column address. See Figure 5-3.

To exit the Error Report screen, press the [USER] or [MENU] key.

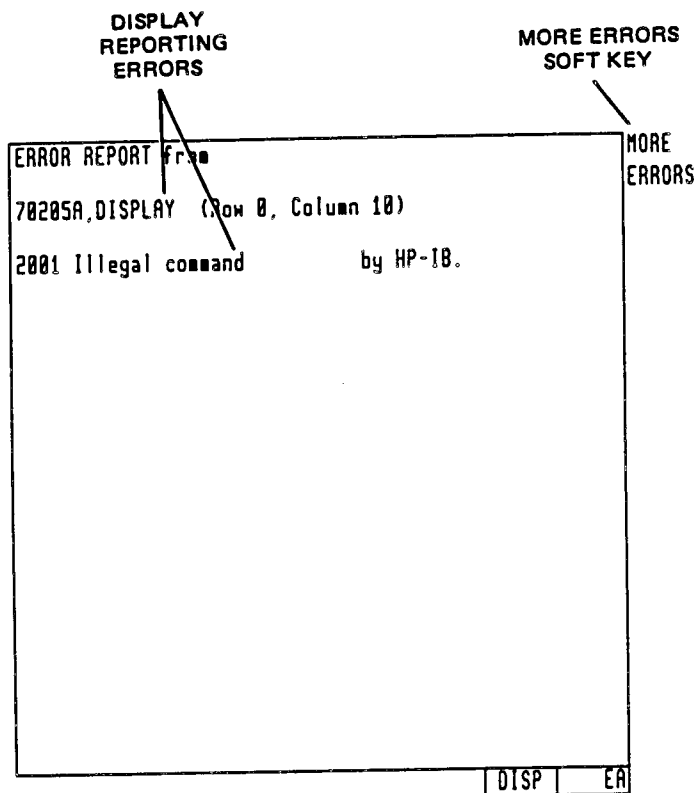

Figure 5-3. MORE ERRORS Softkey

Display-Disruptive Errors

Display error conditions that might interfere with a normal display are called display-disruptive errors. Display-disruptive error messages (e.g., A3 MEMORY READ) are written on the CRT in large block letters.

HP 70700A DIGITIZER SELF-TEST

HP 70700A Digitizer Self-Test tests the HP 70700A Digitizer analog circuits, the processor, and memory. If the self-test is run for a master HP 70700A Digitizer, both the master and its slave HP 70700A Digitizers are tested. The displays (e.g., HP 70205A) are not tested by Self-Test.

Self-Test is run automatically at instrument turn-on. It can also be run using the SELF TEST softkey by pressing [MENU], *utility*, and then SELF TEST. See Figures 5-4 and 5-5.

NOTE

Also run at turn-on is a test that checks the HP-MSIB circuits of the HP 70700A Digitizer(s) in the system.

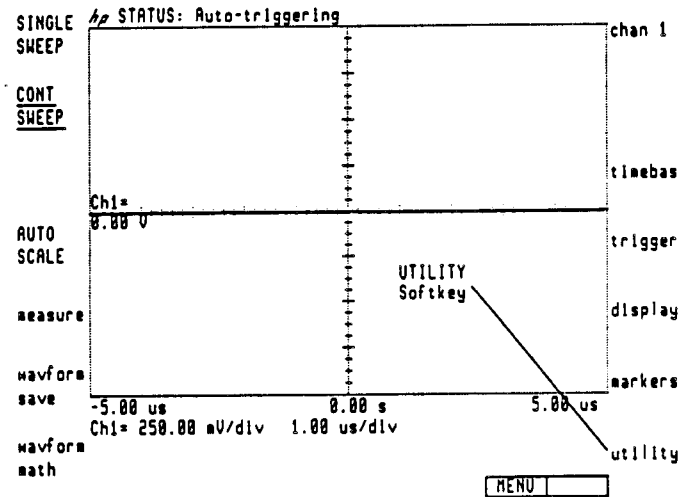

Figure 5-4. *utility* Softkey

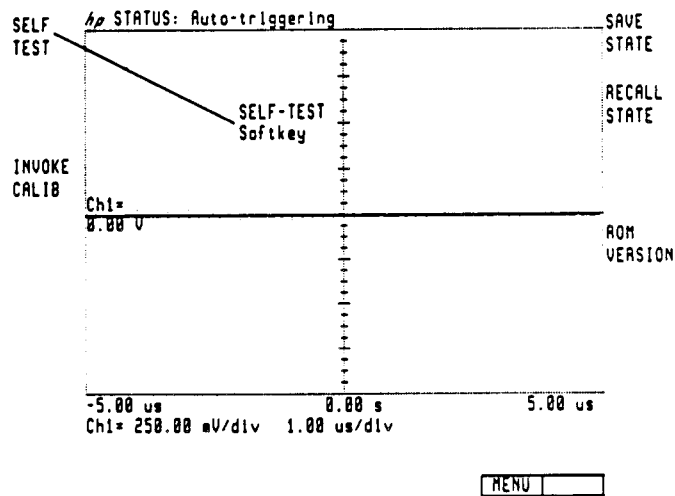

Figure 5-5. *SELF TEST* Softkey

Even if the HP 70700A Digitizer has not been assigned a display window, when Self-Test detects an error the digitizer turns on its error indicators. If the digitizer or its master is on row address 0, the display will also turn on its error indicator.

If the HP 70700A Digitizer has a display window, error messages from Self-Test are displayed in the digitizer's error message block on the display. If the HP 70700A Digitizer is addressed at row 0, Self-Test error messages can also be viewed with the Report Errors screen even if the digitizer does not have a display window or keyboard control.

DISPLAY TESTS

The Display Tests are the diagnostic and adjustment routines of the display instruments (e.g., HP 70206A). The Display Tests screen is accessed by pressing [DISPLAY], then DISPLAY TESTS. (See Figure 5-6.)

The Display Tests screen softkeys are shown in Figure 5-7 and explained in the following pages.

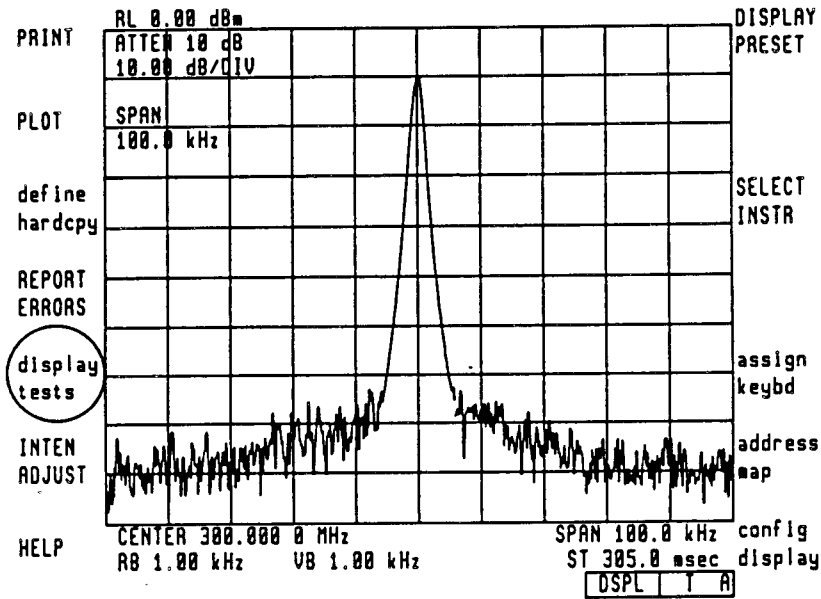

Figure 5-6. DISPLAY TESTS Softkey

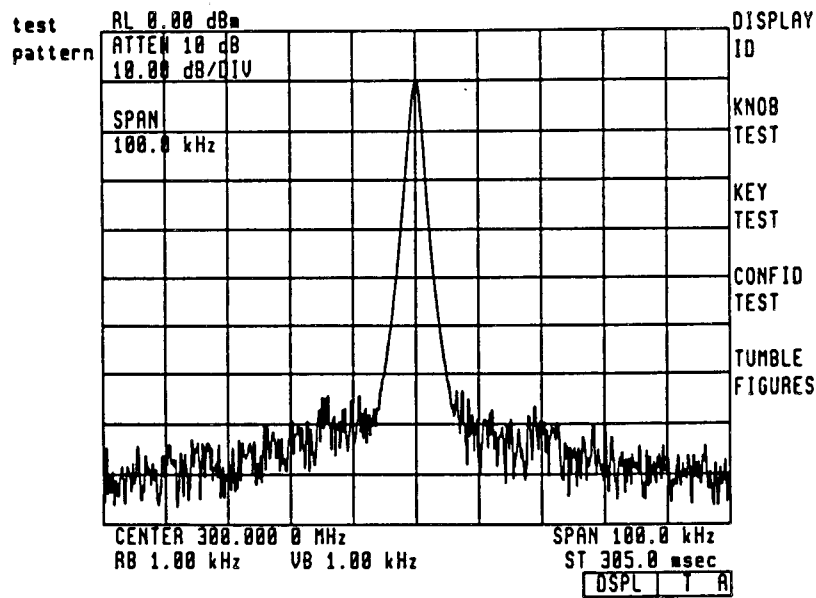

Figure 5-7. Display Tests Screen

Pattern 1, 2, 3, and 4 Softkeys

These softkeys display test patterns which are used to adjust the display. For explanations of the test patterns and related adjustments, refer to the appropriate display's Technical Reference.

Display ID Softkey

When **DISPLAY ID** is pressed, the following information is shown for the display: HP model number, firmware version, HP-MSIB address, HP-IB address, and Dot Generator release.

Knob Test Softkey

Knob Test is used to test the front-panel knob of the display instrument. It is run by pressing **[DISPLAY]**, **DISPLAY TESTS**, and then **KNOB TEST**. (See Figure 5-8.)

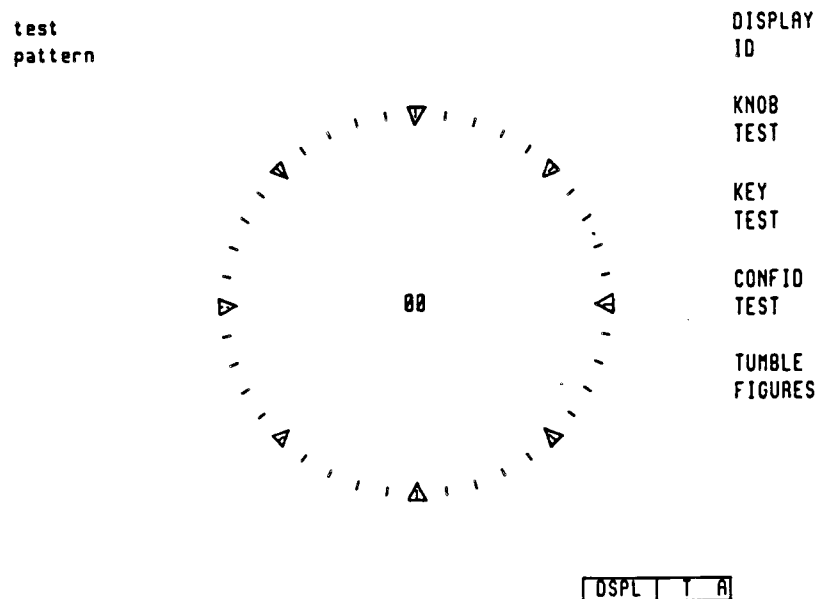

Figure 5-8. Knob Test Display

When the front-panel knob is turned clockwise slowly, the numbers in the center of the Knob Test display should increase one by one (from 00 to 39).

When the front-panel knob is turned counterclockwise slowly, the numbers in the center of the Knob Test display should decrease one by one.

If the knob is turned swiftly, the numbers should increase swiftly when the knob is turned clockwise and decrease swiftly when turned counterclockwise. (The numbers will change too quickly for you to be able to follow the one-by-one count.)

Exit the routine by pressing the back arrow key [**←**].

Tumble Figures Softkey

This softkey starts a demonstration routine. While this routine is running, the display instrument cannot communicate on either HP-IB or HP-MSIB, or respond to any front-panel keys except the back arrow key [←] and the softkeys used to select the various figures available in the Tumble Figures routine.

PERFORMANCE TESTS

HP 70700A Digitizer Performance Tests contain both tests of specified performance and functional tests. Refer to Chapter 4 for more information.

- Tests of specified performance verify that the module meets its specifications. These tests are all automated, and are required to verify calibration.
- Functional tests check the functionality of the module during troubleshooting or after a repair. Two manual and three automated functional tests are given. These tests are not required to verify calibration.

The HP 70700A Digitizer automated performance tests use the HP 70700A Digitizer Performance Test Software, which runs on HP Series 200 or 300 Computers. The primary purpose of this software is to verify that the system meets all its major specifications; however, it also contains several testing modes that are useful for troubleshooting. For example, it allows repeated testing of individual specifications, which can be useful for troubleshooting intermittent problems.

Instructions for running the manual tests are given in the Test Descriptions section of Chapter 4.

Both the automated and the manual tests require external test equipment.

HP-MSIB TROUBLESHOOTING UTILITY

The HP-MSIB Troubleshooting Utility is built into the display instrument. This utility is not automatic, and it interferes with normal system operation. Instructions for running this utility are given in the Diagnostic Procedures section of this chapter.

DIAGNOSTIC PROCEDURES

This section contains the following procedures for diagnosing problems in HP 70700A Digitizer Systems:

- Categorizing Failures
- Troubleshooting from the Front Panel
- Troubleshooting over HP-IB
- Troubleshooting Catastrophic Failures
- Using the HP-MSIB Troubleshooting Utility

If you have not already read the Troubleshooting Tools section in this chapter, read it before beginning these procedures.

CATEGORIZING FAILURES

Most system problems can be isolated using either Troubleshooting from the Front Panel or Troubleshooting over HP-IB. However, because this troubleshooting information is dependent upon running troubleshooting routines, it is not useful when there is a catastrophic failure.

Catastrophic failures prevent the system from running troubleshooting routines. These failures usually result in a blank or distorted CRT screen, flashing error lights, or no User or Menu screen softkeys.

The following procedure allows categorization of system failures, and directs you to the troubleshooting information that will be the most helpful. Before beginning this procedure, make note of any error messages that are present.

1. Cycle power and wait about ten seconds.
2. If the CRT shows a display-disruptive error, the display instrument (e.g., HP 70205A) is faulty. Refer to the appropriate Technical Reference for further troubleshooting and repair information.
3. If the User screen softkeys are shown on the CRT, the problem is not caused by a catastrophic failure. If a problem still exists, troubleshoot it using the Troubleshooting from the Front Panel or Troubleshooting over HP-IB sections on the following pages.
4. If the CRT does not show the User screen softkeys, use the following steps to assign the display window.
 - a. Press [DISPLAY].
 - b. Press **SELECT INSTR.**

NOTE

If there is more than one system on the HP-MSIB, the **SELECT INSTR** softkey assigns the display window to the master with the lowest HP-MSIB column address. If you do not want to test this master's system, press the [↑] key to select the master with the next-highest HP-MSIB column address. In this manner you can assign the display window to any system.

5. Press the [USER] key.

- a. If the User screen softkeys are shown on the CRT, the problem is not caused by a catastrophic failure. If a problem still exists, troubleshoot it using the Troubleshooting from the Front Panel or Troubleshooting over HP-IB sections on the following pages.
- b. If the User screen softkeys are still not shown, the system has a catastrophic failure. Refer to Troubleshooting Catastrophic Failures for further troubleshooting information.

NOTE

If the display window assignment is lost when the instrument is turned off, the display battery needs replacing. A dead battery will result in a **6008 Confidence Test Failed** error message at power-on and a **6002 A6 RAM Check Sum** error message when you press the **REPORT ERRORS** softkey (Display screen).

To gain access to the battery, remove the screws from the **BATTERY** cover at the rear of the stand-alone display or the display module. Battery part number information is in the System Replaceable Parts section of this chapter.

TROUBLESHOOTING FROM THE FRONT PANEL

The following procedure uses most of the troubleshooting tools of the system. Before attempting to diagnose an instrument failure, use this procedure to collect all possible clues.

1. The display instrument will be tested first. Use the procedure below to run Confidence Test, the self-test of the display instrument.
 - a. Press [DISPLAY].
 - b. Press **DISPLAY TESTS**.
 - c. Press **CONFID TEST**.
 - d. The display indicates on the CRT title line whether the Confidence Test passed or failed. If the Confidence Test failed, press **REPORT ERRORS**. Record the errors and refer to the appropriate display's Technical Reference to repair the faulty display instrument. If the Confidence Test passed, continue with this procedure.

2. The HP 70700A Digitizer is tested using its Self-Test. Use the following procedure to run Self-Test. When Self-Test is run for a master HP 70700A Digitizer, both the master and its slaves are tested.
 - a. Press [MENU].
 - b. Press **utility**.
 - c. Press **SELF TEST**. Record any error messages, including HP-MSIB addresses, that are shown in the error message block of the display. Use the error messages, including addresses, to identify the faulty digitizer. Refer to the HP 70700A Digitizer Technical Reference for further troubleshooting information.

If no error messages were generated by the procedure and you still suspect an instrument failure, run the performance tests to verify that the system meets its specifications. Refer to Chapter 4 for instructions.

TROUBLESHOOTING OVER HP-IB

Troubleshooting over HP-IB is recommended only if you do not have access to a display instrument (e.g., HP 70205A).

The following remote commands can be used from an external HP-IB computer.

***TST?** begins the Self-Test routine of the HP 70700A Digitizer. The response will be either **PASS** or **FAIL**.

ERR?~STR query returns a text description of one error. If there is more than one error, repeat the query until all the errors have all been seen.

The above commands and their syntax are described in the HP 70700A Digitizer Programming Manual.

TROUBLESHOOTING CATASTROPHIC FAILURES

Catastrophic failures prevent the system from running most troubleshooting routines. These failures usually result in an abnormal CRT screen, no User or Menu screen softkeys, or flashing error lights.

NOTE

Before troubleshooting a catastrophic failure, verify that the correct line power is applied to the mainframe (and stand-alone display, if used). The mainframe power-on indicator should light when the LINE switch is turned on. If the power-on indicator does not light, refer to the HP 70001A Mainframe Technical Reference for troubleshooting information.

Abnormal CRT Screen

Troubleshooting information is given below for the following symptoms: blank or distorted CRT display, message written in large block letters on the CRT display, and the CRT showing the Display ID screen.

A blank or distorted CRT display

If a display module (e.g., HP 70205A) has a blank or distorted CRT display after power to the system is cycled, the display module is faulty. Refer to the appropriate Technical Reference for further troubleshooting and repair information.

If a stand-alone display (e.g., HP 70206A) has a blank or distorted CRT display, disconnect the HP-MSIB cables and cycle power on the stand-alone display. If the CRT is still blank or distorted, the stand-alone display is faulty. Refer to the appropriate Technical Reference for repair information.

CRT blank except for a message written in large block letters

The message is a display-disruptive message. It indicates a faulty display instrument. Refer to the appropriate Technical Reference for repair information.

CRT shows Display ID screen

The Display ID screen shows the following information about the display instrument: model number, firmware version, HP-MSIB address, HP-IB address, and Dot Generator release date. If this information is shown on the CRT, either the display window is not assigned to a master, or the display cannot talk to a master.

Assign the display window to a master by pressing [DISPLAY], then SELECT INSTR. This assigns the display to the master with the lowest column address. Press the [↑] key to assign the display to the master with the next-highest address.

If the display window cannot be assigned to a master, then a module with a faulty HP-MSIB interface is hanging up the system, or the HP-MSIB or master element is faulty. Refer to Using the HP-MSIB Troubleshooting Utility to further troubleshoot the problem.

NOTE

If the display window assignment is lost when the instrument is turned off, the display battery needs replacing. A dead battery will result in a 6008 Confidence Test Failed error message at power-on and a 6002 A6 RAM Check Sum error message when you press the REPORT ERRORS softkey (Display screen).

To gain access to the battery, remove the screws from the BATTERY cover at the rear of the stand-alone display or the display module. Battery part number information is in the Replaceable System Parts section of this chapter.

Missing User or Menu Screen Softkeys

If the User or Menu screen softkeys are missing, press [DISPLAY], then SELECT INSTR to assign the display window to the master with the lowest column address. Press the [↑] key to assign the display to the master with the next-highest address.

Press [USER] or [MENU]. If the User or Menu screen softkeys are still missing, refer to Using the HP-MSIB Troubleshooting Utility to further troubleshoot the problem.

Error Lights

Troubleshooting information is given below for the following symptoms: flashing **E** (error) letter or ERR (error) light, lit I/O indicator on an HP 70206A System Graphics Display, and lit VOLT/TEMP, CURRENT, or I/O CHECK on an HP 70001A Mainframe.

Flashing **E** (error) letter or ERR (error) light

If the **E** letter or the ERR light of an element flashes at a 1 Hz rate, the element cannot talk on the HP-MSIB and is probably faulty. If more than one module flashes its error indicator at a 1 Hz rate, either the mainframe HP-MSIB is faulty, a faulty module is disrupting the whole HP-MSIB, or the HP-MSIB cables are faulty. (It is possible, but not probable, for a module to disrupt the whole HP-MSIB without flashing its own error indicator.) Refer to Using the HP-MSIB Troubleshooting Utility to further isolate the problem.

The I/O indicator on the HP 70206A System Graphics Display is lit

The HP 70206A System Graphics Display I/O indicator light should be off when both HP-MSIB cables are either connected to or disconnected from the HP 70206A. It should be lit when only one HP-MSIB cable is connected to the HP 70206A. Follow the troubleshooting procedure below to isolate other causes of the I/O indicator being lit:

1. Verify that all mainframes and stand-alone displays on the HP-MSIB have their power turned on.
2. Check for proper HP-MSIB cable connections, making sure that all cable connections are secure.
3. Disconnect the HP-MSIB cables from the HP 70206A.
 - a. If the I/O indicator is still lit, the HP 70206A System Graphics Display is faulty. Refer to the HP 70206A System Graphics Display Technical Reference for further troubleshooting and repair information.
 - b. If the I/O indicator is not lit, the problem is either in the cables or in the instrument that was connected by the cables to the HP 70206A System Graphics Display. Reconnect the HP-MSIB cables and use the HP-MSIB Troubleshooting Utility to further isolate the problem.

NOTE

If any of the elements respond to the HP-MSIB Troubleshooting Utility with **COMMUNICATION COMPLETE**, the cables are not faulty.

HP 70001A Mainframe VOLT/TEMP indicator is lit

The VOLT/TEMP indicator usually lights because the input voltage is too low or the internal temperature on the mainframe power-supply board assembly exceeds the normal operating temperature.

1. Check the **LINE VOLTAGE SELECTOR** on the bottom of the mainframe to make sure the selector setting matches the line voltage.
2. Allow the instrument to cool. If the temperature decreases to normal operating range, the mainframe will attempt to restart itself. After the instrument has restarted, verify that the cooling fans are operating by visually checking the airflow into both fan-intake openings in the rear panel of the mainframe.

If neither of the above steps result in correction of the problem, the HP 70001A Mainframe is faulty. Refer to the HP 70001A Mainframe Technical Reference for further troubleshooting and repair information.

HP 70001A Mainframe CURRENT indicator is lit

The **CURRENT** indicator lights when a module in the mainframe is drawing too much current.

1. Remove one module from the mainframe.
2. Cycle the power.
 - a. If the **CURRENT** indicator is no longer lit, the module is faulty. Verify this by replacing the module in the mainframe and seeing if the **CURRENT** indicator lights again. Refer to the appropriate Technical Reference for repair information.
 - b. If the **CURRENT** indicator is still lit, the module is not faulty. Repeat steps 1 and 2 until a faulty module is identified.
3. If the **CURRENT** indicator is still lit when all of the modules have been removed from the mainframe, the mainframe is faulty. Refer to the HP 70001A Mainframe Technical Reference for further troubleshooting information.

HP 70001A Mainframe I/O CHECK indicator is lit

The **I/O CHECK** light should be off when both HP-MSIB cables are either connected to or disconnected from the HP 70001A Mainframe. It should be lit when only one HP-MSIB cable is connected to the mainframe.

To isolate other causes of the **I/O CHECK**'s being lit, use the following procedure.

1. Verify that all mainframes and stand-alone displays on the HP-MSIB have their power turned on.
2. Check for proper HP-MSIB cable connections, making sure that all cable connections are secure.
3. Disconnect the HP-MSIB cables from the mainframe.
 - a. If the **I/O CHECK** light is still lit, the HP 70001A Mainframe is faulty. Refer to the HP 70001A Mainframe Technical Reference for further troubleshooting information.
 - b. If the **I/O CHECK** light is no longer lit, the problem is either in the cables or in the instrument that was connected by the cables to the mainframe. Reconnect the HP-MSIB cables, and refer to Using the HP-MSIB Troubleshooting Utility to further isolate the problem.

NOTE

If an element outside of the mainframe responds to the HP-MSIB Troubleshooting Utility with **COMMUNICATION COMPLETE**, the cables are not faulty.

USING THE HP-MSIB TROUBLESHOOTING UTILITY

The HP-MSIB Troubleshooting Utility is a firmware routine of the display instrument. It allows you to verify that an element can communicate on the HP-MSIB. By determining which elements can communicate, you can isolate the HP-MSIB problem. However, if the problem is in the mainframe or the display, the utility cannot determine which is faulty.

Preparing to Use the Utility

To use the utility, you must know the HP-MSIB addresses of the elements. It is recommended that you keep a written list of the HP-MSIB addresses.

NOTE

The address map may not function if there is an HP-MSIB problem. After an HP-MSIB problem occurs, the Address Map cannot be relied on to determine the addresses of the elements.

If you do not know the HP-MSIB addresses, they can be identified by checking the switch settings on each module. (Softset master-module addresses cannot be verified this way.) The HP-MSIB addresses can also be deduced from the HP-IB address of the master, the response of the troubleshooting utility, and the addressing rules given in the HP-MSIB/HP-IB Addressing section of Chapter 2.

NOTE

The HP-MSIB Troubleshooting Utility inhibits normal operation of the system. Using the utility may put the system in a state from which you can only recover by cycling power.

When the HP-MSIB is not working, the troubleshooting utility cannot be used unless the display is prevented from automatically communicating with other HP-MSIB elements. This is done by purging ALL window assignments of the display.

The **SHOW CONFIG** softkey of the Display screen shows which windows are assigned. Use the following procedure to purge window assignments.

1. Press the [DISPLAY] key.
2. Press **CONFIG DISPLAY**.

3. Press PURGE WINDOW.
4. Select the window to be purged by pressing the [↑] or [↓] key. (The window number selected is shown at the lower left-hand corner of the screen.)
5. Press EXECUTE to purge the window.
6. Repeat steps 2 through 5 until all windows are purged.
7. Cycle power.

When all window assignments are purged the User screen will be blank, except for the status block.

Using the Utility

Use the following procedure to access the HP-MSIB Troubleshooting Utility.

1. Press [DISPLAY].
2. Press DISPLAY TESTS, then KNOB TEST. The CRT display should be similar to the one shown in Figure 5-10. Note that the Knob Test value is 00.
3. With the Knob Test value at 00, press the lower left-hand softkey (unlabeled).

The HP-MSIB Troubleshooting Utility is now displayed as illustrated in Figure 5-11. This utility is entered through an unlabeled softkey to prevent users from accidentally disrupting normal system operation.

test
pattern

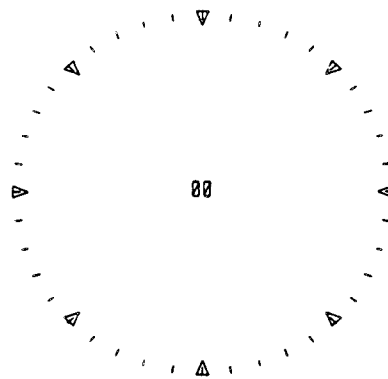

DISPLAY
ID

KNOB
TEST

KEY
TEST

CONFID
TEST

TUMBLE
FIGURES

DSP | Y | A

Figure 5-10. Knob Test Display

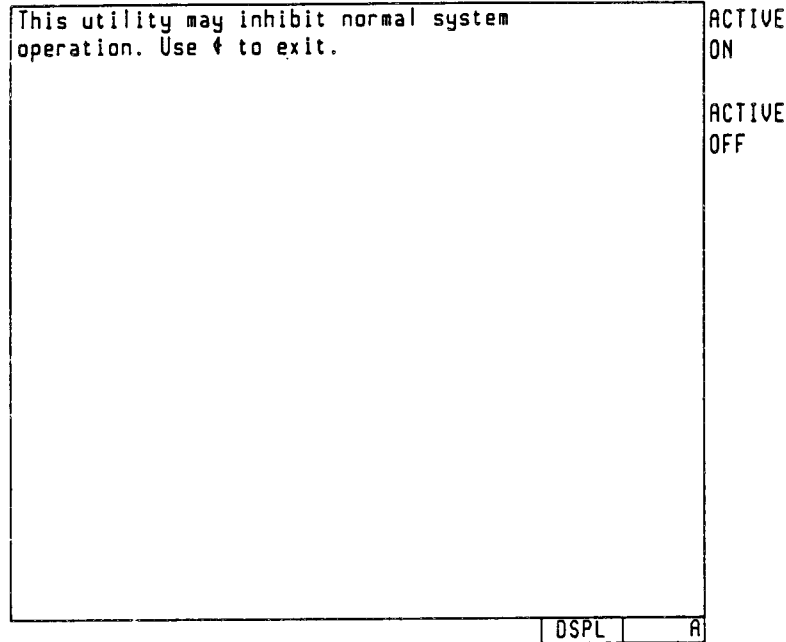

Figure 5-11. HP-MSIB Troubleshooting Utility

The utility has two main softkeys: *ACTIVE ON* and *ACTIVE OFF*. (See Figure 5-11.) These softkeys send the HP-MSIB command to turn the active indicator of an element on and off.

Once the command is sent, the display examines the HP-MSIB to see if the element received the instruction. Use the following procedure to send the Active On command.

1. Press *ACTIVE ON*.

NOTE

The *MODULE NOT ACCEPTING DATA* message is returned for a master module if one of its slaves has a faulty HP-MSIB interface. Therefore, verify that all of the slaves of a master can communicate before determining that the master is unable to communicate.

2. Using the numeric key pad, enter the row address of the module that is to be tested for an HP-MSIB failure.
3. Press *ENTER*.
4. Enter the column address of the module as a hexadecimal number. Refer to Table 5-1 for decimal-to-hexadecimal conversion information. Use the alphabetical softkeys (Figure 5-12) and the key pad to enter the hexadecimal numbers.
5. Press *ENTER*.

Table 5-1. Decimal/Hexadecimal Conversion

Decimal	Hexadecimal	Decimal	Hexadecimal
0	0	16	10
1	1	17	11
2	2	18	12
3	3	19	13
4	4	20	14
5	5	21	15
6	6	22	16
7	7	23	17
8	8	24	18
9	9	25	19
10	A	26	1A
11	B	27	1B
12	C	28	1C
13	D	29	1D
14	E	30	1E
15	F	31	1F

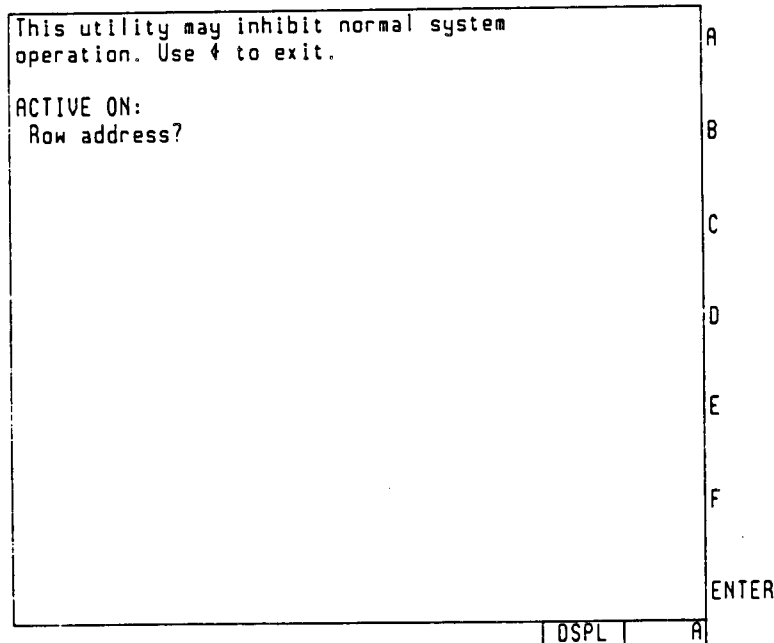

Figure 5-12. Alphabetical Softkeys

The utility has a two-second timeout. Allow two seconds for the utility to respond to the ENTER softkey. The utility responds by displaying one of the following messages. (Example messages are shown in Figure 5-13.)

Module not accepting data. This message indicates that there is an element at the specified address, but it cannot communicate on the HP-MSIB.

Communication complete. This message indicates the HP-MSIB of the element works correctly. Note that the active light of the module should be ON.

Module not present. This message indicates that there is no element at the specified address.

```
This utility may inhibit normal system
operation. Use ↑ to exit.

ACTIVE ON:
  Row address? 4
  Column address? 5
  Module not present.

ACTIVE ON:
  Row address? 1
  Column address? 1C
  Communication complete

ACTIVE OFF:
  Row address? 1
  Column address? 1C
  Communication complete

A
B
C
D
E
F
ENTER
DSPL A
```

Figure 5-13. Completed HP-MSIB Communication

Interpreting the Utility Results

If only one module cannot communicate on HP-MSIB, that module is faulty. Refer to the appropriate Technical Reference for troubleshooting and repair information.

If none of the elements on the HP-MSIB can communicate, either a module is disrupting the entire HP-MSIB, the mainframe HP-MSIB circuits are faulty, or the display instrument has a faulty HP-MSIB interface and the utility is giving erroneous results. Use the following steps to further isolate the problem.

1. If an abnormal CRT screen is a symptom, refer to both the HP 70001A Mainframe Technical Reference and to the appropriate display Technical Reference for further troubleshooting and repair information.
2. If flashing error lights are a symptom, the faulty element or mainframe can be isolated by using the steps given below.

NOTE

If a module is under test, turn the mainframe OFF before removing the module from the mainframe.

- a. Remove the element from the HP-MSIB by removing the module from the mainframe, or by disconnecting the HP-MSIB cables from a stand-alone element.

- b. Cycle the power.
- c. If the problem is gone, the element is faulty. Refer to the appropriate Technical Reference for further troubleshooting and repair information.
- d. If the problem remains, repeat steps a through c until the faulty element has been isolated. If none of the elements are faulty, the HP 70001A Mainframe is faulty. Refer to the HP 70001A Mainframe Technical Reference for further troubleshooting and repair information.

ERROR CODES

This section contains error code information for the HP 70700A Digitizer. Typical error codes for displays (e.g., HP 70205A) are also listed. For more error code information for your specific display, or for error codes generated by other elements, refer to the appropriate Installation and Verification Manual or Technical Reference.

HP 70700A DIGITIZER ERROR CODES

HP 70700A Digitizer error codes with negative numbers have HP-SL (Hewlett-Packard Systems Language) defined categories. Error codes with positive numbers are device-dependent.

Descriptions of the functional types for both negative and positive error codes are given below. All error types report the model number and HP-MSIB address along with the error message.

Negative Error Codes

Types	Numbers
Command	-100 to -199
Execution	-200 to -299
Internal/Hardware	-300 to -399
Query	-400 to -499

Positive Error Codes

Types	Numbers
No Errors	0000
Usage/Operating	2000 to 2999
Hardware Warning	6000 to 6999
Hardware Broken	7000 to 7999

The error codes generated by the HP 70700A Digitizer are listed below in numerical order. A brief description of the error meaning is given. For most positive-number hardware errors, the reference designator and board assembly name (e.g., A3 Address board assembly) for the HP 70700A Digitizer board assembly most likely to have caused the error are also given.

Negative Error Codes

Command Errors

These errors are generated when the module cannot understand a remote programming message.

--100 unrec cmd (unrecognized command) A command not in the device command table was received.

- 101 **inval chr** (invalid character) A non-numeric parameter is unrecognized or not valid.
- 110 **cmd hdr** (command header) There was an error in a command header.
- 111 **hdr delim** (header delimiter) The wrong header delimiter was received. The module expected ":".
- 120 **num arg** (numerical argument) There is a problem with a numeric argument.
- 121 **exp num** (expected numeric) The device expected a numeric argument instead of what it received.
- 123 **num ovflw** (number overflow) The number received exceeds the internal representation format of the device.
- 129 **miss num** (missing numeric) A numeric argument was required, but not received.
- 130 **non-num arg** (non-numeric argument) There is a problem with a non-numeric argument.
- 131 **exp chr** (expected character) The device expected a single character.
- 132 **exp str** (expected string) The device expected a string (i.e., "text" or 'text').
- 133 **exp bin** (expected binary) The device expected a binary parameter (i.e., #x...).
- 134 **too long** (too long) The parameter(s) are too long (e.g., a string longer than 31 characters).
- 139 **miss non-num** (missing non-numeric) A non-numeric parameter was required, but not received.
- 142 **too many arg** (too many arguments) More arguments were received than were expected.
- 143 **arg delim** (argument delimiter) The wrong argument delimiter was received. (Generally, ";" is expected.)
- 144 **mess delim** (message delimiter) The wrong message delimiter was received. (<LF> or <END> is expected.)

Execution Errors

These errors occur when the device cannot successfully perform an operation requested from the remote interface.

- 200 **ex err** (execution error) There is an execution error.
- 201 **not ex in lcl** (not executable in local) This command is not executable when the device is in local.
- 202 **set lost** (settings lost) Due to the execution of this command, some settings were lost.
- 203 **trig ign** (trigger ignored) The trigger condition was ignored.

- 211 **set confl** (setting conflict) This command is in conflict with other device settings.
- 212 **arg rng** (argument range) The numeric argument(s) are outside the acceptable range of settings for this command.
- 221 **busy** (busy) The device is too busy to execute the command (e.g., asking the module to save two waveforms at once).
- 222 **insuf capab** (insufficient capability) The device does not have enough capability, or the correct configuration, to execute this command.
- 232 **out buf full** (output buffer full) The output buffer (I/O) is full.

Internal/Hardware Errors

These error messages indicate that there is a hardware problem that prevents operation.

- 300 **hrdwr** (hardware) There is a problem with the hardware.
- 301 **intr** (interrupt) There is a failure of the interrupt system.
- 302 **sys err** (system error) There is a problem with the system.
- 303 **time out** (time out) The instrument is timed out.
- 310 **RAM addr** (RAM address) The address bus on the A5 Processor board assembly is of questionable integrity.
- 311 **___ data** (U31 data) or (U32 data) The U31 or U32 RAM failed a data read/write test.
- 312 **data (batt?)** (data [battery?]) Some or all of the data in the battery-backed-up RAM has been lost. (This is checked at power-on.)
- 321 **___ chksm** (U43 checksum) or (U44 checksum) The U43 or U44 ROM failed its checksum test.
- 322 **incompatible** (incompatible) The hardware in the device is not compatible with the firmware.
- 330 **PON test** (power-on test) The self-test executed at power-on failed.
- 340 **self test** (self test) The self-test failed.
- 350 **too many err** (too many errors) There are too many errors to fit into the error buffer. All subsequent errors are lost.

Query Errors

These errors occur when the instrument receives an incorrect query or one that it cannot understand.

- 400 **qry** (query) The query is incorrect or incomplete.
- 410 **qry intr** (query interrupted) The query was interrupted.
- 420 **qry unt** (query unterminated) The query is unterminated.
- 421 **in prog** (in progress) The query is in progress.
- 422 **empty** (empty) The device was addressed to talk, but it has nothing to say.
- 430 **deadlock** (deadlock) The I/O buffers are full, and the device cannot do anything without destroying commands or data.

Positive Error Codes

- 0000 **No errors** (no errors) There are no errors.

Usage/Operating Errors

These errors occur when the instrument is used incorrectly.

- 2100 **unsupported** (unsupported) The command received is executable, but not guaranteed to work with all revisions of firmware.

Hardware Warning Errors

These error messages tell the status of the HP 70700A Digitizer hardware or indicate that some hardware of the HP 70700A Digitizer may be broken. Instrument function may be impaired.

- 6200 **discont time** (discontinuity timing) During an REC (random-event capture) measurement, the time between two triggers exceeded the hardware's ability to record the data. (This is a measurement error.)
- 6201 **unstable** (unstable) This error occurs during the ETS (Equivalent Time Sampling) mode when the input signal is too unstable to be usable. (Hardware or user error)
- 6202 **submultiple** (submultiple) This error occurs during the ETS (Equivalent Time Sampling) mode when the input signal is too close to a submultiple of the sampling rate to be usable. (Hardware or user error)
- 6203 **inval trace:** (invalid trace) This error occurs when an attempt has been made to access a trace that does not have any data.
- 6204 **autoscale** (autoscale) The autoscale function could not find a stable signal.
- 6327 **time ram: 1** (time RAM: 1) The time RAM did not pass the "ones" test. (A3 Address Board)

- 6328 time ram: 0** (time RAM: 0) The time RAM did not pass the "zeros" test. (A3 Address board assembly)
- 6329 time cntr, ram** (time counter, RAM) The time counter or RAM is not working properly. (A3 Address board assembly)
- 6330 add1** (add1) The add1 line is not working. (A3 Address board assembly)
- 6331 1st time ram #** (first time RAM number) The delay time of the time RAM is in error. (A3 Address board assembly)
- 6332 tm rm post trig n 0** (time RAM post trigger not zero) The test expected to see zeros in the time RAM at this point in the test. (A3 Address board assembly)
- 6333 tm rm time bet trigs wrng** (time RAM time between triggers wrong) The time RAM sequence is not as was expected. (A3 Address board assembly)
- 6334 too many trigs** (too many triggers) The hardware received too many triggers. (A3 Address board assembly)
- 6350 adc bit stuck low:** _____ (adc bit stuck low:) (Behind the error message is the number, from 0 to 9, of the suspected bit.) This error is caused by bits in the data path being stuck low, or a bad offset DAC. (A4 Converter board assembly)
- 6351 adc bit stuck high:** _____ (adc bit stuck high:) (Behind the error message is the number, from 0 to 9, of the suspected bit.) This error is caused by bits in the data path being stuck high, or a bad offset DAC. (A4 Converter board assembly)
- 6353 mem addr low bits** (memory address low bits) This error means that memory addressing error(s) exist. (A4 Converter board assembly)
- 6354 +pk det** (positive peak detector) The positive peak detector is not working. (A4 Converter board assembly)
- 6355 -pk det** (negative peak detector) The negative peak detector is not working. (A4 Converter board assembly)
- 6356 +pk det n reset** (positive peak detector not reset) The positive peak detector did not reset when it should have. (A4 Converter board assembly)
- 6357 -pk det n reset** (negative peak detector not reset) The negative peak detector did not reset when it should have. (A4 Converter board assembly)
- 6358 dets n equal** (detectors not equal) The positive peak and negative peak detectors are not clocking at the same value. (A4 Converter board assembly)
- 6359 gain< >3** (gain is less than or greater than 3) "Gain=3" has an error. (A4 Converter board assembly)
- 6360 gain< >1** (gain is less than or greater than 1) "Gain=1" has an error. (A4 Converter board assembly)

-
- 6361 gain < >.1** (gain is less than or greater than .1) "Gain=.1" has an error. (A4 Converter board assembly)
- 6362 gain < >.3** (gain is less than or greater than .3) "Gain=.3" has an error. (A4 Converter board assembly)
- 6363 pos slope hyst** (positive slope hysteresis) There is a problem with positive slope hysteresis. (A4 Converter board assembly)
- 6364 pos slope trig** (positive slope trigger) There is a problem with the positive slope trigger. (A4 Converter board assembly)
- 6365 neg slope hyst** (negative slope hysteresis) There is a problem with the negative slope hysteresis. (A4 Converter board assembly)
- 6366 neg slope trig** (negative slope trigger) There is a problem with the negative slope trigger. (A4 Converter board assembly)
- 6367 abv lvl trig n reset** (above-level trigger not reset) The above-level triggering is not resetting. (A4 Converter board assembly)
- 6368 abv lvl trig** (above level trigger) The above-level triggering is not setting. (A4 Converter board assembly)
- 6370 bel lvl trig n reset** (below-level trigger not reset) The below-level trigger is not resetting. (A4 Converter board assembly)
- 6371 bel lvl trig** (below-level trigger) The below-level trigger is not setting. (A4 Converter board assembly)
- 6373 REC trig reset** (random-event-capture trigger reset) The REC (random-event capture) trigger is not resetting. (A4 Converter board assembly)
- 6382 clk >.1 uS** (clock greater than .1 μ s) At PON (power-on) or CALIBRATION, the measured period of the clock into the HP 70700A Digitizer is too slow.
- 6384 gain cal** (gain calibration) The gain calibration failed. (hardware)
- 6385 pgm lost** (program lost) Some or all of the program contained in the HP 70700A Digitizer's RAM has been lost. (Possible failure of the battery on the A5 Processor board assembly.)
- 6386 pgm inval** (program invalid) The HP 70700A Digitizer ROM and RAM code are not compatible. (A5 Processor board assembly or firmware)
- 6387 prg ovrlp** (program overlap) The last attempt to load RAM tried to overwrite an existing program. (A5 Processor board assembly or software)
- 6388 prg gone** (program gone) An attempt has been made to access a program that is not loaded in RAM. (A5 Processor board assembly or software)
- 6391 wait state** (wait state) The wait state generator on the A5 Processor board assembly is generating an incorrect number of wait states.
-

Hardware Broken Errors

These error messages indicate that the HP 70700A Digitizer has faulty firmware or hardware.

- 7301 uP bus, wr addr:** _____ (microprocessor bus, write address:) (Behind the error message is the number, from 0 to 19, of the suspected bit.) This error occurs when there is a microprocessor bus, or write address, problem. (A3 Address board assembly)
- 7302 rd addr, inh rd:** _____ (read address, inhibit read:) (Behind the error message is the number, from 0 to 19, of the suspected bit.) This error occurs when there is a microprocessor-bus, or read address, problem. (A3 Address board assembly)
- 7303 shld addr, inh wr:** _____ (shield address, inhibit write:) (Behind the error message is the number, from 0 to 19, of the suspected bit.) This error occurs if the "inhibit write" is not set when the shield address and the write address are the same.
- 7304 seg size short:** _____ (segment size short) (Behind the error message is the number, from 0 to 19, of the suspected bit.) The segment size is too short or the wrap address is wrong. (A3 Address board assembly)
- 7305 seg size long:** _____ (segment size long) (Behind the error message is the number, from 0 to 19, of the suspected bit.) The segment size is too long or the wrap address is wrong. (A3 Address board assembly)
- 7306 inh rd n reset** (inhibit read not reset) The inhibit read was not reset. (A3 Address board assembly)
- 7307 inh wr n reset** (inhibit write not reset) The inhibit write was not reset. (A3 Address board assembly)
- 7308 wr addr n count** (write address not counting) The write counters are not working. (A3 Address board assembly)
- 7309 cps cntr early** (clocks-per-sample counter early) The clocks-per-sample counter is early. (A3 Address board assembly)
- 7310 cps cntr late** (clocks-per-sample counter late) The clocks-per-sample counter is late or not counting. (A3 Address board assembly)
- 7311 trig n reset @ uP** (trigger not resetting at microprocessor) The trigger is not resetting at the microprocessor. (A3 Address board assembly)
- 7312 trig n set @ uP** (trigger not setting at microprocessor) The trigger is not setting at the microprocessor. (A3 Address board assembly)
- 7313 WAT timeout early** (writes-after-trigger timeout early) The WAT (writes-after-trigger) timeout is early. (A3 Address board assembly)
- 7314 WAT timeout late** (writes-after-trigger timeout late) The WAT (writes-after-trigger) timeout is late or absent. (A3 Address board assembly)
- 7315 wr addr n stop @ EOS** (write address not stop at end-of-segment) The write address did not stop incrementing at EOS (end-of-segment). (A3 Address board assembly)

-
- 7316 WAT cntr n stop @ EOS** (writes-after-trigger counter not stop at end-of-segment) The WAT (writes-after-trigger) counter did not stop incrementing at EOS (end-of-segment). (A3 Address board assembly)
- 7317 cps stuck @ 1** (clocks-per-sample stuck at 1) The clocks-per-sample counter is stuck at 1. (A3 Address board assembly)
- 7318 cps bad load** (clocks-per-sample bad load) The clocks-per-sample counter is not loading properly. (A3 Address board assembly)
- 7319 WAT n wait for trig** (writes-after-trigger not wait for trigger) The WAT (writes-after-trigger) counter did not wait for the trigger. (A3 Address board assembly)
- 7320 WAT n strt by trig** (writes-after-trigger not started by trigger) The WAT (writes-after-trigger) counter was not enabled by the trigger. (A3 Address board assembly)
- 7321 WAT n reload** (writes-after-trigger not reload) The WAT (writes-after-trigger) counter did not reload. (A3 Address board assembly)
- 7322 wr addr, WAT lsbs** (write address, writes-after-trigger least significant bits) There is a problem with the write address or WAT (writes-after-trigger) counter least significant bits. (A3 Address board assembly)
- 7323 trace n wait for trig** (trace not wait for trigger) The trace is starting before the trigger is received. (A3 Address board assembly)
- 7324 trace n strt by trig** (trace not start by trigger) The trace did not start when the trigger was received. (A3 Address board assembly)
- 7325 timebase switch-early** (timebase switch — early) The sample clock was disabled and the write address frozen before they should have been. ("inhibit write" on the A3 Address board assembly.)
- 7326 timebase switch-late** (timebase switch — late) The sample clock was not disabled when it should have been. ("inhibit write" on the A3 Address board assembly.)
- 7389 HP-MSIB err** (HP-MSIB error) The HP 70700A Digitizer is having problems communicating over HP-MSIB. (HP 70700A Digitizer A5 Processor board assembly, system cabling, or system mainframe)
- 7390 U21 via** (U21 via) The test of the U21 VIA (versatile interface adapter) chip failed. (A5 Processor board assembly)
- 7392 miss clk** (missing clock) No clock to the HP 70700A Digitizer was found.
-

DISPLAY ERROR CODES

Listed below are typical error codes for displays (e.g., HP 70205A Graphics Display). This information is intended to be representative of the display errors encountered. For more current information, or information about an error code not listed below, refer to the appropriate Installation and Verification Manual or Technical Reference for the specific display.

The error messages generated by the displays are divided into the following functional types; each type has its own series of numbers.

Types	Numbers
Operating	2000-2999
Hardware-Warning	6000-6999
Hardware-Broken	7000-7999
Display-Disruptive	not applicable

Except for the Display-Disruptive errors, all error types also report the display model number and HP-MSIB address along with the error message.

Operating Errors

These error messages are generated when the instrument is used incorrectly, usually during remote operation.

- 2001 illegal command (or illegal cmd)
- 2002 illegal parameter
- 2005 illegal character set
- 2006 Parm out of range Parameter out of range
- 2007 Missing terminator
- 2009 Protocol error
- 2011 Memory overflow

Hardware-Warning Errors

These error messages tell the status of the display hardware or indicate that some hardware of the display may be broken. Display instrument function may be impaired, but this should not affect operation of the other elements in the system.

- 6001 Confidence test passed The display passed its confidence test.

-
- 6002 A6 RAM checksum (battery?)** The RAM checksum on the A6 board assembly of the display has an error. This error may be the result of the display battery's needing replacement.
- 6008 Confidence test failed** The display failed its confidence test.

Hardware Broken Errors

These error messages indicate that the display has faulty hardware.

- 7036 HP-MSIB error** The display is having a problem communicating over HP-MSIB.
- 7037 A3 Character set** The test of the display A3 board assembly character set failed.
- 7038 A6 error in 8041** The display A6 board assembly has an error.
- 7039 A4 memory** The display A4 board assembly has a memory error.
- 7040 A3 dot gen** The display A3 board assembly has a dot generator error.
- 7048 A3 Wrong datecode** The display A3 board assembly has a datecode error.
- 7049 A3 Character ROM** The display has a character ROM problem.
- 7050 A3 Sub return** The display attempted a subroutine and then failed to return to the correct line in the program.
- 7051 A3 Instruction mark** The display A3 board assembly has an error.
- 7052 A3 Unknown failure** The display A3 board assembly has an error.
- 7053 A3 Subroutine call** The display A3 board assembly had an error related to calling a subroutine.
- 7054 A3 Memory sync** The display A3 board assembly has an error.
- 7055 A3 Serial interface** The display A3 board assembly has a serial interface error.
- 7056 A3 Memory read** The display A3 board assembly has a memory read error.
- 7057 A3 Memory write** The display A3 board assembly has a memory write error.
- 7058 A3 Memory R/W** The display A3 board assembly has a read/write error.
- 7059 A3 Memory Address** The display A3 board assembly was not able to access A4 RAM.
- 7060 A6 RAM data (U37)** The display has a RAM data error in A3U37.
- 7061 A6 RAM data (U38)** The display has a RAM data error in A3U38.
- 7062 A6 RAM address** The display A6 board assembly has a RAM address error.
- 7063 A6 ROM U39 checksum** The display has a ROM checksum error in A6U39.

- 7064 A6 ROM U40 checksum** The display has a ROM checksum error in A6U40.
- 7065 A6 ROM U47 checksum** The display has a ROM checksum error in A6U47.
- 7066 A6 ROM U48 checksum** The display has a ROM checksum error in A6U48.
- 7067 A3 Start vector** The display A3 board assembly has a start vector error.
- 7068 A3 Conditional write** The display A3 board assembly has a conditional write error.
- 7069 A3 Work write** The display A3 board assembly has a work write error.
- 7070 A3 Dot write** The display A3 board assembly has a dot write error.
- 7071 A3 Limit error** The display A3 board assembly has a limit error.
- 7072 A3 Memory arbitration** The display A3 board assembly has a memory arbitration error.

Display-Disruptive Errors

These error messages indicate faulty hardware in a display (e.g., HP 70205A). Display-disruptive errors blank the normal CRT display and present the error message in large block letters. Refer to the appropriate display Technical Reference for more information.

- A3 SERIAL INTERFACE**
- A3 MEMORY READ**
- A3 MEMORY WRITE**
- A3 MEMORY R/W**
- A3 MEMORY ADDRESS**
- A3 CHAR SET**
- A3 RETURN FAILED**
- A3 MARK FAILED**
- A3 ??? FAILED**
- A3 WRONG DATECODE**
- A3 MEMORY SYNC**
- A3 CALL FAILED**
- A3 START VECTOR**
- A3 CHAR SET**
- A3 COND WRITE**
- A3 DOT WRITE**
- A3 WORD WRITE**
- A3 LIMITS ERR**
- A3 MEMORY ARB**

A4 PIXEL RAM

- A6 ROM ____ CHECKSUM** The ____ will be a 39, 40, 47, and/or 48
- A6 RAM ADDRESS ERROR**
- A6 RAM DATA ERROR (U37)**
- A6 RAM DATA ERROR (U38)**
- A6 8041 INTERFACE**

A6 EXCEPTION AT ____ The ____ will be a hex address. This error message will be displayed with one of these additional error messages:

**BUS ERR
ADDR ERR
ILLEGAL
ZERO DIV
CHECK
TRAPV
PRIV VIO
TRACE
I010
1111
RESERVED
UNINIT
SPURIOUS**

REPLACEABLE SYSTEM PARTS

This section contains ordering information and the following system-level replaceable-parts tables:

- Table 5-2. Cabinet Interconnect and Rack-Mount Kits
- Table 5-3. Firmware Upgrade Kits
- Table 5-4. Interconnection Cables and Adapters
- Table 5-5. Miscellaneous System-Level Parts
- Table 5-6. Service Accessories

Instructions for returning a faulty instrument to Hewlett-Packard for repair are given in the Packaging section of Chapter 1. For more information about troubleshooting, repair, and lower-level parts, refer to the appropriate Technical Reference for the mainframe or element.

ORDERING INFORMATION

To order a part that is listed in the replaceable parts list, contact the nearest Hewlett-Packard office and give the following information:

1. Hewlett-Packard part number of each part required
2. Check digit (CD) of each part (if known)
3. Quantity required
4. Name and address for delivery and billing

To order a part that is **not** listed in the replaceable parts list, contact the nearest Hewlett-Packard office and give the following information:

1. Model number of element or mainframe that needs replacement part (e.g., HP 70904A RF Section)
2. Serial number of element or mainframe
3. Description and function of each part required
4. Quantity required
5. Name and address for delivery and billing

DIRECT MAIL-ORDER SYSTEM

Within the USA, Hewlett-Packard can supply parts through a direct mail-order system. The advantages of using this system are listed below.

1. Direct ordering and shipment from the HP Parts Center in Mountain View, California
2. No maximum or minimum on any mail order (There is, however, a minimum order amount for parts ordered through a local HP office when the orders require billing and invoicing.)
3. Prepaid transportation (There is a small handling charge for each order.)
4. No invoices (A check or money order must accompany each order.)

Mail order forms and specific ordering information are available through your local HP office.

REPLACEABLE PARTS TABLES

Table 5-2. Cabinet Interconnect and Rack-Mounting Kits

HP PART NUMBER	CD	DESCRIPTION
70001-60059	9	Cabinet Interconnect Kit: to connect a mainframe to another mainframe
5061-9061	6	Cabinet Interconnect Kit: to connect a mainframe to a System Graphics Display
5061-9678	7	Rack Flange Kit: to mount w/out handles (Same as Option 908)
5061-9684	9	Rack Flange Kit: to mount with handles (Same as Option 913)
1494-0058	6	Rack-Mount with Slides: to mount mainframe in HP Rack (Same as Option 010)
1494-0059	7	Rack-Mount with Slides: To mount System Graphics Display in HP rack (Same as Option 011)
1494-0064	4	Adapter Kit: for rack-mount with slides in non-HP rack (Use with Option 010, or HP Part Number 1494-0058)
1494-0061	1	Adapter Kit: for rack-mount with slides in non-HP rack (Use with Option 011, or HP Part Number 1494-0059)

Table 5-3. Firmware Upgrade Kits

HP PART NUMBER	CD	DESCRIPTION
70205-60044	8	Upgrade Kit: updated dot generator firmware for a display (HP 70205A or HP 70206A). Allows the HP 70700A Digitizer to use all of its capabilities.
70900-60096	2	Upgrade Kit: updated firmware for an HP 70900A Local Oscillator (LO) with firmware of 860203 or earlier. Allows the HP 70700A Digitizer to work as a slave to the LO.
70900-60105	4	Upgrade Kit: updated firmware for an HP 70900A Local Oscillator (LO) with firmware of 861015. Allows the HP 70700A Digitizer to work as a slave to the LO.

Table 5-4. Interconnection Cables and Accessories

HP PART NUMBER/ITEM	CD	DESCRIPTION
		HP-MSIB Cables
HP 70800A		Cable: HP-MSIB, 0.5 meter
HP 70800B		Cable: HP-MSIB, 1.0 meter
HP 70800C		Cable: HP-MSIB, 2.0 meter
HP 70800D		Cable: HP-MSIB, 6.0 meter
HP 70800E		Cable: HP-MSIB, 30 meter
		HP 70700A Digitizer Cables and Accessories
08753-60061	1	Cable: SMB push-on, 15 cm (6 inch)
5061-1022	3	Cable: SMB push-on, 30 cm (12 inch)
1250-1391	6	Adapter: Tee, SMB, male/female/male
		Miscellaneous System Cables
5061-9038	7	Cable: flexible coax SMA, for inter-module connections
5061-9039	8	Cable: flexible coax SMA, for mainframe-to-mainframe connections

Table 5-5. Miscellaneous System-Level Parts

HP PART NUMBER	CD	DESCRIPTION
5061-9006	7	Panel: front blank 1/8 module size, for use in mainframe
70001-40017	7	Filter: optional air filter, for mainframe
1420-0315	3	Battery: 3.60V 1.7AH, for use in displays
70001-60066	8	Isolation Transformer Assembly: for 400 Hz options

Table 5-6. Service Accessories

HP PART NUMBER	CD	DESCRIPTION
Display Service Accessories		
70206-60029	0	Extender Kit: for servicing displays, includes the following extenders:
70206-60027	8	Extender: for host board assembly
70206-60028	9	Extender: for memory and dot generator board assemblies
70205-60022	2	Extender: 24 pin, for HP 70205A power supply board assembly and HP 70206A sweep board assembly
70206-60041	6	Extender: special, for HP 70206A only
70206-60042	7	Extender: for HP-MSIB
HP 70700A Service Accessories		
70700-60011	9	Service Accessory for Downloading RAM Firmware: contains disc(s) and instructions needed to reload HP 70700A RAM data using an external controller
10871-60002	8	Filter Assembly: 1 MHz, 5 MHz, and 10 MHz low-pass
Miscellaneous System Service Accessories		
70001-60013	5	Module Service Extender
8710-1307	7	8MM Hex-Ball Driver: for removing and installing modules
85680-60093	3	Cable: SMB (F) to BNC (M)
8120-1578	3	Cable: SMA (F) to SMA (M)
1251-2277	1	Adapter: BNC (F) to dual banana (F)
1250-1159	4	Adapter: SMA (M) to SMA (M)

