M9032A/M9033A System Sync Modules

Notices

Copyright Notice

© Keysight Technologies 2023

No part of this manual may be reproduced in any form or by any means (including electronic storage and retrieval or translation into a foreign language) without prior agreement and written consent from Keysight Technologies as governed by United States and international copyright laws.

Trademarks

UNIX is a registered trademark of UNIX System Laboratories in the U.S.A. and other countries. Target is copyrighted by Thru-Put Systems, Inc.

Manual Part Number

M903x-91003

Edition

1.1, May 2023

Available in electronic format only

Published by

Keysight Technologies, Inc.
1900 Garden of the Gods Road
Colorado Springs, CO 80907 USA

Technology Licenses

The hardware and/or software described in this document are furnished under a license and may be used or copied only in accordance with the terms of such license.

Declaration of Conformity

Declarations of Conformity for this product and for other Keysight products may be downloaded from the Web. Go to <http://www.keysight.com/go/conformity> and click on "Declarations of Conformity." You can then search by product number to find the latest Declaration of Conformity.

U.S. Government Rights

The Software is "commercial computer software," as defined by Federal Acquisition Regulation ("FAR") 2.101. Pursuant to FAR 12.212 and 27.405-3 and Department of Defense FAR Supplement ("DFARS")

227.7202, the U.S. government acquires commercial computer software under the same terms by which the software is customarily provided to the public. Accordingly, Keysight provides the Software to U.S. government customers under its standard commercial license, which is embodied in its End User License Agreement (EULA), a copy of which can be found at <http://www.keysight.com/find/sweula>. The license set forth in the EULA represents the exclusive authority by which the U.S. government may use, modify, distribute, or disclose the Software. The EULA and the license set forth therein, does not require or permit, among other things, that Keysight: (1) Furnish technical information related to commercial computer software or commercial computer software documentation that is not customarily provided to the public; or (2) Relinquish to, or otherwise provide, the government rights in excess of these rights customarily provided to the public to use, modify, reproduce, release, perform, display, or disclose commercial computer software or commercial computer software documentation. No additional government requirements beyond those set forth in the EULA shall apply, except to the extent that those terms, rights, or licenses are explicitly required from all providers of commercial computer software pursuant to the FAR and the DFARS and are set forth specifically in writing elsewhere in the EULA. Keysight shall be under no obligation to update, revise or otherwise modify the Software. With respect to any technical data as defined by FAR 2.101, pursuant to FAR 12.211 and 27.404.2 and DFARS 227.7102, the U.S. government acquires no greater than Limited Rights as defined in FAR 27.401 or DFAR 227.7103-5 (c), as applicable in any technical data.

Warranty

THE MATERIAL CONTAINED IN THIS DOCUMENT IS PROVIDED "AS IS," AND IS SUBJECT TO BEING CHANGED, WITHOUT NOTICE, IN FUTURE EDITIONS. FURTHER, TO THE MAXIMUM EXTENT PERMITTED BY APPLICABLE LAW, KEYSIGHT DISCLAIMS ALL WARRANTIES, EITHER EXPRESS OR IMPLIED WITH REGARD TO THIS MANUAL AND ANY INFORMATION CONTAINED HEREIN, INCLUDING BUT NOT LIMITED TO THE IMPLIED WARRANTIES OF MERCHANT-

ABILITY AND FITNESS FOR A PARTICULAR PURPOSE. KEYSIGHT SHALL NOT BE LIABLE FOR ERRORS OR FOR INCIDENTAL OR CONSEQUENTIAL DAMAGES IN CONNECTION WITH THE FURNISHING, USE, OR PERFORMANCE OF THIS DOCUMENT OR ANY INFORMATION CONTAINED HEREIN. SHOULD KEYSIGHT AND THE USER HAVE A SEPARATE WRITTEN AGREEMENT WITH WARRANTY TERMS COVERING THE MATERIAL IN THIS DOCUMENT THAT CONFLICT WITH THESE TERMS, THE WARRANTY TERMS IN THE SEPARATE AGREEMENT WILL CONTROL.

Safety Information

CAUTION

A CAUTION notice denotes a hazard. It calls attention to an operating procedure, practice, or the like that, if not correctly performed or adhered to, could result in damage to the product or loss of important data. Do not proceed beyond a CAUTION notice until the indicated conditions are fully understood and met.

WARNING

A WARNING notice denotes a hazard. It calls attention to an operating procedure, practice, or the like that, if not correctly performed or adhered to, could result in personal injury or death. Do not proceed beyond a WARNING notice until the indicated conditions are fully understood and met.

Safety Summary

The following general safety precautions must be observed during all phases of operation of this instrument. Failure to comply with these precautions or with specific warnings or operating instructions in the product manuals violates safety standards of design, manufacture, and intended use of the instrument. Keysight Technologies assumes no liability for the customer's failure to comply with these requirements. Product manuals are provided on the Web. Go to www.keysight.com and type in your product number in the Search field at the top of the page.

WARNING

Do not use the device if it is damaged. Contact your Keysight sales representative for replacement of device.

WARNING

Verify that all safety precautions are taken. Make all connections to the unit before applying power. Note the external markings described under “Safety symbols & instrument markings”.

WARNING

Do not operate the device in an explosive atmosphere or wet environments. Do not operate the instrument around flammable gases or fumes, vapor, or wet environments.

WARNING

Do not install substitute parts or perform any unauthorized modification to the product. Return the product to a Keysight Sales and Service Office to ensure that safety features are maintained.

CAUTION

If the device is used in a manner not specified by the manufacturer, the protection provided by the device may be impaired.

CAUTION

Do not attempt to clean the device. If cleaning the card is absolutely necessary, Keysight recommends cleaning the card with a lightly dampened cloth while the module is in a de-energized condition. Do not re-energize the card until it is completely dry.

NOTE

The safety of any system incorporating the equipment is the responsibility of the assembler of the system.

WARNING

If this product is not used as specified, the protection provided by the equipment could be impaired. This product must be used in a normal condition (in which all means for protection are intact) only.

CAUTION

The measuring terminals on this instrument are designed to be used with external signals described in Mains-isolated secondary circuits, but NOT with external signals described in Categories II, III, and IV. The input of this instrument cannot be connected to the mains.

Measurement Category	Description
II	Applicable to testing and measuring circuits connected directly to utilization points (socket outlets and similar points) of the low-voltage mains installation. Example: Measurements on MAINS CIRCUITS of household appliances, portable tools and similar equipment and on the consumer side only of socket-outlets in the fixed installation.
III	Applicable to test and measuring circuits connection to the distribution part of the building's low-voltage mains installation. To avoid risks caused by the hazards arising from these higher short-circuit currents, additional insulation and other provisions are required. Example: Measurements on distribution boards (including secondary meters), photovoltaic panels, circuit breakers, wiring, including cables, bus-bars, junction boxes, switches, socket-outlets in the fixed installation, equipment for industrial use and some other equipment such as stationary motors with permanent connection to the fixed installation. NOTE: For equipment that is part of a fixed installation, the fuse or circuit breaker of the installation can be considered to provide adequate protection against short-circuit currents.
IV	Applicable to test and measuring circuits connected at the source of the building's low-voltage mains installation. Due to these high short-circuit currents, which can be followed by a high energy level, measurements made within these locations are extremely dangerous. Great precautions shall be made to avoid any chance of a short circuit. Example: Measurements on devices installed before the main fuse or circuit breaker in the building installation.

WARNING

To ensure mandatory safety requirements are being met, the module must be installed in a chassis which has been certified and marked by a Nationally Recognized Testing Lab (such as CSA, UL, TUV, ETL, and so on) in which all the means of protection are properly implemented. Note that CE marking alone is not adequate.

WARNING

Servicing of the modules must be performed by qualified personnel only. To avoid electrical shock, do not perform any servicing manually. Return the module to Keysight Service Center.

WARNING

For safety reasons, only Keysight approved equipment and accessories should be used with the module.

NOTE

Position chassis to ensure easy access to remove the modules.

Environmental
Conditions

This instrument is intended for “indoor use” only.

The following table shows the environmental requirements and the corresponding characteristics for the product.

NOTE







The modules default to the environmental ratings of the chassis where they are inserted, if the ratings of the chassis are lower.

Environmental Requirements	General Characteristics
Temperature	Operating condition: 0°C to 45°C Storage condition: -40°C to 70°C
Maximum Relative Humidity (non-condensing)	Type tested, 95% RH up to 40°C, decreases linearly to 40% RH at 45°C
Altitude	Operating condition: Up to 10,000 ft (3048m) Storage condition: Up to 15,000 ft (4572m)
Pollution degree*	Pollution Degree 2

* See table below for Pollution Degree definitions

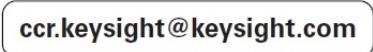

Pollution Degree	Description
1	No pollution or only dry, non-conductive pollution occurs. The pollution has no influence. Example: A clean room or climate-controlled office environment.
2	Normally only dry non-conductive pollution occurs. Occasionally a temporary conductivity caused by condensation may occur. Example: General indoor environment.
3	Conductive pollution occurs, or dry, non-conductive pollution occurs which becomes conductive due to condensation which is expected. Example: Sheltered outdoor environment.

Safety symbols & instrument markings

Safety Symbol / Instrument Marking	Description
	<p>The instruction manual symbol. The product is marked with this warning symbol when it is necessary for the user to refer to the instructions in the manual.</p>
	<p>The CE mark is a registered trademark of the European Community.</p>
	<p>The UK mark is a registered trademark of the European Community.</p>
	<p>The RCM mark is a registered trademark of the Australian Communications and Media Authority.</p>
	<p>The KC mark is the Korean certification mark. This equipment is Class A suitable for professional use and is for use in electromagnetic environments outside of the home.</p>
	<p>Electro Static Discharge. Attach ESD protective wrist strap to avoid damage by direct contact with the equipment.</p>
	<p>China Restricted Substance Product Label. The EPUP (environmental protection use period) number in the center indicates the time period during which no hazardous or toxic substances or elements are expected to leak or deteriorate during normal use and generally reflects the expected useful life of the product.</p>
	<p>This is the Keysight email address required by EU directives applicable to our product.</p>

Compliance and Environmental Information

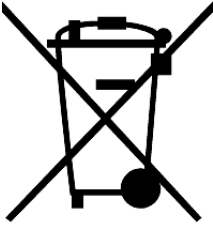
Table 1 Compliance and Environmental Information

Safety Symbol	Description
 	<p>The crossed out wheeled bin symbol indicates that separate collection for waste electric and electronic equipment (WEEE) is required, as obligated by DIRECTIVE 2012/19/EU and other National legislation.</p> <p>Refer to http://about.keysight.com/en/companyinfo/environment/takeback.shtml to understand your Trade in options with Keysight in addition to product take-back instructions.</p>

Declaration of Conformity

Declarations of Conformity for this product and for the Keysight products may be downloaded from the Web. Go to <http://www.keysight.com/go/conformity>.

You can then search by product number to find the latest Declaration of Conformity.

Contents

Safety Summary	3
Safety symbols & instrument markings	6
Compliance and Environmental Information	7
Declaration of Conformity	7

1 Overview on M9032A / M9033A System Sync Modules

About this document	12
About M9032A / M9033A System Sync Modules	13
Equipment supported with M903xA modules	19
References to Help documents	20

2 Setting up the M9032A / M9033A modules

Unpacking, Inspecting and Verifying the shipment	22
Precautions against ESD	22
Verifying shipment of M9032A / M9033A module	23
Inspecting for damage	24
Returning the Module for Service	24
Installing the PXIe Module	26
Before Installing the Module	26
Preparing the PXIe Chassis	28
Installing the Embedded Controller	29
Connecting a remote controller PC to the chassis	31
Installing Slot Blockers and Filler Panels	32
Installing the Module	33
Powering up the Chassis and Remote Controller PC	34
Installing required software	35

Verifying M903xA module's operation	36
Verifying M9032A / M9033A connections	36
Conducting Self test	38
Cleaning the module	41

3 Setting up the M9032x software

Prerequisites to setting up M9032x software	44
System requirements	44
Prerequisite software requirements	44
Downloading and installing M9032x software	45
Downloading the M9032x software	45
Installing the M9032x software	45
Installing M9032A / M9033A module firmware updates	49
Launching the software	51
Launching the M9032x user interface	51
Programming with M9032x API	56

4 Troubleshooting and Safety information

Troubleshooting installation issues	58
Safety information	59
General safety considerations	59

M9032A / M9033A System Sync Modules

Startup Guide

1. Overview on M9032A / M9033A System Sync Modules

[About this document](#) / 12

[About M9032A / M9033A System Sync Modules](#) / 13

[References to Help documents](#) / 20

Section 1.1: About this document

This document helps you get started with a brief introduction to the M9032A / M9033A System Sync modules along with its associated software components. It also serves as a guide for the required preliminary setup followed by procedures to install the Keysight M9032x/M9033x System Synchronization Module SFP and API along with its extended components.

Section 1.2: About M9032A / M9033A System Sync Modules

The M9032A/M9033A PXIe System Synchronization Module (SSM) provides multi-module/multi-chassis synchronization and triggering for Keysight's modular systems, as well as other Keysight instruments. It meets the STM specifications documented in the PXI Express Hardware Specification.

The M9032A is a single width and the M9033A is a double width 3U PXIe module that is compatible with Keysight's PXIe chassis. It includes a high-quality Oven Controlled Crystal Oscillator (OCXO) reference clock, flexible signal connections between front panel and backplane trigger resources, and accurate phase measurement capability on select clock paths, in order to achieve a very tight synchronization among various measurement products.

The M9032A/M9033A modules use the newly defined System Sync standard to distribute reference clock, low-latency LVDS triggers, and high bandwidth/speed information through Multi-Gigabit Transceiver (MGT) links across multiple instruments. The System Sync connector provides a forward and reverse clock link to facilitate cable delay measurement and compensation, up to 12 LVDS pairs for low latency trigger or data transition, and another 4 MGT pairs (TX and RX) for higher bandwidth data transfer, up to 5 Gbps.

These modules can also support time synchronization to common time standards delivered through various Options, such as GPS, IRIG, or IEEE1588 (which shall be available in future releases). These options enable these modules to synchronize measurement systems to actual Time of Day marks, allowing for precisely time-stamped measurement data from spatially dispersed equipment to be correlated.

The M9032A/M9033A modules include a Virtex Ultrascale Plus FPGA to support enhanced features associated with PathWave FPGA and HVI technology in the future releases.

Figure 1 and **Figure 2** shows the front view of a M9032A/M9033A PXIe System Synchronization Module.



Figure 1 Front view of the M9032A single width 3U PXIe module

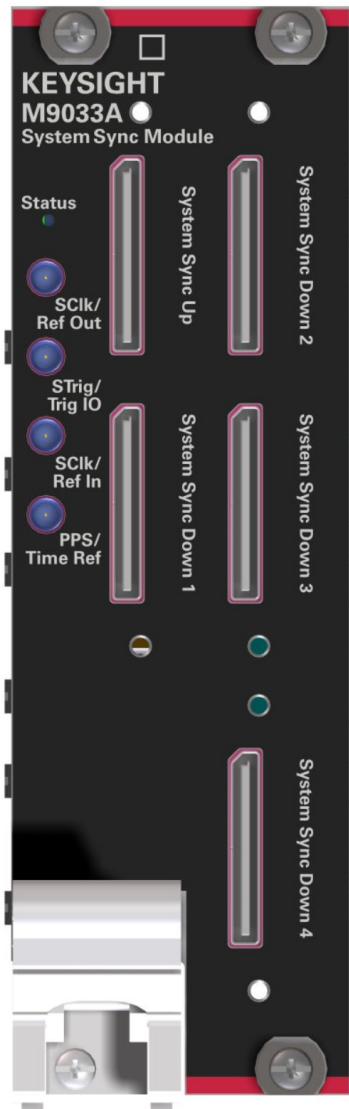

Figure 2 Front view of the M9033A double width 3U PXIe module

Table 2 lists the hardware specifications of the M9032A / M9033A modules.

Table 2 M9032A / M9033A module specifications

Hardware attributes	M9032A (Single-Slot Module)	M9033A (Dual-Slot Module)
Front panel connectors	Four SMP male, 50 Ω	Four SMP male, 50 Ω
	Two Oculink, 85 Ω	Five Oculink, 85 Ω
Front panel indicators	1 tricolor LED (red, green, blue)	1 tricolor LED (red, green, blue)
Dimensions	3U/1-Slot PXI/CompactPCI Standard	3U/2-Slot PXI/CompactPCI Standard
Weight	0.45 kg (1.0 lbs)	0.74 kg (1.6 lbs)

The M9032A and M9033A System Sync Module front panel contains various connectors that can be used for both multi-chassis interconnection and configuration of the reference signal source.

Table 3 describes the FP (Front Panel) SMP (Sub Miniature Push-on) connectors labeled in Figure 1 and Figure 2.

Table 3 M9032A / M9033A connectors and their description

Label	Description
SCLK/Ref Out	Outputs a copy of the system clock or a timebase reference clock signal with a frequency of 10 or 100 MHz.
STrig/Trig IO	Receive an arbitrary trigger signal with a frequency between DC and 10MHz.
SCLK/Ref In	Receives the system clock or a timebase reference clock signal with a frequency of 10 or 100 MHz.
PPS/Time Ref	Receives a Pulse Per Second (PPS) signal.

The front panel SMP connectors can be used to share input and output timebase reference clocks.

CAUTION

Exercise caution and ensure proper alignment when connecting / removing the straight / right-angle cable assembly to the SMP connectors to prevent any damage to the center pin on these connectors. After aligning properly, press the cable head very gently into the connector. **DO NOT** push hard the cable into the SMP connector.

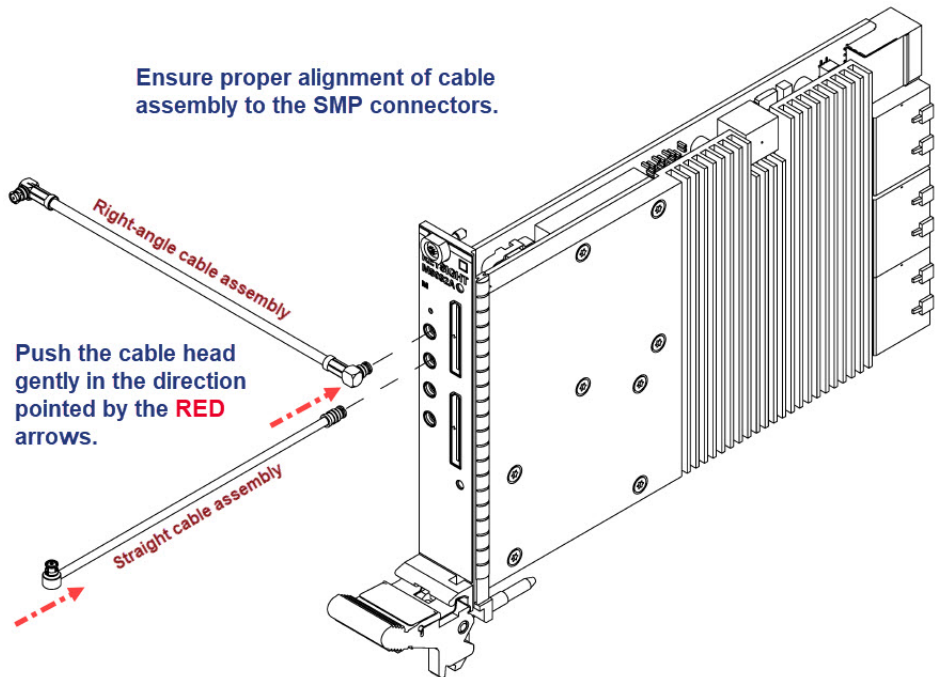

Figure 3 Aligning and connecting SMP cable assembly to M9032A front panel

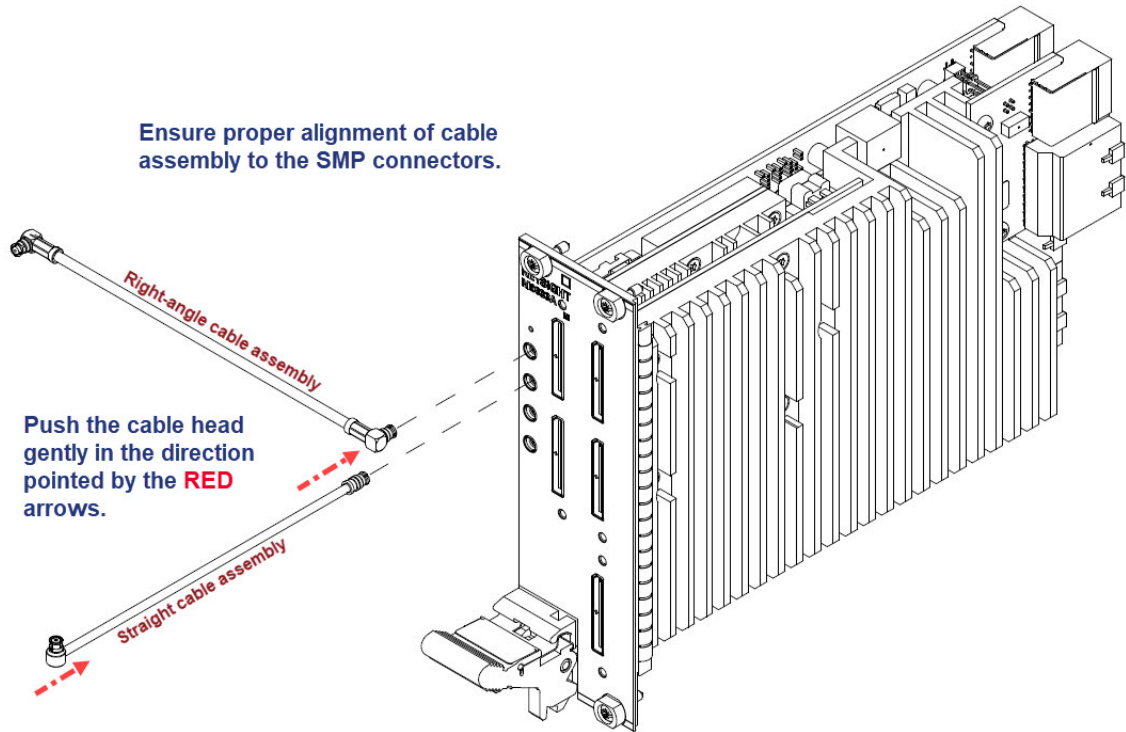

Figure 4 Aligning and connecting SMP cable assembly to M9033A front panel

The different SSM models have the following front panel System Sync ports:

- The M9032A has two System Sync ports:
 - 1 System Sync Upstream
 - 1 System Sync Downstream
- The M9033A has five System Sync ports:
 - 1 System Sync Upstream
 - 4 System Sync Downstream

All System Sync ports use PCIe OcuLink [Optical Copper (Cu) Link] connectors. System Sync ports can be used for chassis interconnection and synchronization in the multi-chassis system. The next section details how the signals shared over System Sync connections can be shared for such purposes. Each System Sync Downstream port can connect to the System Sync Upstream port of another System Sync Module (placed in a

different chassis) or to up to two System Link ports placed on PXIe modules. Keysight System Sync and/or System Link cables can be used for such connections.

1.2.1: Equipment supported with M903xA modules

Table 4 List of supported equipment

Required equipment	Quantity	Recommended Part number(s)
PXI Chassis	1 (choose one model)	Contact Keysight Support for more information on the Chassis to procure or refer to the PXIe Chassis and Controllers webpage for more information. <ul style="list-style-type: none"> ▪ M9032A (Single-Slot Module) requires one 3U PXI Express slot (System Timing slot) chassis ▪ M9033A (Dual-Slot Module) requires two 3U PXI Express slot (System Timing Slot + subsequent slot) chassis
PXIe Embedded Controller	1	M9037A
Breakout Board for IO	1	-

CAUTION

*Use caution when mating high-density connectors to ensure proper alignment and to prevent damage to the contacts.

Section 1.3: References to Help documents

Table 5 Reference document titles and access links

Document Reference	Filename / Format	Reference location
M9032A / M9033A System Sync Modules Startup Guide	PDF	
M9032A / M9033A System Sync Modules Security Guide	PDF	https://www.keysight.com/find/M903xA-TechSupport
M9032A / M9033A System Sync Modules User's Guide (including SFP Help)	PDF	
M9032A / M9033A System Sync Modules Data Sheet	PDF	

2. Setting up the M9032A / M9033A modules

Unpacking, Inspecting and Verifying the shipment / 22

Installing the PXIe Module / 26

Verifying M903xA module's operation / 36

Cleaning the module / 41

Section 2.1: Unpacking, Inspecting and Verifying the shipment

The module arrives packed in one small box. Before unpacking your module(s), inspect the packaging container for evidence of mishandling during transit. Inspect the carton carefully for any damage, or signs of rough handling.

Remove the M9032A / M9033A module from the packaging container and ensure that all accessories are included. Inspect the module and accessories for damage. If the contents appear damaged, notify your local Keysight Technologies Inc. representative.

CAUTION

The module is shipped in materials which prevent damage from static. The module should only be removed from the packaging in an anti-static area ensuring that correct anti-static precautions are taken. Store the module in an anti-static envelope when not in use.

2.1.1: Precautions against ESD

Electrostatic discharge (ESD) can damage or destroy electronic components. Use a static-safe workstation to perform all work on electronic assemblies. Figure 5 shows a static-safe workstation using two types of ESD protection:

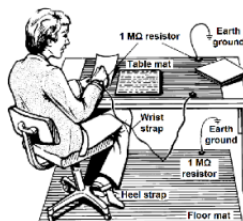

Figure 5 Static-safe workstation for ESD protection

- Conductive table-mat and wrist-strap combination
- Conductive floor-mat and heel-strap combination

Both types, when used together, provide a significant level of ESD protection. Of the two, only the table-mat and wrist-strap combination provides adequate ESD protection when used alone. To ensure user safety, the static-safe accessories must provide at least 1 M Ω of isolation from ground.

WARNING

DO NOT use these techniques for a static-safe workstation when working on circuitry with a voltage potential greater than 500 volts.

2.1.2: Verifying shipment of M9032A / M9033A module

Table 6 and Table 7 lists the items included in your M9032A / M9033A module shipment:

Table 6 Verifying M9032A module shipment items

Qty.	Keysight Part number	Description
1	M9032A	Keysight M9032A PXIe System Synchronization Module (one-slot)
1	M9032-92000	Keysight M9032A PXIe System Synchronization Module Quick Start Guide
1	5972-3335	PXI Modular Product Startup Quick Reference
1	9320-6715	China RoHS Addendum for Modules
1	9320-6797	Keysight safety leaflet

Table 7 Verifying M9033A module shipment items

Qty.	Keysight Part number	Description
1	M9033A	Keysight M9033A PXIe System Synchronization Module (dual-slot)
1	M9033-92000	Keysight M9033A PXIe System Synchronization Module Quick Start Guide
1	5972-3335	PXI Modular Product Startup Quick Reference
1	9320-6715	China RoHS Addendum for Modules
1	9320-6797	Keysight safety leaflet

2.1.3: Inspecting for damage

After unpacking an instrument, inspect it for any shipping damage. Report any damage to the shipping agent immediately, as such damage is not covered by the warranty (Refer to the warranty information at beginning of this document).

CAUTION

To avoid damage when handling the M9032A / M9033A modules, do not touch exposed connector pins.

Visit www.keysight.com/find/tips for information on preventing damage to your Keysight equipment.

2.1.4: Returning the Module for Service

If you find it necessary to return the M9032A / M9033A modules for repair or service, follow the steps below:

NOTE

The M9032A / M9033A modules are factory tested, aligned, adjusted, and each module is shipped as a single unit.

- 1 Review the warranty information shipped with your M9032A / M9033A modules.
- 2 Contact Keysight to obtain a Return Material Authorization (RMA) and return address. For assistance with finding the required contact information, visit www.keysight.com/find/assist.
- 3 Write the following information on a tag and attach it to the malfunctioning equipment:
 - Name and address of owner. A P.O. box is not acceptable as a return address.
 - Description of failure or service required.
- 4 Pack the instrument in its original packaging. Include all cables. If the original packaging material is not available, use anti-static bubble wrap or packing peanuts. Place the instrument in a sealed container and mark the container "FRAGILE".
- 5 On the shipping label, write ATTENTION REPAIR DEPARTMENT and the RMA number.
- 6 In your correspondence, refer to the module by serial number.

Section 2.2: Installing the PXIe Module

Proceed through this section in the following order:

- 1 Review before installing the Module to understand installation guidelines and precautions.
- 2 Prepare the PXIe Chassis for the installation process.
- 3 Install the Controller (embedded or external).
- 4 Install the PXIe Module.
- 5 Install slot blockers and filler panels in the empty PXIe chassis slots.
- 6 Power up the PXIe chassis.

For more information about the appropriate configuration of your single chassis and multi-chassis systems, visit www.keysight.com/find/pxie-multichassis.

2.2.1: Before Installing the Module

CAUTION

PXIe hardware does not support “hot-swap” (changing modules while power is applied to the chassis) capabilities. Before installing or removing a module to/from the chassis, power down the chassis to prevent damage to the module.

Best practices for cooling chassis & M9032A/M9033A modules

The following are the recommended best practices to ensure proper and safe module operating conditions:

- Ensure that the ambient air temperature around the chassis does not exceed 45°C.
- To maintain proper airflow within the chassis, all empty chassis slots must be fitted with slot blockers (Keysight model [Y1212A](#), 5 per kit) and EMC filler panels (Keysight model [Y1213A](#), 5 per kit). This includes any empty slots to the left of slot 1.
- Ensure that adequate clearance is provided around all chassis vents, both air intake vents, and air exhaust vents, including any vents at the bottom of the chassis. For more information, refer to the documentation associated with the Chassis you are using.
- Ensure that all the fan filters are clean and unobstructed.

- To the extent possible, install the chassis in a location with lower ambient temperatures. For example, avoid the situation where the exhaust air from another chassis feeds into the air intake for this chassis.
- If you have multiple M9032A / M9033A modules and space is available in your chassis, leave an empty slot between modules to enhance airflow. Ensure that a slot blocker and a filler panel are installed in the empty slots. Be aware that leaving an empty slot between modules changes the length of inter-module cables, if any, and may also cause the modules to be on different chassis backplane PXI_TRIG trigger bus segments.
- Set the fan speed switch on the rear panel of the chassis to **HIGH**. If this switch is set to **AUTO**, the module may not receive sufficient airflow to provide adequate cooling. This can result in a thermal shutdown of the M9032A / M9033A module. Note that some chassis, when the fan speed switch is set to **AUTO**, ramp up the fan speed if excess heat is detected within the chassis. However, all chassis do not exhibit this behavior; so setting the fan speed switch to **HIGH** ensures maximum cooling with all chassis.

The Keysight Chassis have multiple air intakes. They are located at the lower sides, lower front and bottom of the chassis.



Figure 6 Depiction of air flow in the M9018A chassis

2.2.2: Preparing the PXIe Chassis

- 1 Make sure that the line cord is plugged into a grounded outlet to establish earth ground.

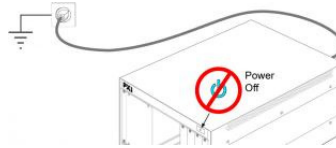

Figure 7 Establishing earth ground to the chassis

- 2 Make sure that the chassis power switch is **Off**.
- 3 Before inserting a module into the chassis, back the mounting screws out to ensure that there is no interference between the screws and the mounting rails.
- 4 Make sure that the PXIe chassis fans are operable and free of dust and other contaminants that may restrict airflow.

2.2.3: Installing the Embedded Controller

Before installing the module, remove plastic thread protectors on the top and bottom of mounting screws. Use the appropriate instructions below for installing the embedded controller or the **remote controller**.

CAUTION

Do not power up the controller until instructed to do so later in this document.



Figure 8 Front panel view of M9037A Embedded Controller

If your configuration contains a Keysight Embedded Controller (for example, M9037A), follow the procedure below. For additional details, refer to the instructions in the [M9037A Startup Guide](#).

- 1 Remove the M9037A module from its ESD protective bag. See [“Precautions against ESD”](#) on page 22.
- 2 Install the embedded controller in Slot 1 (see the **▲** icon above the slot) in the chassis.

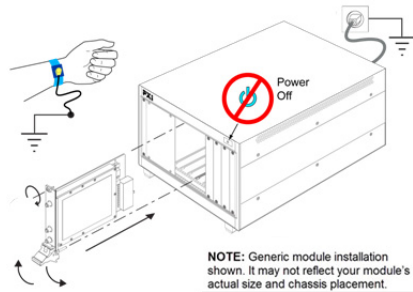

Figure 9 Depiction of installing a PXle embedded controller

- While holding the module by the injector/ejector handle and making sure the injector/ejector handle is pushed down in the unlatched (downward) position, slide the controller module into chassis, using the slot guides (top and bottom).
 - Sliding the module into position, when you begin to feel resistance, pull up on the injector/ejector handle to fully inject the module into the chassis backplane connectors.
 - Tighten the module retaining screws (top and bottom) and torque them to 5 Lb-In (0.57 N-m).
- 3 Install a blank Y1213A filler panel in the empty slot to the left of the controller.
 - 4 Connect peripherals (mouse, keyboard, and monitor).

2.2.4: Connecting a remote controller PC to the chassis

A remote controller is an external, Windows-based PC that connects to the chassis through a PCIe cable. The remote controller can be a desktop PC, a laptop PC, or a rack-mounted PC. If your configuration contains a Keysight Cable Interface module, follow the procedure below.

NOTE

The following procedure addresses using a cabled PCIe interface between the chassis and an external host computer. However, if you intend to use a system module to control a subordinate downstream chassis or RAID configuration:

1. Install the module in an x8 hybrid slot in the PXIe chassis.
2. Reverse the switch settings from those noted in this procedure: On the module, set both the S301 switches to “Host” and set the S201 rocker switch to the left-hand position. On the chassis backplane, set the controller slot power-supply switch to the left.

-
- 1 Locate slot 1 in the chassis, with the ▲ icon above the slot.
 - 2 Set the chassis controller slot power supply switch to the right-hand position. This provides power to slot 1 for the benefit of the PCIe interface card.
 - 3 Remove the interface module from its protect bag. See “[Precautions against ESD](#)” on page 22.
 - 4 On the module, set both S301 switches to the Host (right-hand) position and set the S201 rocker switch to the left-hand position.
 - 5 Install the Cable Interface module into the chassis:
 - While holding the module by the injector/ejector handle and making sure the injector/ejector handle is pushed down in the unlatched (downward) position, slide the module into chassis, using the slot guides (top and bottom).
 - Sliding the module into position, when you begin to feel resistance, pull up on the injector/ejector handle to fully inject the module into the chassis backplane connectors.
 - Tighten the module retaining screws (top and bottom) and torque them to 5 Lb-In (0.57 N-m).

- 6 Connect the Interface module to your laptop or desktop PC.
 - If you are using a laptop as a controller, connect to your module using the following components:

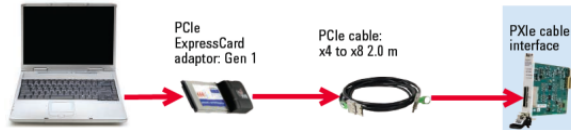

Figure 10 Connecting interface module to laptop

- If you are using a desktop PC as a controller, connect to your module using the following components:

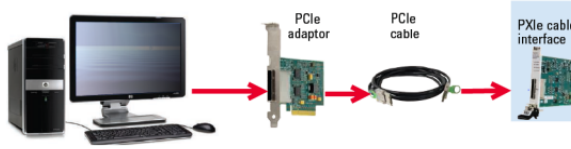

Figure 11 Connecting interface module to desktop PC

2.2.5: Installing Slot Blockers and Filler Panels

To assure proper operating temperatures, install slot blockers (Keysight model **Y1212A**, 5 per kit) and EMC filler panels (Keysight model **Y1213A**, 5 per kit) in empty module slots.

2.2.6: Installing the Module

Plan your module position. Before installing the module, remove plastic thread protectors on the top and bottom of mounting screws. Install the left-most module first and continue installing modules from left to right according to [Figure 12](#).

When installing the M9032A / M9033A module:

- 1 Hold the module by the injector/ejector handle and make sure that the injector/ejector handle is pushed down in the unlatched (downward) position. Slide the module into chassis, using the slot guides (top and bottom).
- 2 Slide the module into position. When you begin to feel resistance, pull up the injector/ejector handle to fully inject the module into the chassis backplane connectors.
- 3 Tighten the module retaining screws (top and bottom) and torque them to 5 Lb-In (0.57 N-m).

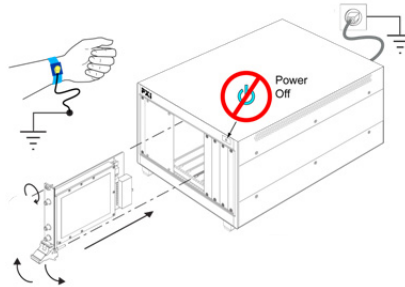

Figure 12 Depiction of installing a PXIe module

NOTE

The image above shows generic module installation. It may not reflect your module's actual size and chassis placement.

CAUTION

As mentioned earlier, exercise caution when attaching / detaching the straight / right-angle cable assembly to the SMP connectors on the front panel of the M9032A/ M9033A modules.

2.2.7: Powering up the Chassis and Remote Controller PC

When powering up the system, the chassis should be powered up first. After powering up the chassis, you should wait at least three seconds before powering on the PC. The chassis front panel temperature LED, which is on for three seconds after the chassis is powered up, provides a convenient way to measure this delay.

- 1 Make sure that the line cord is plugged into a grounded outlet to establish earth ground.

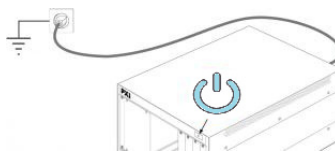

Figure 13 Establishing earth ground to the chassis

- 2 Make sure all cable connections are secure and modules/controller inserted properly.
- 3 Press the power button on the chassis.

CAUTION

If you are using a remote controller and you have installed the interface cable, you must power up the chassis before you power up the PC. When you power down your chassis, shut down the PC before you power down the chassis.

The temperature LED, which is on for the first three seconds after the chassis is powered up, can be used as an indicator of when to power on the PC. When the LED goes off, the PC can be powered on.

- 4 Power on the PC.

CAUTION

PXle hardware does not support “hot-swap” (changing modules while power is applied to the chassis) capabilities. Before installing or removing a module to/from the chassis, power down the chassis to prevent damage to the module.

The PC should be shut down before the chassis is powered down. This will prevent the chassis, as it's being powered down, from disrupting operation of the PC.

In brief, the PC should be off whenever the chassis is powered up or down. Because chassis modules are not hot-swappable, chassis modules should only be added or removed when the chassis is powered down. The power sequence described above doesn't apply to an embedded controller installed in the chassis because the embedded controller and chassis are powered together.

2.2.8: Installing required software

After the PC boots up and Windows desktop appears, you must install the software required for programming the M9032A / M9033A System Sync modules. See [Chapter 3](#), "Setting up the M9032x software".

Section 2.3: Verifying M903xA module's operation

The operation of the M9032A / M9033A System Sync modules must be verified after you ensure that all required software is installed, the chassis is powered on, and all cabling is correct.

2.3.1: Verifying M9032A / M9033A connections

The Keysight Connection Expert (installed with IO Libraries Suite) helps you check the connection of the M9032A / M9033A System Sync modules. To check if the module and its slot location are visible in the Keysight Connection Expert, click **Start > Keysight Connection Expert**.

As shown in [Figure 14](#), the connected instruments are visible in the Connection Expert, including one or more M9032A / M9033A System Sync modules in their respective slots.

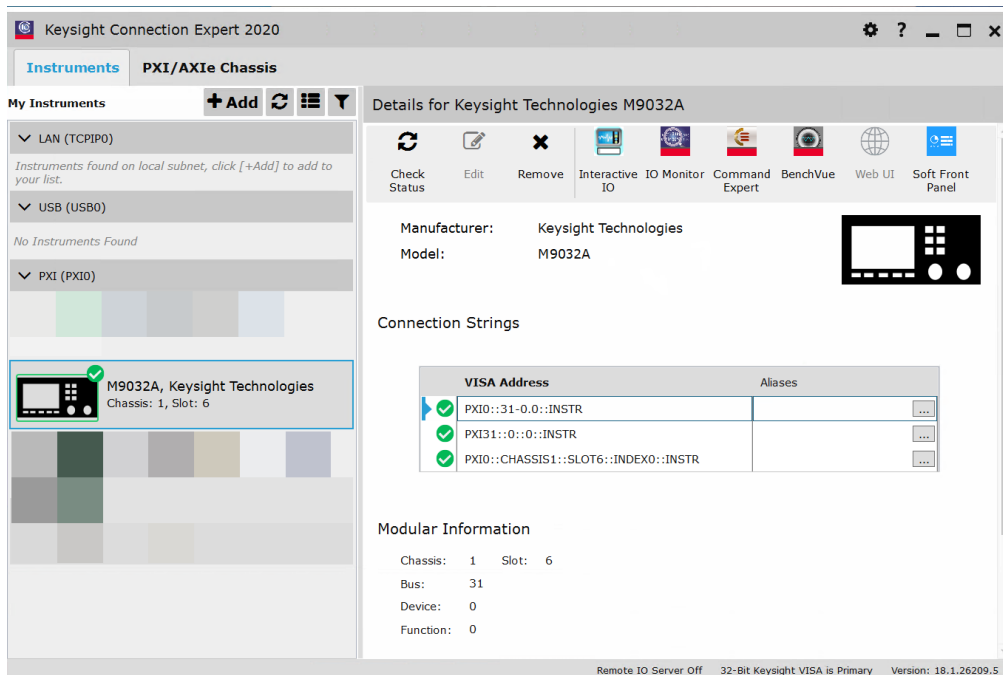



Figure 14 Example - Checking M9032A module connection in Connection Expert

If any or all modules and their slot locations are still not visible in Connection Expert, click the  icon to scan.

You may also launch the M9032x Soft Front Panel (SFP) software to check the M9032A / M9033A modules connection status.

Click **Start > Keysight M9032x PCIe Module > M9032x SFP (x64)**.

The “Connect to Instrument” window appears by default and if connected, it displays the M9032A / M9033A modules along with the respective slots and VISA address.

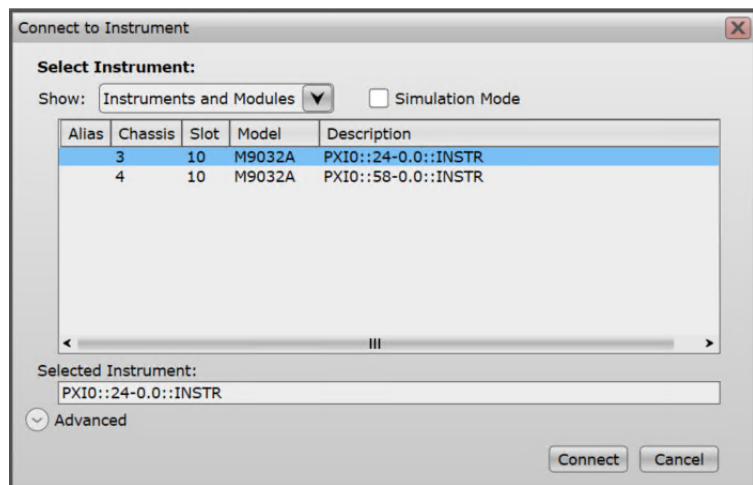

Figure 15 Checking M9032A connection in M9032x SFP

If you are still unable to communicate with the M9032A / M9033A modules, verify that the following software and hardware has been correctly installed:

- Keysight IO Libraries Suite
- M9032x SFP (x64)
- Module and chassis drivers
- System Interface Card, cable and PC PCIe card connections, if you are using an external host PC

For further support, contact a technical support executive at Keysight. Visit <https://www.keysight.com/find/support>.

2.3.2: Conducting Self test

The next step in this process is to conduct a Self Test of the M9032A / M9033A modules.

- 1 Click **Start** > **Keysight M9032x PCIe Module** > **M9032x SFP (x64)** to launch the M9032x SFP.
- 2 On the **Connect to Instrument** window that appears, select the M9032A / M9033A modules you wish to run the self test on, and click **Connect**.

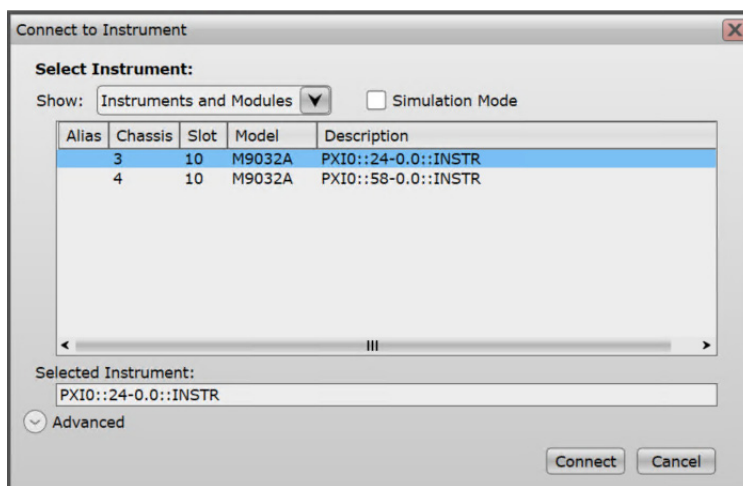

Figure 16 Viewing module connections in M9032x SFP

NOTE

If the module and its slot location is not visible in the “Connect to Instrument” dialog box, close the SFP and perform the steps described in the “Verifying M9032A connection” section. After running Keysight Connection Expert, you may restart the SFP.

- 3 From the main menu of the M9032x SFP, click **Utilities** > **Self Test...**

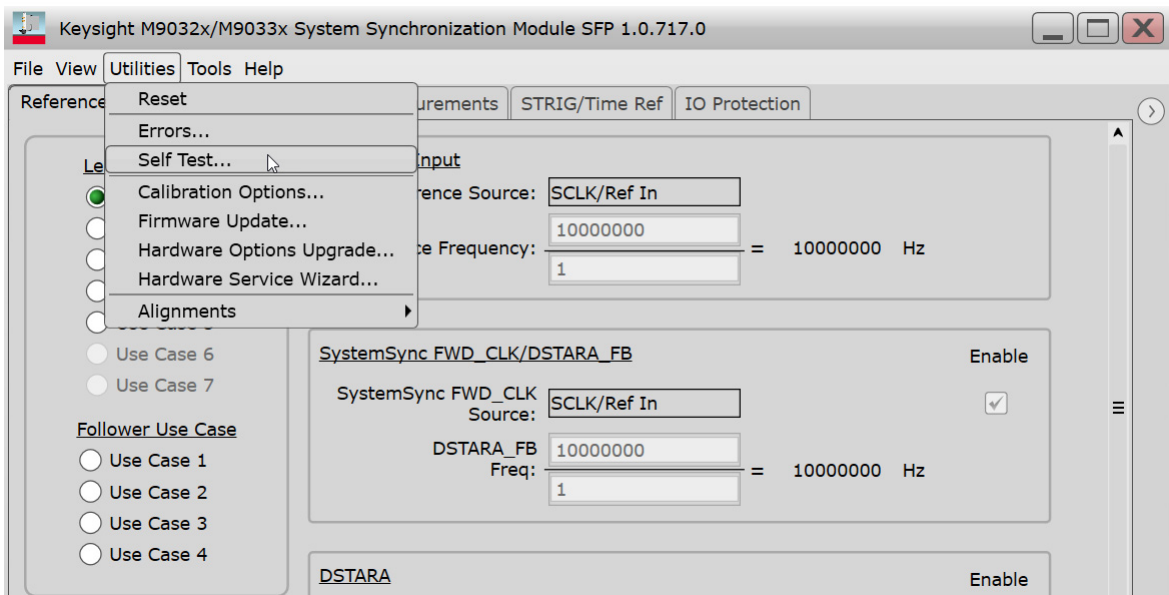

Figure 17 Initiating self test in M9032x SFP

- 4 On the **Self Test** window that appears, click **Run Self Test**.
If the self test is successful, the Self Test window appears as shown below.

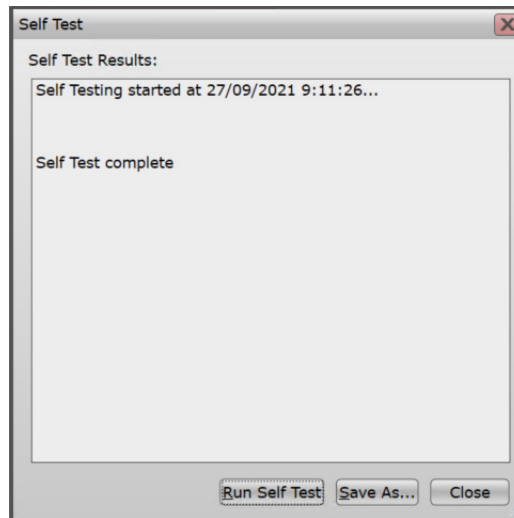

Figure 18 Self test passed status on the selected M9032A module

5 Click **Close** to exit the **Self Test** window.

If the Self Test fails, it indicates that the module likely needs service. In such cases, you must return the faulty module. Refer to "[Returning the Module for Service](#)" on page 24.

Section 2.4: Cleaning the module

WARNING

Do not attempt to clean the card. If cleaning is absolutely necessary, to prevent electrical shock, disconnect the power cord from the mains before removing the modules from the chassis.

- 1 Power off the chassis and remove the M9032A / M9033A modules.
- 2 Use either a dry lint free cloth, or compressed air to clean the front plate (face-plate) only of the M9032A / M9033A modules.
- 3 If a damp cloth is used, or if there is condensation from the compressed air, make sure that the card is completely dry before reinserting the card into the chassis.

3. Setting up the M9032x software

[Prerequisites to setting up M9032x software](#) / 44

[Downloading and installing M9032x software](#) / 45

[Launching the software](#) / 51

Section 3.1: Prerequisites to setting up M9032x software

3.1.1: System requirements

- Windows 10 (x64 bit)

3.1.2: Prerequisite software requirements

Table 8 Software to be installed prior to M9032x

Sequence	Prerequisite software	Web Page to download installer from	License
1	Keysight IO Libraries Suite 2022 (version 18.2.27313.1 or later)	Click this link to be redirected to the page	Free
2	Python 64-bit version 3.7, 3.8, 3.9 and 3.10. Multiple versions supported	Download from the official website for Python	–
3	PXIe Chassis firmware	–	–
4	PXIe Chassis Family Drivers (version 1.7.402.1 or later)	Click this link to be redirected to the page	–

General installation steps for prerequisite software

Perform these steps for installing the software in the sequence shown in [Table 8](#).

- 1 Click the download link and save the installer.
- 2 Run the downloaded installer.
- 3 Follow the on-screen instructions.

For PXIe Chassis drivers and firmware

- 1 When installing the Keysight Chassis Family Driver, PXIe Chassis SFP (Software Front Panel) software is automatically installed.
 - Chassis firmware version can be checked and updated using PXIe Chassis SFP.
- 2 For any other chassis model being used, Keysight recommends installing the required firmware version and its compatible chassis driver separately.

Section 3.2: Downloading and installing M9032x software

The following sections show installation procedure for each software in the sequence listed in [Table 8](#). Before you begin installing the M9032x software, you must ensure that all other software listed in “[Prerequisite software requirements](#)” on page 44 are installed on the same machine.

3.2.1: Downloading the M9032x software

You may download the installer from

<https://www.keysight.com/find/M9032A-Drivers>

or

<https://www.keysight.com/find/M9033A-Drivers>

3.2.2: Installing the M9032x software

- 1 After you have downloaded the executable file from Keysight.com, double-click the installer for M9032x Software.

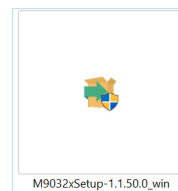

Figure 19 Icon for the M9032x software installer

The Welcome screen on the M9032x Setup Wizard appears.

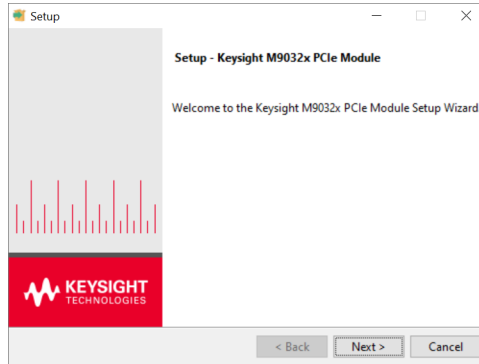

Figure 20 Welcome window on the M9032x Setup Wizard

- 2 Click **Next >**. The terms of the License Agreement are displayed.

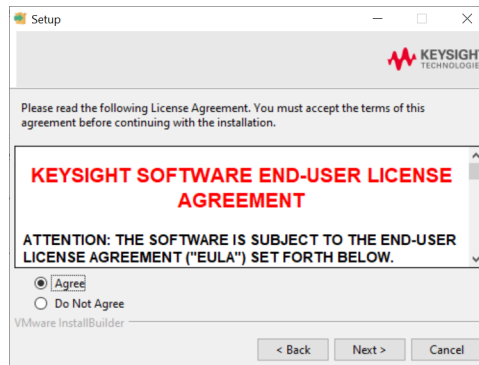

Figure 21 License Agreement window on the M9032x Setup Wizard

- 3 Select **Agree** to proceed.
- 4 Click **Next >**.

Based on your preferences, the Setup window displays various components of the M9032x SW that you may select to install or clear to refrain from installation. Clearing components from installation helps you save disk storage space on your machine. Selecting / clearing one or more entries is optional.

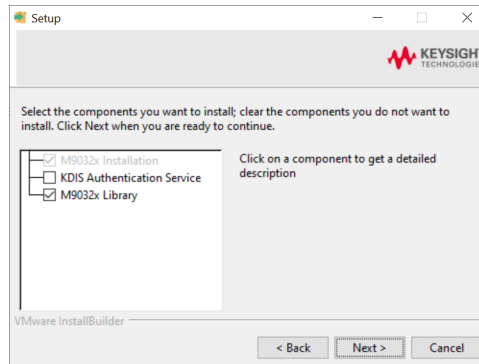

Figure 22 Selecting / clearing components during M9032x SW installation

By default, all components but KDIS Authentication Service are selected.

If you wish to set your machine as the KDIS root node, select the “KDIS Authentication Service” component. For more information about Keysight Distributed Infrastructure Service (KDIS), refer to the *M9032A / M9033A System Sync Modules User Guide*.

- 5 Click **Next >**. The Setup window informs you that the wizard is ready to begin installation of the M9032x SW drivers.

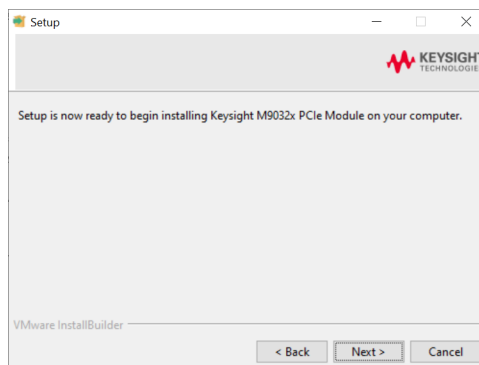

Figure 23 Information displayed on the M9032x Setup Wizard

- 6 Click **Next >**. A progress bar appears indicating the installation status.

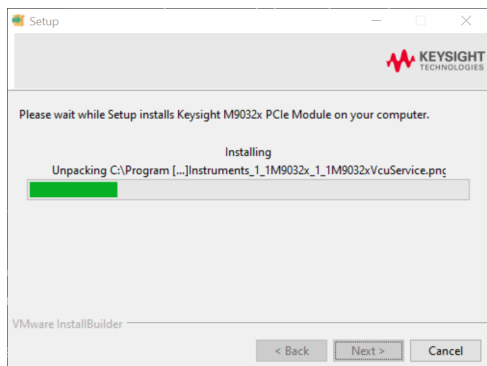

Figure 24 Progress bar on the M9032x Setup Wizard

The completion window on the M9032x Setup Wizard is displayed.

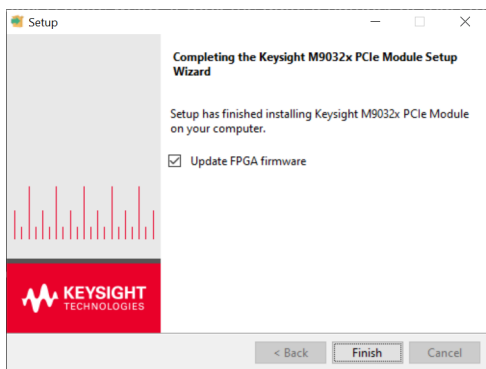

Figure 25 Completion window on the M9032x Setup Wizard

Note that the final window displays an option, which is enabled by default, to **Update FPGA firmware**. Perform one of the following steps:

- i With the **Update FPGA firmware** enabled, click **Finish** to complete the software installation, to exit the M9032x Setup Wizard and to allow the installer to proceed with updating the FPGA firmware revision on the M9032A / M9033A modules.

The following prompt is displayed during FPGA firmware update.

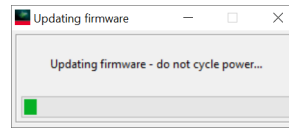

Figure 26 Updating firmware prompt in the M9032x Setup Wizard

Click **OK** to exit the **Info** prompt and perform a power cycle as instructed.

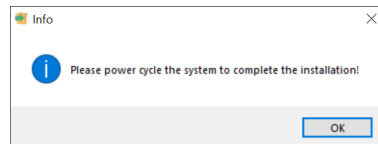

Figure 27 Updating firmware prompt in the M9032x Setup Wizard

- ii Clear the **Update FPGA firmware** check box, click **Finish** to complete the software installation and exit the M9032x Setup Wizard.

3.2.3: Installing M9032A / M9033A module firmware updates

Prerequisite

The Keysight M9032x software must be installed to update your module firmware.

Downloading the Firmware

The latest firmware for the M9032A / M9033A module is downloaded along with the Keysight M9032x software package, each time you download a new version.

Modifying the Firmware

Based on your programming requirements, you may either upgrade or downgrade the Firmware version on an M9032A / M9033A module.

- 1 Launch the Keysight M9032x SFP software from the **Start** menu.
- 2 From the main menu of the M9032x software, click **Utilities** > **Firmware Update...**

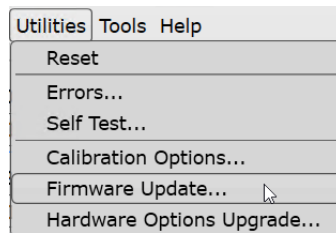

Figure 28 Accessing Firmware Update option in SFP

NOTE

Currently, the firmware version on the M9032A / M9033A modules is up-to-date. The next firmware version will be available in the next release of the M9032x software.

Section 3.3: Launching the software

3.3.1: Launching the M9032x user interface

Once you have installed the Keysight M9032x software, you can launch the Soft Front Panel (SFP) from the **Start** menu.

- 1 On your Win10 OS, click **Start > Keysight M9032x PCIe Module > M9032x SFP (x64)**.

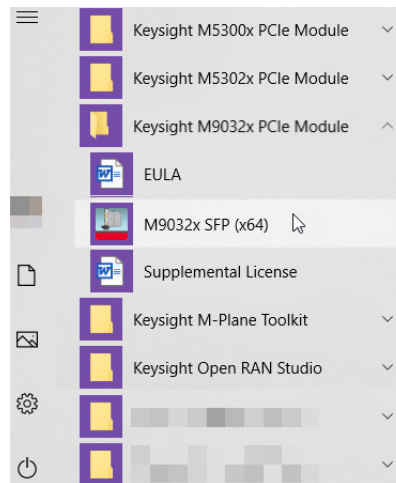

Figure 29 Launching SFP from the Start Menu

The Connect to Instrument window is displayed, as shown in [Figure 30](#) and [Figure 31](#).

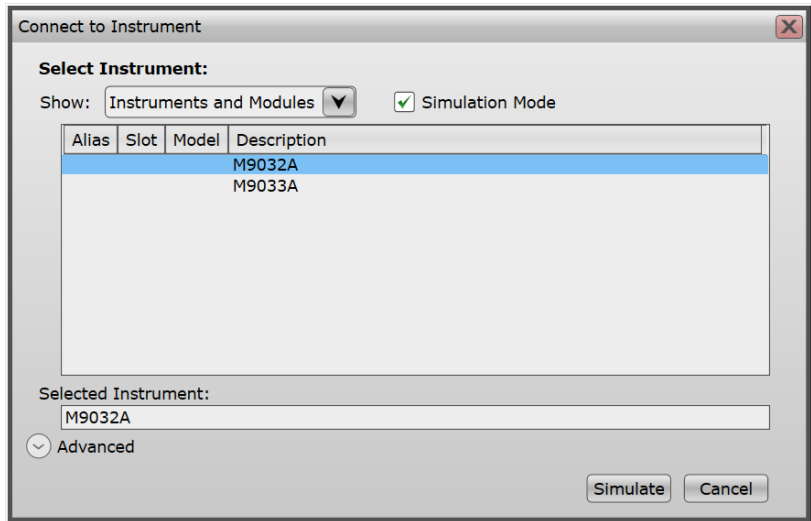

Figure 30 Simulation mode without any active cards (offline mode)

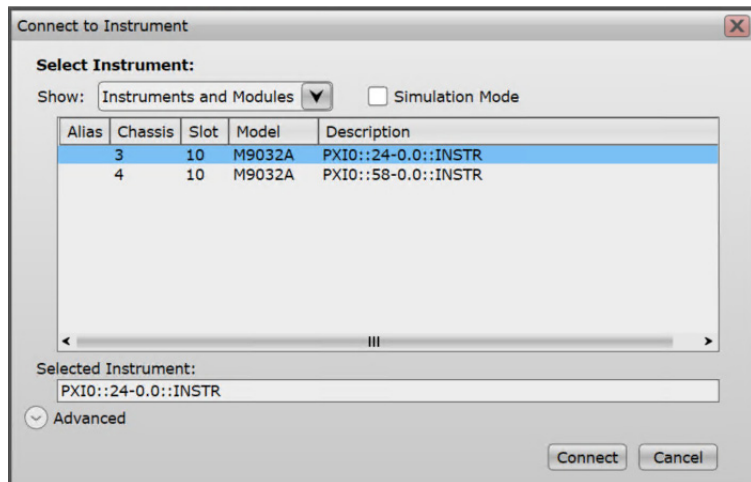

Figure 31 Default window with active cards (online mode)

As shown in [Figure 31](#), while launching, the Keysight M9032x software auto-detects any active M9032A / M9033A cards that are connected to the chassis. All such cards are displayed along with the chassis, slot number and VISA address on the **Connect to Instrument** window.

There are two modes that the M9032x SFP can be operated in.

- ‘Simulation mode’ enabled—This is the default mode of SFP operation. The **Simulation Mode** check box is selected by default and the **Simulate** button is displayed on the window. As the name indicates, this mode is used for offline SFP operations. In this mode, even if you select an active module (which is connected to a chassis in powered on state), toggling the SFP controls does not affect the signal state on the module. The status bar on the main window shows ‘Simulation Mode’, as shown in [Figure 32](#).

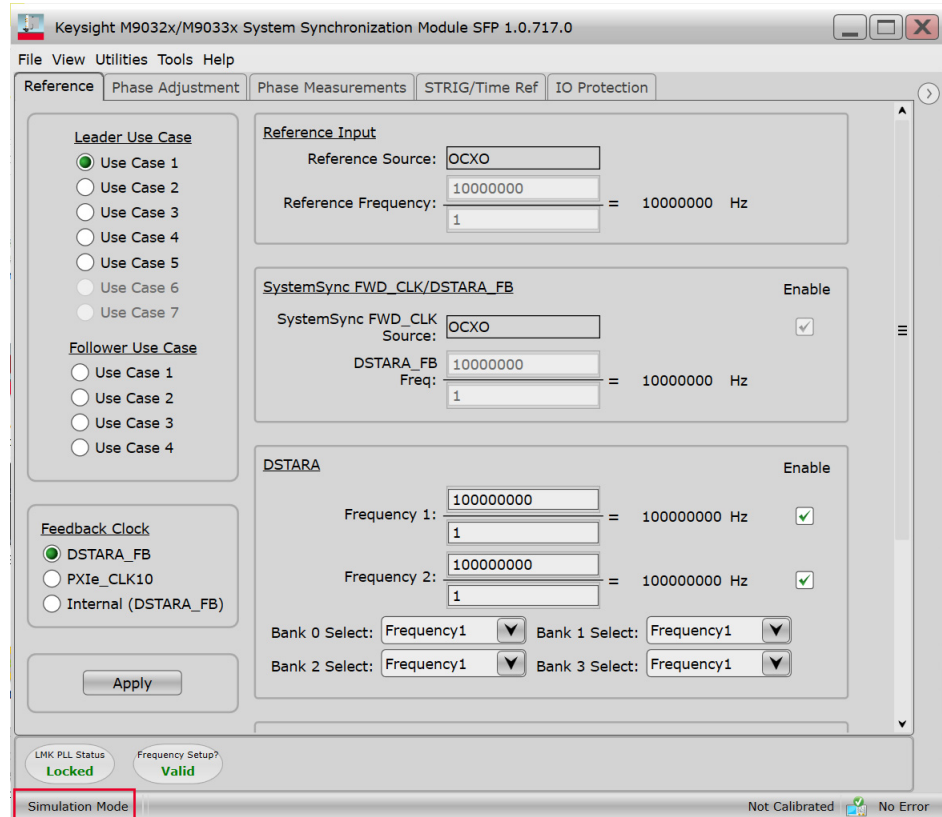

Figure 32 “Simulation Mode” in the status bar on the main window

Note that a demo 'M9032A' module only is displayed in [Figure 30](#) and in [Figure 31](#) along with other active cards. This entry appears when "Simulation Mode" is enabled only, irrespective of state of the chassis (On / Off) or the modules inserted in them.

- 'Simulation mode' disabled—This is the active mode of SFP operation and is available when the **Simulation Mode** check box is clear. The **Simulate** button is replaced with the **Connect** button on the **Connect to Instrument** window, as shown in [Figure 33](#). In this mode, only the active modules are displayed along with the respective chassis number, slot number and VISA address.

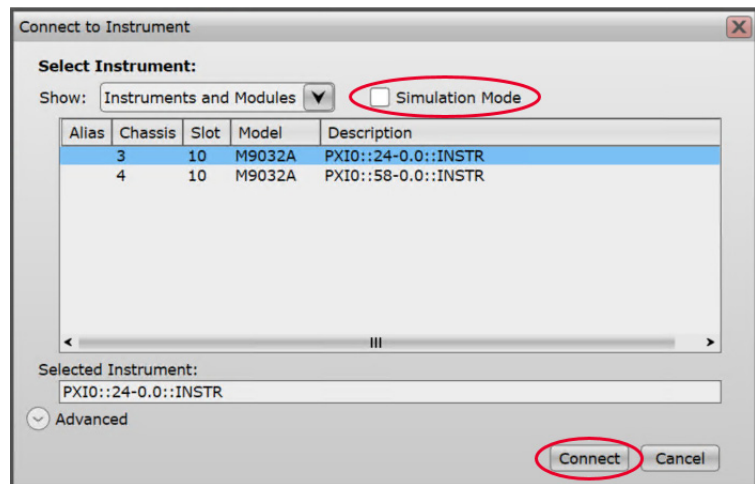

Figure 33 Connect to Instrument with "Simulation Mode" disabled

This mode is used for active SFP operations. In this mode, toggling the SFP controls changes the signal state on the selected module. The status bar on the main window shows 'Connected to <VISA-address>' to indicate the module that has been selected, as shown in [Figure 34](#).

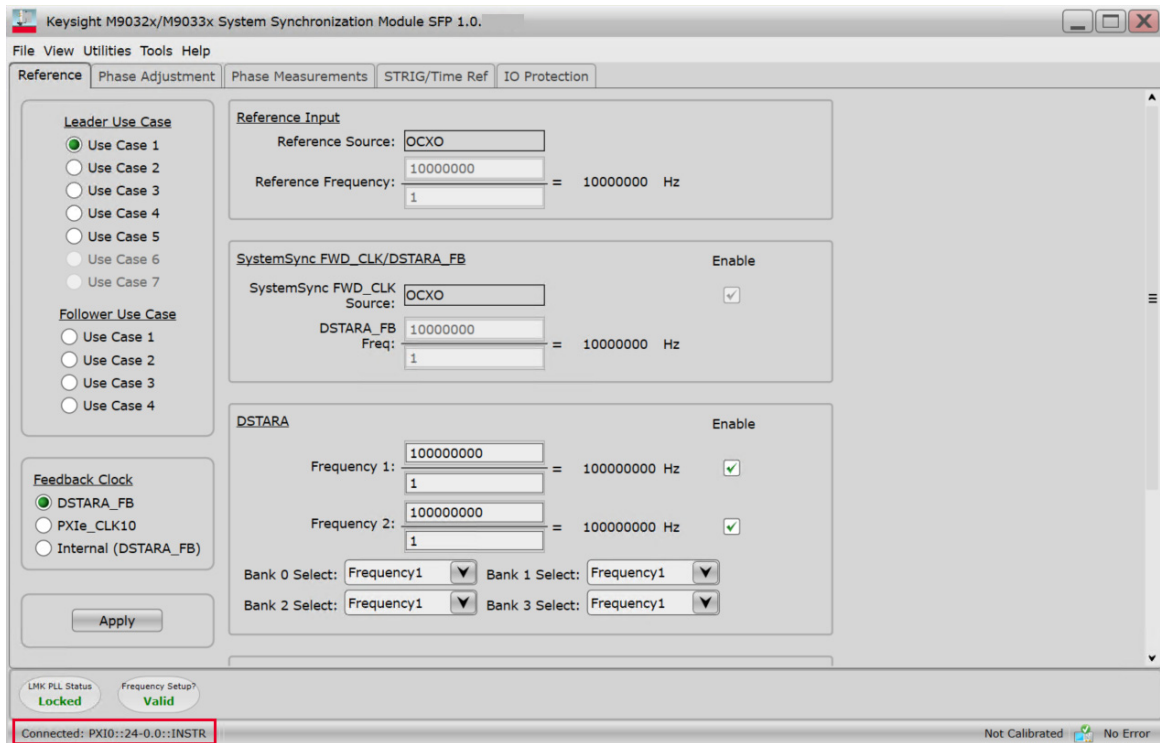

Figure 34 “Connected to <VISA address>” in the status bar on the main window

For more information regarding the features and functionality of the Keysight M9032x SFP, refer to the *M9032A/M9033A System Sync Modules User’s Guide*, which can be accessed via the **Help** menu of the M9032x SFP.

3.3.2: Programming with M9032x API

You may access the M9032x API to control and configure the connected instruments using the 'ktM9032x' Library available in Python, C/C++ and .NET programming languages.

The following example, using C++ commands, shows how to use Keysight M9032x Programming Libraries:

```
#include "KtM9032x.h"
#include <iostream>
using namespace Keysight::KtM9032x;
using namespace std;
int32_t main()
{
    const auto resource = "pxi25::0::0::instr";
    const auto query = true;
    const auto reset = true;
    const auto options = "simulate=true, DriverWrapper=";
    auto api = make_shared<KtM9032x>(resource, query, reset, options);
    cout << "Identifier   " << api->Identity()->GetIdentifier() << endl;
    cout << "Version       " << api->Identity()->GetInstrumentFirmwareRevision() << endl;
    cout << "Manufacturer  " << api->Identity()->GetInstrumentManufacturer() << endl;
}
```

For more information regarding M9032x API programming functions, refer to the Help files, which are available in *C:\Program Files\Keysight\M9032x*, for each programming language.

4. Troubleshooting and Safety information

[Troubleshooting installation issues](#) / 58

[Safety information](#) / 59

Section 4.1: Troubleshooting installation issues

- If installing the complete/hardware install and the installer is stalling for long periods or failing installing Keysight IO Libraries, try downloading and installing Keysight IO Libraries directly from <https://www.keysight.com/find/iolib>.
- For Keysight support for help with tools and documentation or to connect with a technical support expert for product and service support, see <https://www.keysight.com/find/support>.

Section 4.2: Safety information

IMPORTANT

The safety of any system incorporating the equipment is the responsibility of the assembler of the system.

Maintenance To remove dirt or dust from the M9032A / M9033A modules, follow the instructions given in [Cleaning the module](#) on page 41 of this document.

4.2.1: General safety considerations

Before applying power

WARNING

If this product is not used as specified, the protection provided by the equipment could be impaired. This product must be used in a normal condition (in which all means for protection are intact) only.

CAUTION

The measuring terminals on this instrument are designed to be used with external signals described in Mains-isolated secondary circuits, but NOT with external signals described in Categories II, III, and IV. The input of this instrument cannot be connected to the mains.

Table 9 Description of Measurement Category II, III and IV

Measurement Category	Description
II	Applicable to testing and measuring circuits connected directly to utilization points (socket outlets and similar points) of the low-voltage mains installation. Example: Measurements on MAINS CIRCUITS of household appliances, portable tools and similar equipment and on the consumer side only of socket-outlets in the fixed installation.
III	Applicable to test and measuring circuits connection to the distribution part of the building's low-voltage mains installation. To avoid risks caused by the hazards arising from these higher short-circuit currents, additional insulation and other provisions are required. Example: Measurements on distribution boards (including secondary meters), photovoltaic panels, circuit breakers, wiring, including cables, bus-bars, junction boxes, switches, socket-outlets in the fixed installation, equipment for industrial use and some other equipment such as stationary motors with permanent connection to the fixed installation. NOTE: For equipment that is part of a fixed installation, the fuse or circuit breaker of the installation can be considered to provide adequate protection against short-circuit currents.
IV	Applicable to test and measuring circuits connected at the source of the building's low-voltage mains installation. Due to these high short-circuit currents, which can be followed by a high energy level, measurements made within these locations are extremely dangerous. Great precautions shall be made to avoid any chance of a short circuit. Example: Measurements on devices installed before the main fuse or circuit breaker in the building installation.

Servicing

WARNING

Servicing of the modules must be performed by qualified personnel only. To avoid electrical shock, do not perform any servicing manually. Return the module to Keysight Service Center.

Equipment and accessories

WARNING

For safety reasons, only Keysight approved equipment and accessories should be used with the module.

NOTE

Position chassis to ensure easy access to remove the modules.

This information is subject to
change without notice.
© Keysight Technologies 2023
Edition 1.1, May 2023



M903X-91003

www.keysight.com